



Radioddity

Two Way Radio

GC-5 SERIES

User Manual

PREFACE

Thank you for purchasing this product. which is a dual-band/dual display/dual watch. This easy-to-use radio will deliver you secure, instant and reliable communications at peak efficiency. Please read this manual carefully before use. The information presented herein will help you to derive maximum performance from your radio.



WARNING! European Users should note that operation of this unit in Transmit mode requires the operator to have a valid Amateur Radio License from their respective Countries' Amateur Radio Licensing Authority for the Frequencies and Transmitter Power levels that this Radio transmits on. Failure to comply may be unlawful and liable for prosecution. On this subject, refer to the “EU” specification guide 2014/53/EU.



ATTENTION! When programming the radio, start by reading the factory software data, and then rewrite this data with your frequency etc., to a new saved code plug, otherwise errors may occur. You can use the programming cable with a PC to program the authorized frequency, bandwidth, power, etc. your programming must comply with your FCC (or EU other country) license certification.



ATTENTION! *Before using this product, read the RF Energy Exposure and Product Safety Guide that ship with the radio which contains instructions for safe usage and RF energy awareness and control for compliance with applicable standards and regulation.*



PMR446, FRS, GMRS, MURS

You may be tempted to use PMR446 (in Europe) or FRS, GMRS, or MURS (in the USA) frequencies. Do note however that there are restrictions on these bands that make this transceiver illegal for use.

Table of Contents

Chapter1. Getting Started			
1.1 Regulations and Safety Warnings	01	5.2 Adjusting the volume	14
1.2 Content of the packaging	05	5.3 Making a call	14
1.3 Main features	06	5.4 Channel selection	14
Chapter2. Charging the Battery		5.5 Frequency (VFO) mode	15
2.1 Charging the Battery Pack	06	5.6 Channel (MR) mode	15
2.2 Charger Supplied	06	5.10 FM Radio (FM)	17
2.4 How to Charge	07	5.15 One touch frequency Search	18
2.5 LED Indicator	07	5.16 Weather Radio/Scan Weather Channel	18
2.6 How to Store the Battery	08	Chapter6. Advanced Features	
Chapter3. Installation of Accessories		6.1 Working the menu system	19
3.1 Installing / Removing the Antenna	09	6.2 Scanning	20
3.2 Installing the belt clip	09	6.3 Manual Programming	22
3.3 Installing the battery pack	09	6.4 Repeaters Programming	24
3.4 Additional Speaker/Microphone (Optional)	09	6.5 VOX	25
Chapter4. Radio Overview		6.6 Dual Watch	25
4.1 Buttons and controls of the radio	10	6.7 Stopwatch timer	26
4.2 LCD Display	11	6.8 DTMF	26
4.3 Status Indications	12	6.9 Customization	27
4.4 Main keypad controls	12	6.10 Reset	29
Chapter5. Basic Operations		Appendix A. - Trouble shooting guide	30
5.1 Power on the radio	13	Appendix B. - Shortcut Menu operations	31
		Appendix C. - Technical Specifications	37

Chapter 1. Getting Started

1.1 Regulations and Safety Warnings

■EU Regulatory Conformance

As certified by the qualified laboratory, the product is in compliance with the essential requirements and other relevant provisions of the Directive 1999/5/EC (2014/53/EU). All applicable EU regulations are regarded (2006/66/EC, 2011/65/EU, 2012/19/EU). Please note that the above information is applicable to EU countries only.

■FCC Part15/IC Compliance

FCC Part 15 Compliance

This device complies with Part 15 of the FCC rules. Operation is subjected to the following two conditions: (1) this device may not cause harmful interference, and (2) this device must accept any interference received, including interference that may cause undesired operation.

Changes or modifications not expressly approved by the party responsible for compliance could void your authority to operate the equipment.

Avis de conformité à la FCC : Ce dispositif a été testé et s'avère conforme à l'article 15 des règlements de la Commission fédérale des communications (FCC). Ce dispositif est soumis aux conditions suivantes: 1) Ce dispositif ne doit pas causer d'interférences nuisibles et; 2) Il doit pouvoir supporter les parasites qu'il reçoit, incluant les parasites pouvant nuire à son fonctionnement.

Tout changement ou modification non approuvé expressément par la partie responsable pourrait annuler le droit à l'utilisateur de faire fonctionner cet équipement.

IC Compliance

This device complies with Industry Canada license-exempt RSS standard(s). Operation is subject to the following two conditions: (1) this device may not cause interference, and (2) this device must accept any interference, including interference that may cause undesired operation of the device.

Changes or modifications not expressly approved by the party responsible for compliance could void your authority to operate the equipment.

Cet appareil est conforme aux normes RSS exemptes de licences d'Industrie Canada. Son fonctionnement est soumis aux

deux conditions suivantes : (1) cet appareil ne doit pas causer d'interférences nuisibles et (2), il doit pouvoir accepter les interférences, incluant celles pouvant nuire à son fonctionnement normal.

Tout changement ou modification non approuvé expressément par la partie responsable pourrait annuler le droit à l'utilisateur de faire fonctionner cet équipement.

■ FCC RF Exposure

WARNING! It is up to the user to properly operate this radio transmitter to ensure safe operation. Please adhere to the following:

Do not use the radio with a damaged antenna. If a damaged antenna comes into contact with the skin, a minor burn may result.

Please contact your local dealer for a replacement antenna.

Hand-Held Operation (Held-to-Face)

This device was evaluated for typical hand-held (held-to-face) operations with a 1 inch spacing from the front of the radio. For hand-held operation, the radio should be held 1 inch from the user's face in order to comply with FCC RF exposure requirements.

Body-Worn Operation

This device was evaluated for body-worn operations with the supplied belt-clip accessory. (All necessary accessories are included in the package; any additional or optional accessories are not required for compliance with the guidelines.) Third-party accessories (unless approved by the manufacturer) should be avoided as these might not comply with FCC RF exposure guidelines.

For bodyworn operation, this device has been tested and meets the Industry Canada RF exposure guidelines when used with our company accessories supplied or designated for this product. Use of other accessories may not ensure compliance with Industry Canada RF exposure guidelines.

Fonctionnement de l'appareil, lorsque porté sur le corps. Cet appareil a été testé et s'est avéré conforme aux normes d'Industrie Canada et approuvé pour le port sur le corps à l'aide des accessoires notre société inclus et conçus pour cet appareil. L'utilisation d'accessoires ne respectant pas les exigences d'exposition RF d'Industrie Canada doit être évitée.

■ Precautions for Portable Terminals

Operating Prohibitions

To protect you against any property loss, bodily injury or even death, be sure to observe the following safety instructions:

1. Do not operate the product in a location containing fuels, chemicals, explosive atmospheres and other flammable or explosive materials. In such location, only an approved Ex-protection model is allowed for use, but any attempt to assemble or disassemble it is strictly prohibited.
2. Do not operate the product near or in any blasting area.
3. Do not operate the product near any medical or electronic equipment vulnerable to RF signals.
4. Do not hold the product while driving.
5. Do not operate the product in any area where wireless communication equipment is completely prohibited.

Important Tips

To help you make better use of the product, be sure to observe the following instructions:

1. Do not use any unauthorized or damaged accessories.
2. Keep the product at least 2.5 centimeters away from your body during transmission.
3. Do not keep the product receiving at high volume for a long time.
4. For vehicles with an airbag, do not place the product in the area over the airbag or in the airbag deployment area.
5. Keep the product and its accessories out of reach of children and pets.
6. Please operate the product within the specified temperature range.
7. Continuous transmission for a long time may lead to heat accumulation within the product. In this case, please keep it at a proper location for cooling.
8. Handle the product with care.
9. Do not disassemble, modify or repair the product and its accessories without authorization.

■Precautions for Batteries

Charging Prohibitions

To protect you against any property loss, bodily injury or even death, be sure to observe the following safety instructions:

1. Do not charge or replace your battery in a location containing fuels, chemicals, explosive atmospheres and other flammable or explosive materials.
2. Do not charge your battery that is wet. Please dry it with a soft and clean cloth prior to charging.
3. Do not charge your battery suffering deformation, leakage and overheating.
4. Do not charge your battery with an unauthorized charger.
5. Do not charge your battery in a location where strong radiation is present.

6. Overcharge shall always be prohibited for it may shorten the life of your battery.

Maintenance Instructions

To help your battery work normally or prolong its life, be sure to observe the following instructions:

1. Accumulated dust on charging connector may affect normal charging. Please use a clean and dry cloth to wipe it on a regular basis.
2. It is recommended to charge the battery under 5°C~40°C. Violation of the said limit may cause battery life reduction or even battery leakage.
3. To charge a battery attached to the product, turn it off to ensure a full charge.
4. Do not remove the battery or unplug the power cord during charging to ensure a smooth charging process.
5. Do not dispose of the battery in the fire.
6. Do not expose the battery to direct sunlight for a long time nor place it close to other heating sources.
7. Do not squeeze and penetrate the battery, nor remove its housing.

Transportation Instructions

1. Damaged batteries must not be transported.
 2. To avoid short circuit, separate the battery from metal parts or from each other if two or more batteries are transported in one packaging.
 3. The radio must be switched off and secured against switch-on, if the battery is attached.
- The content of the shipment must be declared in the shipping documents and by a Battery Shipping Label on the packaging. Contact your hauler for the local regulations and further information.

Maintenance

Your Two Way Radio is an electronic product of exact design and should be treated with care.

The suggestions below will help you to fulfill any warranty obligations and to enjoy this product for many years.

- Do not attempt to open the radio for any reason! The radio's precision mechanics and electronics require experience and specialized equipment; for the same reason, the radio should under no circumstances be realigned as it has already been calibrated for maximum performance. Unauthorized opening of the transceiver will void the warranty.
- Do not store the Radio under the sunshine or in hot areas.
- High temperatures can shorten the life of electronic devices, and warp or melt certain plastics.
- Do not store the radio in dusty and dirty areas.

- Keep the Radio dry. Rainwater or damp will corrode electronic circuits.
- If it appears that the Radio diffuses peculiar smell or smoke, please shut off its power immediately and take off the charger or battery from the radio.
- Do not transmit without antenna.

1.2 Main features

- Frequency range: FM radio 78-108 MHz; 144-148MHz (RX) ;420-450MHz (RX)
- One touch search frequency, easy pairing and grouping (copying channel configuration parameters)
- Frequency step, selectable between 2.5K | 5.0K | 6.25K | 10.0K | 12.5K | 20.0K | 25.0K | 50.0K
- Frequency hopping to keep your call privacy confidential
- 1.77" TFT large screen, full keyboard, fully open menu operation
- Channel scan, frequency scan, and three scan and recovery methods: TO, CO, and SE
- Up to 999 memory channels.
- Power-on password management function
- DTMF encoder and DTMF manual dial
- VOX (voice activated transmit).
- Alarm function.
- High or low power selectable.
- Programmable repeater offset.
- Transmission time-out timer.
- LED flashlight.
- End of transmission tone, aka "Roger Beep"
- Support NOAA weather reception function in the United States and Canada
- Broadcast FM radio receiver 78-108 MHz
- Dual watch / Dual reception/ Dual-band handheld transceiver
- High Capacity Lithium-Ion battery.
- Stopwatch function
- Display illumination programmable via keypad.
- Function beep on the keyboard.
- Battery save function.
- Busy channel lock out.
- Ten (10) levels of Squelch adjustment.
- Two (2) pins for Kenwood accessory port

1.3 Content of the packaging

- 1 Radio
- 1 Fast desktop charger
- 1 Antenna
- 1 Li-Ion battery pack
- 1 Belt clip

If any item is missing, please verify with your dealer.

Chapter 2. Charging the Battery

2.1 Charging the Battery Pack

The Li-ion battery pack is not charged at the factory; please charge it before use. Charging the battery pack for the first time after purchase or extended storage (more than 2 months) may not bring the battery pack to its normal maximum operating capacity. The best operation will require fully charging/ discharging the battery two or three times before the operating capacity will reach its best performance. The battery pack life may be depleted when its operating time decreases even though it has been fully and correctly charged. If this is the case, replace the battery pack.

2.2 Charger Supplied

Please use the specified charger provided by our company. Other models may cause explosion and personal injury. After installing the battery pack, and if the radio displays low battery with a voice prompt, please charge the battery.

2.3 Use Caution with the Li-ion Battery

- Do not short the battery terminals or throw the battery into a fire. Never attempt to remove the casing from the battery pack, as our company cannot be held responsible for any accident caused by modifying the battery.
- The ambient temperature should be between 5°C-40°C (40°F - 105°F) while charging the battery. Charging outside this range may not fully charge the battery.
- Please turn off the radio before inserting it into the charger. It may otherwise interfere with correct charging.
- To avoid interfering with the charging cycle, please do not cut off the power or remove the battery during charging until the green light is on.

- e. Do not recharge the battery pack if it is fully charged. This may shorten the life of the battery pack or damage the battery pack.
- f. Do not charge the battery or the radio if it is damp. Dry it before charging to avoid damage.



WARNING !

When keys, ornamental chains or other electric metals contact the battery terminal, the battery may become damaged or injure a human. If the battery terminals are short-circuited it will generate a lot of heat. Take care when carrying and using the battery. Remember to put the battery or radio into an insulated container. Do not put it into a metal container.

2.4 How to Charge

- a. Plug the AC adaptor into the AC outlet, and then plug the cable of the AC adaptor into the DC jack located on the back of the charger. The indicator light blinks orange and is then ready to charge a battery.
- b. Plug the battery or the radio into the charger. Make sure the battery terminals are good in contact with charging terminals. The indicator light turns to red--- charging begins.
- c. It takes approximately 2-5 hours to fully charge the battery. When the lamp lights green, the charging is completed. Remove the battery or the radio unit with its battery from socket.

When charging a radio (with battery) the indicating lamp will not turn green to show the fully charged status if the radio is powered on. Only when the radio is switched off will the lamp indicate normal operation. The radio consumes energy when it is power on, and the charger cannot detect the correct battery voltage when the battery has been fully charged. So the charger will charge the battery in constant voltage mode and fail to indicate correctly when the battery has been fully charged.

2.5 LED Indicator

STATUS	LED
No Battery	Green and red alternately flashing
Charge Normally	Red
Fully Charged	Green
Trouble	Red blinks fast for a long time

NOTE: *Trouble means battery too warm, battery short-circuited or charger short-circuited.*

2.6 How to Store the Battery

- a. If the battery needs to be stored, keep it in status of 80% discharged.
- b. It should be kept in low temperature and dry environment.
- c. Keep it away from hot places and direct sunlight.
 - » Do not short circuit the battery terminals.
 - » Never attempt to remove the casing from the battery pack.
 - » Never store the battery in unsafe surroundings, as a short may cause an explosion.
 - » Do not put the battery in a hot environment or throw it into a fire, as it may cause an explosion.

Useful Tips:

1. Tighten screws fully to prevent loosening and maintain waterproof performance.
2. Ensure buckle is securely placed in seat charger groove (listen for a "click" and no side-to-side movement).



Chapter 3. Installation of Accessories

Before the radio is ready for use we need to attach the battery pack, as well as charge the battery.

3.1 Installing/ Removing the Antenna

- a. Installing the Antenna: Screw the antenna into the connector on the top of the transceiver by holding the antenna at its base and turning it clockwise until secure.
- b. Removing the Antenna: Turn the antenna counter-clockwise to remove it.

3.2 Installing the belt clip

- a. At the back of the radio there are two parallel screws mounted above the battery, remove these and thread them through the holes on the belt clip as you screw them back into the radio body.
- b. Removing the Belt Clip: Unscrew counter-clockwise to remove the belt clip.

3.3 Installing the battery pack

Before attaching or removing the battery make sure your radio is turned off by turning the power/volume knob all the way counterclockwise.

- a. Make sure the battery is aligned in parallel with the radio body with the lower edge of the battery about 1-2cm below the edge of the radio.
- b. Once aligned with the guide rails, slide the battery upward until you hear a click as the battery locks in place.

Remove the battery pack

To remove the battery, press the battery release above the battery pack, as you slide the battery downward.

3.4 Installing the Additional Speaker/Microphone (Optional)

Pry open the rubber MIC-Headset jack cover and then insert the Speaker / Microphone plug into the double jack.

Chapter 4. Radio Overview

4.1 Buttons and controls of the radio

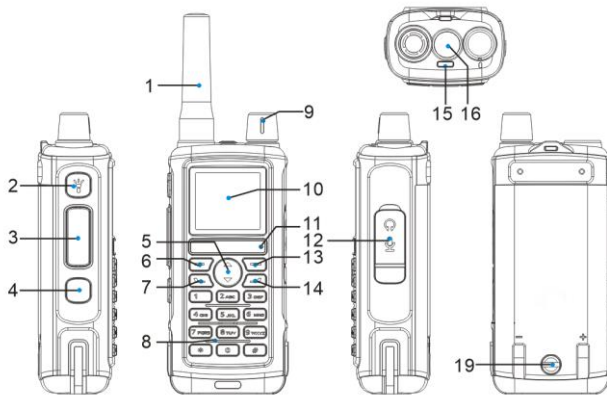

1. Antenna

4. SK2-FM broadcast/Monitor key

7. VFO/MR key

10. Color LCD

13. -EXIT Key

16. LED flashlight

2. SK1-Flashlight/ Emergency Alert key

5. ▲ or ▼ navigation keys

8. Numeric keypad

11. MIC Input

14. A/B key

19. Battery tightening screw

3. PTT key









6. -MENU key

9. Power / Volume knob

12. Speaker/Mic Jacks

15. LED Status Indicator

4.2 LCD Display

Icon	Description
RSSI	Squelch Open/ Close Indicator
H/L	Transmit power level indicator, According to Power (High/Low)
	Make sure you can hear the DTMF side tone from the radio speaker, set to DT-ST, ANI-ST, DT+ANI.
	DCS enabled
	CTCSS enabled
+	Enables access of repeaters in VFO/Frequency Mode. TX will be shifted higher in frequency than RX.
-	Enables access of repeaters in VFO/Frequency Mode. TX will be shifted lower in frequency than RX
D	Dual watch enabled
	Keypad lock enabled
	VOX enabled
	The confidential calling feature is activated
N	Narrowband enabled
	Battery level indicator
R	Reverse function enabled
	Indicates active band or channel

Battery Level Indicator

When the battery level indicator reads  the battery is depleted. At this point the radio will start beeping periodically as well as flash the backlight of the display and when voice prompts are enabled, a "Low Voltage" announcement will be heard, indicating that you need to change your battery or put your radio in the charger.

4.3 Status Indications

The status LED has a very simple and traditional design.

LED Indicator	Radio Status
Constant Red	Transmitting.
Constant Green	Receiving.

4.4 Main keypad controls

• Side key 1 (Flashlight and Alarm)

Press **[SK1]** key momentarily to turn on the LED flashlight. Another momentary press will flash the LED. Another momentary press turns the flashlight off.

Press and hold **[SK1]** key to activate the alarm function. Press **[SK1]** (a short press) again to turn it off



• Side key 2 (Broadcast FM and Monitor)

Press **[SK2]** key momentarily to start the broadcast FM receiver. Another momentary press turns the broadcast FM receiver off. If a signal is received on the active frequency or channel while you are listening to the broadcast FM, the receiver will open a squelch to that frequency (as if scanning) and remain there until the signal goes away; it will then switch back to broadcast FM.

Press and hold **[SK2]** to monitor the signal. This will open up the squelch so you can listen to the unfiltered signal.

• key

It is used for activating the MENU, choosing each MENU selection and confirming the parameter.

-  key: Press it for more than 2 seconds, the channel and frequency will move upwards rapidly; in SCAN mode, press this control to move the scanning upwards.
-  key: Keep it pressed it for more than 2 seconds, the channel and frequency will move downwards rapidly; in SCAN mode, press this control to move the scanning downwards.

• key

Press to exit the Menu and functions.

Press and hold the  key to activate the one-touch search function.

- **VFO/MR Key**

In standby mode, press the key to switch between frequency (VFO) mode and channel (MR) mode.

To save frequencies to channel memory you must be in Frequency (VFO) mode. Memory mode is sometimes also referred to as Channel mode.

- **A/B Key**

A/B (appears on the display): press to select the desired frequency (VHF or UHF) in the main or secondary display.

- **Numeric keypad**

With these keys you can input the information or your selections on the radio. In tx mode, press the number keys to send a corresponding DTMF code.

- **Star * Key**

A short momentary press of the key enables the reverse function.

If you press this key for more than 2 seconds you will lock/unlock the keypad.

- **Pound # Key**

Press the  key to activate the DTMF dial function.

Press and hold the  key to activate the channel scan or frequency scan function.

In FM radio mode, press the  **key** to automatically search for broadcast programs.

- **0 key**

Press and hold the  key to activate the NOAA weather forecast reception function

Chapter 5. Basic Operations

5.1 Power on the radio

- **Turning the unit on**

To turn the unit on, simply rotate the Volume/Power knob clockwise until you hear a "click". If your radio powers on correctly there should be an audible double beep after about one second and the display will show a message or flash the LCD depending on settings for about one second. Then it will display a frequency or channel. If the Voice prompt is enabled, the voice will announce "frequency mode" or "channel mode".

- **Turning the unit off**

Turn the Volume/Power knob counterclockwise all the way until you hear a "click". The unit is now off.

5.2 Adjusting the volume

To turn up the volume, turn the volume/power knob clockwise. To turn the volume down, turn the Volume/Power knob counterclockwise. Be careful not to turn it too far, as you may inadvertently turn your radio off.

By using the monitor function, enabled from the [FM broadcast/Monitor] key below the PTT, you can more easily adjust your volume by adjusting it to the un-squelched static.

5.3 Main Band/Sub Band Select

In standby mode, press the [A/B] key to switch between A (upper) and B (lower) displays. The frequency or channel on the selected display becomes the active listening and transmitting frequency or channel.

To save frequencies to channel memory you must be on the A display.

5.4 VFO/Channel Switch

Press the [VFO/MR] key to switch between VFO and channel display.

- In channel mode (MR), the channel number will be displayed on the right.
- In frequency mode (VFO), the 'VFO' will be displayed on the right.

5.5 Frequency (VFO) mode

In Frequency (VFO) mode you can navigate up and down the band by using the ▲ or ▼ keys. Each press will increment or decrement your frequency according to the frequency step you've set your transceiver to.

You can also input frequencies directly on your numeric keypad with kilohertz accuracy.

The following example assumes the use of a 12.5 kHz frequency step.

Example. Entering the frequency 436.61250 MHz on display A

(1) In standby mode, press [VFO/MR] key to the frequency (VFO) mode.

(2) Enter [4][3][6][6][1][2][5] [0] on the numeric keypad.

WARNING!

Just because you can program in a channel does not mean you're automatically authorized to use that frequency. Transmitting on frequencies you're not authorized to operate on is illegal and in most jurisdictions a serious offense. However, it is legal in most jurisdictions to listen. Contact your local regulatory body for further information on what laws, rules and regulations apply to your area.

5.6 Channel (MR) Mode and Channel Selection

There are two modes of operation: Frequency (VFO) mode, and Channel or Memory (MR) mode.

For everyday use, Channel (MR) mode is going to be a whole lot more practical than Frequency (VFO) mode. However, Frequency (VFO) mode is very handy for experimentation out in the field. Frequency (VFO) mode is also used for programming channels into memory.

In Channel (MR) mode you can navigate up and down the channel by using the ▲ or ▼ keys or the encoder.

Ultimately which mode you end up using will depend entirely on your use case.

Press the [VFO/MR] key to switch the radio between VFO and Channel mode, select Channel mode.

- **Operation 1:** Press the ▲ or ▼ navigation key to select the channel.
- **Operation 2:** Input the channel numbers by the keyboard. For example, if you want to switch to channel 12, input [0][1][2] a total of 3 digits, and it will switch to channel 12.

When the voice prompt function is enabled, the corresponding channel will be broadcast by voice.

5.7 Making a call

NOTE: Press the [A/B] key to switch the main channel to the other channel if there are 2 channels shown on the display. In standby mode, press the [VFO/MR] key to switch between frequency (VFO) mode and channel (MR) mode.

- **Channel mode call:** After selecting a channel, hold down the **[PTT]** key to initiate a call to the current channel. Speak into the microphone with normal tone. Making a call, the red LED is on.
- **Frequency mode call:** Press the **[VFO/MR]** key to switch to the frequency mode, input the working frequency within the allowable frequency range, and press and hold the **[PTT]** key to transmit on the current frequency. Speak into the microphone with normal tone. Making a call, the red LED is on.
- **Receive a call:** When you release the **[PTT]** key, you can answer it without any action.
When receiving a call, the green LED is on.

NOTE: To ensure the best reception volume, keep the distance between the microphone and the mouth at the time of transmission from 2.5 cm to 5 cm.

5.8 Using the Flashlight

You can use this radio in an emergency. If you press **[SK1]** key, the radio turns on the high-intensity LED flashlight on your radio.

- Your radio operates normally when the emergency strobe is activated.
 - (1) Press **[SK1]** key once, it will turn on continuously (Always On mode).
 - (2) And then, press **[SK1]** key once, the Strobe Light emits the emergency signal (Strobe emergency mode).
 - (3) And then, press **[SK1]** key once, the light will be turned off.

5.9 Emergency Alert

The Emergency Alert feature can be used to signal members in your group for help.



To activate the emergency alert function, press and hold the **[SK1]** key for 3 seconds. The radio will send out a loud siren sound and the flashlight will flash.

Press the **[SK1]** key to exit the emergency alert function.

WARNING: The Emergency Alert feature should only be used in the event of an actual emergency.

5.10 FM Radio (FM)

The frequency ranges to listen to the radio is 78-108MHz. When listening to broadcast FM, press  key switches between 65-75 MHz and 76-108 MHz band.

- (1) In frequency or channel mode, Press **[SK2]** key to turn on the radio.
- (2) Select the desired radio frequency with the  or  keys or input the frequency. Or
 - Press  to automatically search a radio station.
- (3) Press **[SK2]** key to exit FM radio.

Note: while you are listening to the radio, the frequency or channel of A / B receiving signal will automatically switch to the frequency or channel mode for normal transmitting and receiving.

When the signal disappears the radio will automatically switch again to FM radio mode.

5.11 Monitor

In standby, press and hold the **[SK2]** key to enter Monitor. When receiving matched carrier but the signaling or the signal is too weak, this function allows monitoring the weak signal.

Stop pressing the **[SK2]** key to turn off the speakers and return to standby mode.

» *If no signal, it will emit noise when pressing the [SK2] Key.*

5.12 Keypad lock

The radio features a keypad lock that locks out all keys except for the three side keys.

To enable or disable the keypad lock, press and hold  the key for about two seconds.

You can also enable it so that the radio automatically locks the keypad after ten seconds from the menu.

5.13 Frequency reversal

A short momentary press of the key enables the reverse function

If you for some reason want to listen to the repeater's input frequency instead, press  key momentarily and you'll reverse your transmit and receive frequencies.

» *After activating the frequency reversal function, the first line of the screen displays "R"*

5.14 TX Repeaters tone

Press **[PTT] + [SK2]** key to send 1750Hz repeaters tone. This function is useful for communications through repeaters.

If you have the keypad lock enabled on your radio, you can still send a 1750Hz tone the regular way without having to unlock your radio.

5.15 One touch frequency Search

(1) The radio will act as a receiver. Press and hold the  key, and the screen will display “SEARCH SEARCH...”

(2) If the transmitter continues to transmit and the unit receives an effective frequency (the strongest and most stable signal), the received frequency will be displayed. If there is a CTCSS or DCS, the CTCSS or DCS value is displayed, and if there is no CTCSS or DCS, NONE is displayed

(3) You can press the  key to save the Search frequency and CTCSS or DCS to the channel.







Note: During frequency Search, press the  key on the radio to switch between UHF or VHF bands.

5.16 Weather Radio/Scan Weather Channel

Your radio has an NOAA Weather Radio function, to enable the user to receive weather reports from designated NOAA stations. Your radio also has a NOAA Weather Scan function, to enable the user to scan all 10 channels of the NOAA Weather Radio.

(1) To turn the NOAA Weather Scan on, press and hold the **[0sq]** key for 3 seconds,  icon appears. The radio will go to Weather band mode.

(2) Press and hold the  key for 3 seconds to start automatic scanning of all 10 channels and stop on active channels. Pressing and holding the  key for 3 seconds during a NOAA weather scan will stop the scan.

(3) After stopping NOAA weather scan, it is allowed to manually select the weather channel by pressing the  or  key.

(4) To exit the Weather Radio broadcast mode, press the  key or **[PTT]** key.

Weather channel frequencies and names

Channel Number	RX Frequency MHz	Channel Number	RX Frequency MHz
<i>Wx -01</i>	162.550	<i>Wx -06</i>	162.500
<i>Wx -02</i>	162.400	<i>Wx -07</i>	162.525
<i>Wx -03</i>	162.475	<i>Wx -08</i>	161.650
<i>Wx -04</i>	162.425	<i>Wx -09</i>	161.775
<i>Wx -05</i>	162.450	<i>Wx -10</i>	163.275

NOTE: Weather Channels Wx 1 Thru 10, Receive-only channels for NOAA and Canadian weather broadcasts. You cannot transmit on these channels.

Chapter 6. Advanced Features









6.1 Working the menu system

For a complete reference on available menu items and parameters, see Appendix B, Menu definitions.

If your radio is set to Memory (MR) mode, the following menu items will not take any effect: STEP, TXP, W/N, CTCSS, DCS, S-CODE, PTT-ID, BCL, SFT-D, OFFSET, MEM-CH.

6.1.1 Basic use

Using the menu with arrow keys

1. Press the  key to enter the menu.
2. Use the  /  keys to navigate between menu items.
3. Once you find the desired menu item, press  again to select that menu item.
4. Use the  /  keys to select the desired parameter.
5. When you've selected the parameter you want to set for a given menu item;
 - a. To confirm your selection, press  and it will save your setting and bring you back to the main menu.
 - b. To cancel your changes, press  and it will reset that menu item and bring you out of the menu entirely.
6. To exit out of the menu at any time, press  the key.







6.1.2 Using short-cuts

As you may have noticed if you looked at Appendix B, *Menu definitions*, every menu item has a numerical value associated with it. These numbers can be used for direct access of any given menu item.

The menu is also organized in such a way that the ten most common functions are on top.

The parameters also have a number associated with them, see Appendix B, *Menu definitions* for details.



Using the menu with short-cuts

1. Press the  key to enter the menu.
2. Use the numerical keypad to enter the number of the menu item.
3. To enter the menu item, press the  key.
4. For entering the desired parameter you have two options:
 - a). Use the  /  keys as we did in the previous section; or
 - b). Use the numerical keypad to enter the numerical short-cut code.
5. And just as in the previous section;
 - a). To confirm your selection, press  and it will save your setting and bring you back to the main menu.
 - b). To cancel your changes, press  and it will reset that menu item and bring you out of the menu entirely.
6. To exit out of the menu at any time, press the  key.
7. All further examples and procedures in this manual will use the numerical menu shortcuts.

6.2 Scanning

The Radios feature a built-in scanner for the VHF and UHF bands. When in Frequency (VFO) mode it will scan in steps according to your set frequency step. In Channel (MR) mode it will scan your channels. At approximately three frequencies per second, it's not the fastest scanner in the world, but it is nonetheless a useful feature to have at times.







Dual Watch is inhibited while scanning

To enable the scanner, press and hold the  key for about two seconds. Press and hold the  key to exit scanning mode.

6.2.1 Scanning modes

The scanner is configurable to one of three ways of operation: Time, carrier or search, each of which is explained in further detail in their respective section below.

Setting scanner mode

1. Press the  key to enter the menu.
2. Enter **[2] [1]** on your numeric keypad to come to scanner mode.
3. Press the  key to select.
4. Use the  /  keys to select scanning mode.
5. Press the  key to confirm and save.
6. Press the  key to exit the menu.

• Time operation

In Time Operation (TO) mode, the scanner stops when it detects a signal, and after a factory preset time out, it resumes scanning.

• Carrier operation

In Carrier Operation (CO) mode, the scanner stops when it detects a signal, and after a factory preset time with no signal it resumes scanning.





• Search operation

In Search Operation (SE) mode, the scanner stops when it detects a signal.

To resume scanning you must press and hold the  key again.

6.2.2 Frequency scanning

This function can scan the frequency.

- a. In frequency mode, press  key for more than 2 seconds. The radio will start scanning the frequency according to the set frequency step.
- b. You can change the scanning direction with the  /  keys.
- c. Press  key to stop the scanning.

Note: for Scan mode, see Menu No.21.

6.2.3 Channel scanning

This function can scan the channels.

- In channels mode, press **#Z** key for more than 2 seconds. The radio will start scanning according to the channel you set.
- You can change the scanning direction with the **▲/▼** keys.
- Press **#Z** key to stop scanning.

Note: for Scan mode, see Menu No.21.

6.2.4 Scan CTCSS

The function allows scanning the frequencies with CTCSS tone enabled.

- In standby mode, press **[1][4]**, “Scan CTCSS” will appear on the display.
- Press **[1]** key and the scan of CTCSS tones will start.

NOTES: The function cannot be activated when the radio is set in Channel mode. The Scan will start only when the receiving band will detect a signal.

6.2.5 Scan DCS

This function allows scanning the frequencies with DCS code enabled.

- In standby mode, press **[1][5]**; the display will show “Scan DCS”.
- Press **[1]** key and the scan of DCS codes will start.

NOTES: The function cannot be activated when the radio is set in Channel mode. The Scan will start only when the receiving band will detect a signal.

6.3 Manual Programming (Channels Memory)

Memory channels are an easy way to store commonly used frequencies so that they can easily be retrieved at a later date. The radios feature 999 memory channels that each can hold: Receive and transmit frequencies, transmit power, group signaling information, bandwidth, ANI/ PTT-ID settings, and a six-character alphanumeric identifier or channel name ¹.

Frequency Mode vs. Channel Mode

In standby mode, press the **[VFO/MR]** key to switch between frequency (VFO) mode and channel (MR) mode.

These two modes have different functions and are often confused.

Frequency Mode (VFO): Used for a temporary frequency assignment, such as a test frequency or quick field programming if permitted.

Channel Mode (MR): Used for selecting preprogrammed channels.

















Ex 1. Programming a Channel Repeater Offset with CTCSS Tone

EXAMPLE New memory in Channel 10:

RX = **432.55000** MHz

TX = **437.55000** MHz (This is a (+ 5) Offset)

TX CTCSS tone 123.0

- Press the  key to switch between menus.
- Press the **[VFO/MR]** key to set the radio to VFO mode, and the VFO icon is displayed on the right.
-  **[3][1]**  **[1][0]**   **Deletes Prior Data in channel (Ex. 10)**
-  **[1][2]**  123.0   **Selects desired TX encode tone**
- Enter RX frequency (Ex. **43255000**)
-  **[3][0]**  **[1][0]** 
-->>  **Enter the desired channel (Ex 10)**
RX has been added
- Enter TX frequency (Ex. **43755000**)
-  **[3][0]**  **[1][0]** 
-->>  **Enter the same channel (Ex 10)**
TX has been added
- Press **[VFO/MR]** key to return to the MR mode and the channel number will reappear.

Ex 2. Programming a Simplex Channel with CTCSS tone

EXAMPLE New memory in Channel 10:

RX = **432.6625** MHz

TX CTCSS tone 123.0

- Press the  key to switch between menus.
- Press **[VFO/MR]** key to set the radio to VFO mode, and the VFO icon is displayed on the right.

c. [F1] [3][1] [F1] [1] [0] [F1] [M]

Deletes Prior Data in channel (Ex. 10)

d. [F1] [1][2] [F1] 123.0 [F1] [M]

Select desired TX encode tone (Ex 123 CTCSS)

-->>Use [M] to select Upper display

e. Enter RX frequency (Ex. 43266250)

f. [F1] [3][0] [F1] [1][0] [F1]

Enter the desired channel (Ex 10)

-->> [M]

Channel has been added

g. Press [VFO/MR] key to return to the MR mode and the channel number will reappear.

6.4 Repeaters Programming

The following instructions assume that you know what transmit and receive frequencies your repeater employs, and that you're authorized to use it.

a. Press [VFO/MR] key to set the radio to VFO mode, and the VFO icon is displayed on the right.

b. Use the numeric keypad to enter the repeater's output (your receiving) frequency.

c. Press the [F1] key to enter the menu.

d. Enter [2][9] on the numeric keypad to get to frequency offset.

e. Press [F1] key to select.

f. Use the numerical keypad to enter the specified frequency offset. See the section called "29 OFFSET - Frequency shift amount" for details.

g. Press [F1] key to confirm and save.

h. Enter [2][8] on the numeric keypad to get to offset direction.

i. Use the ▲/▼ keys to select + (positive) or - (negative) offset.

j. Press [F1] key to confirm and save.

k. Optional:

a). Save to memory, see the section called "Manual programming" for details.

b). Set up CTCSS; see the section called "CTCSS" for details.

l. Press [M] key to exit the menu. If everything went well, you should be able to make a test call through the repeater.

NOTE:

If you're experiencing problems making a connection to the repeater, check your settings and/or go through the procedure

again.

Certain Amateur Radio repeaters (especially in Europe) use a 1750Hz tone burst to open up the repeater. To see how this is done with the radios, see the section called “1750Hz Tone-burst”.

If you're still unable to make a connection, contact the person in charge of the radio system with your employer or your local amateur radio club, as the case may be.



If you for some reason want to listen to the repeater's input frequency instead, press  key momentarily and you'll reverse your transmit and receive frequencies.

This is indicated in the LCD on the radio with an R in the top row, next to the + and - for the offset direction.

6.5 VOX

This function allows hands-free conversations: just speak in the direction of the microphone and the communication will be automatically activated.

In standby mode, press  + 7. The screen will display “VOX”.

Press  key to enter the function. Press the  keys to turn off the VOX function or to select the VOX level (1-10), then press  key to confirm.

To return to the standby mode press  key.

NOTE: level 1 is the least sensitive while level 9 is the most sensitive. When the radio is in Scan or FM Radio mode, the VOX is not enabled.

6.6 Dual Watch

In certain situations, the ability to monitor two channels at once can be a valuable asset. This can be achieved in one of two ways. You can either have one receiver in your radio and flip-flop between two frequencies at a fixed interval (known as Dual Watch), or you can equip a radio with two receivers (known as Dual Receive or Dual VFO). The former method is cheaper to implement and far more common than the latter.

The Radios feature Dual Watch functionality (single receiver) with the ability to lock the transmit frequency to one of the two channels it monitors.

Enabling or disabling Dual Watch mode

1. Press the  key to enter the menu.

2. Enter 7 on the numeric keypad to get to **Dual Watch**.
3. Press $\boxed{=}$ key to select.
4. Use the \blacktriangle / \blacktriangledown keys to enable or disable.
5. Press the $\boxed{=}$ key to confirm.
6. Press the $\boxed{\text{OFF}}$ key to exit the menu.

6.7 Stopwatch timer

In standby mode, press $\boxed{=}$ + 44. The screen displays “STOP WATCH”.

Press $\boxed{=}$ to enter the function. Press the \blacktriangle / \blacktriangledown keys to enable (ON) the function, then press $\boxed{=}$ key for confirmation.

To return to the standby mode press $\boxed{\text{OFF}}$ key.

Using the stopwatch timer:

When this function is ON, press $\boxed{=}$ key to start counting; Press $\boxed{=}$ key again to re-start counting.

To exit the function, stop the counting first, and then press the $\boxed{\text{OFF}}$ key.



6.8 DTMF







DTMF is an in-band signaling method using dual sinusoidal signals for any given code. Originally developed for telephony systems, it has proved a very versatile tool in many other areas.

In two-way radio systems, DTMF is most commonly used for automation systems and remote control. A common example would be in amateur radio repeaters where some repeaters are activated by sending out a DTMF sequence (usually a simple single-digit sequence).

DTMF frequencies and corresponding codes

	1209Hz	1336Hz	1477Hz	1633Hz
697Hz	1	2	3	A
770Hz	4	5	6	B
852Hz	7	8	9	C
941Hz	*	0	#	D

The radios have a full implementation of DTMF, including the A, B, C and D codes.

The numerical keys, as well as the , and , keys correspond to the matching DTMF codes as you would expect. The A, B, C and D codes are located in the , ,  and  keys respectively.

To send DTMF codes, press the key(s) corresponding to the message you want to send while holding down the PTT key.





If you have the keypad lock enabled on your radio, you can still send DTMF tones the regular way without having to unlock your radio.

6.9 Customization

The radio allows you to define visual and audible features such as Display Illumination Time, MR/Channel Mode Display Format, Power On Message, Power On password, Keypad Beep, Roger Beep, Voice Prompt, etc. to suit your usage habits.

6.9.1 Display backlight (ABR) - MENU 7

In standby mode, press  + 7. The screen will display “ABR”.

Press  key to enter the function. Press the  /  keys to select the always-on/required delay time (ON/5sec/5sec/10sec/15sec/20sec) the backlight of the display, then press  key to confirm.

To return to the standby mode press  key.

6.9.2 Beep PROMPT (BEEP) - MENU 8

If you enable this function, every time a key is pressed, you will hear a Beep tone.



In standby mode, press  + 8. The screen will display “BEEP PROMPT”.

Press  key to enter the function. Press the  /  keys to turn ON/OFF the beep function.

Press  key to confirm and exit to return to standby mode.

6.9.3 Voice function (VOICE) - MENU 17

In standby mode, press  + 17; the screen will display “VOICE”.

Press  key to enter the function. Press the  /  keys to select OFF/ON. Confirm your selection by pressing MENU.

To return to the standby mode press  key.

6.9.4 Language of the MENU (LANGUAGE) - MENU 18

This section shows the language of the MENU (English).

In standby mode press $\boxed{\text{F}} + 18$. The display will show "LANGUAGE".

6.9.5 Working Mode (MDF-A) - MENU 24

The radio has four working modes available:

- Frequency mode (FREQ)
- Channel mode (CH)
- Channel name (NAME)

To shift from one mode to another one:

In Standby mode press $\boxed{\text{F}} + 24$; select the desired working mode with the $\blacktriangle/\blacktriangledown$ keys.

Press $\boxed{\text{F}}$ key again to confirm your selection.

6.9.6 Roger Beep, end Transmission Tone (ROGER) - MENU 36

Roger Beep can be enabled/disabled:

- OFF: Roger Beep disabled
- ON: Roger Beep tone at the end of transmission

In standby mode, press $\boxed{\text{F}} + 36$; the screen will display "ROGER".

Press $\boxed{\text{F}}$ to enter the function. Press the $\blacktriangle/\blacktriangledown$ keys to select OFF/ON. Confirm your selection by pressing $\boxed{\text{F}}$ key.

To return to the standby mode press $\boxed{\text{M}}$ key.

6.9.7 Power On Message (POWER ON MSG) - MENU 40

With this Menu you can customize the welcome message that appears on the display when the radio is switched on.

Choose amongst the following options:

- VOLTAGE (the power voltage is momentarily displayed)
- MESSAGE (welcome message)
- LOGO (Custom Pictures)
- MODEL NAME (the model name of the radio will be displayed)

In Standby mode press $\boxed{\text{F}} + 40$. The display will show "POWER ON MSG".



Press $\boxed{\text{F}}$ key to enter the function. Press the $\blacktriangle/\blacktriangledown$ keys to select the desired option and confirm with MENU.

To return to the standby mode, press  key.

6.9.8 Power On Password (Power On Password) - Menu 43

With this Menu you can request the correct password when the radio is turned on.

In standby mode, press MENU + 43. The display will show "POWER ON PWD"

Press  key to enter the function. Press the  /  keys to enable/disable (ON/OFF) the power on password and confirm with MENU.

To return to standby mode, press  key.

Enable the power-on password function. Each time the radio is turned on, it will display "Input Password" to prompt for the correct password.

6.10 Reset - MENU 42

This transceiver has two Reset modes available: VFO and ALL.

- Reset VFO: all the settings except channels will return to the default settings.
- Reset ALL: all settings will return to the default settings.

Reset VFO





In standby mode, press  + 42; the screen will display "RESET".

Press  to enter the function. Press the  /  keys to select VFO, then press  to confirm.

The display will show "Sure to reset? ". Press  again to confirm and the screen will display "Wait...". Then, the transceiver will turn off and reboot again.

Reset ALL

In standby mode, press  + 42. The screen displays "RESET".

Press  to enter the function. Press the  /  keys to select ALL, then press  to confirm.

The display will show "Sure to reset? ". Press  again to confirm; the screen will display "Wait...". Then, the transceiver will turn off and reboot again.

Appendix A. – Troubleshooting guide

Phenomena	Analysis	Solution
You cannot turn on the radio.	The battery may be installed improperly.	Remove and reattach the battery.
	The battery power may run out.	Recharge or replace the battery.
	The battery may suffer from poor contact caused by dirty or damaged battery contacts.	Clean the battery contacts or replace the battery.
During receiving, the voice is weak or intermittent.	The battery voltage maybe low.	Recharge or replace the battery.
	The volume level may be low.	Increase the volume.
	The antenna maybe loose or maybe installed incorrectly.	Turnoff the radio, and then remove and reattach the antenna.
	The speaker maybe blocked.	Clean the surface of the speaker.
You cannot communicate with other group members.	The frequency or signaling type maybe inconsistent with that of other members.	Verify that your TX/RX frequency and signaling type are correct.
	You may be too far away from other members.	Move towards other members.
You hear unknown voices or noise.	You may be interrupted by radios using the same frequency.	Change the frequency, or adjust the squelch level.
	The radio in analog mode maybe set with no signaling.	Request your dealer to set signaling for the current channel to avoid interference
You are unable to hear anyone because of too much noise and hiss.	You may be too far away from other members.	Move towards other members.
	You may be in an unfavorable position. For example, your communication may be blocked by high buildings or blocked in an underground area.	Move to an open and flat area, restart the radio, and try again.
	It may be the result of external disturbance (such as electromagnetic interference).	Stay away from equipment that may cause interference.
The radio keeps transmitting.	VOX may be turned on or the headset is not installed in place	Turn off the VOX function. Check that the headphones are in place.

NOTE: *If the above solutions cannot fix your problems, or you may have some other queries, please contact your dealer for more technical support.*

Appendix B. - Shortcut Menu operations

MENU	Name (Full Name)	Settings	Description
0	SQL - Squelch Level	SQL: 0-5 step:1 Setting the squelch to 0 will open up the squelch entirely.	Squelch silences the receiver when there is no signal. - Sensitivity can be varied from .1 to .3 mV on UHF Sensitivity can be varied from .1 to .2 mV on VHF
1	STEP - Step Frequency	2.5K[0] 5.0K[1] 6.25K[2] 10.0K[3] 12.5K[4] 20.0K[5] 25.0K[6] 50.0K[7]	Selects the amount of frequency change in VFO/Frequency mode when scanning or pressing the ▲/▼ keys.
2	TXP - Transmit Power	HIGH [0] LOW [1]	Selects between HIGH and LOW transmitter power when in VFO/Frequency mode. Use the minimum transmitter power necessary to carry out the desired communications.
3	SAVE - Battery Save	Save: OFF、 1:1、 1:2、 1:4	Selects the ratio of sleep cycles to awake cycles (1:1, 2:1, 3:1, 4:1). The higher the number the longer the battery lasts. The higher number increases the RX sleep cycle, but you may miss the first few syllables before the RX opens.
4	VOX - Voice Operated TX	VOX: 1-9 step:1	When enabled it is not necessary to press the [PTT] key on the transceiver. Adjust the gain level to an appropriate sensitivity to allow smooth transmission.
5	WN - Wideband / Narrowband	WIDE [0] NARR [1]	Wideband (25 kHz bandwidth) or narrowband (12.5 kHz bandwidth).
6	ABR - Display Illumination Time	ABR: 5-20S,step:5s	Time-out for the LCD backlight. (seconds)
7	TDR - Dual Watch, Dual Reception	OFF [0] ON [1]	Monitor [A] and [B] at the same time. The display with the most recent activity ([A] or [B]) becomes the selected display

8	BEEP - Keypad Beep	OFF [0] ON [1]	Allows audible confirmation of a key press
9	TOT- Transmission Time-out-Timer	OFF [0] 15[1] - 180[12] in 15 second steps (TIMEOUT-15)/15=[n]	*This feature provides a safety switch that limits transmission time to a programmed value. This will promote battery conservation by not allowing you to make excessively long transmissions, and in the event of a stuck PTT switch it can prevent interference to other users as well as battery depletion
10	R-CTCS - Receiver CTCSS	OFF [0] see CTCSS Table in Appendix C	Mutes the speaker of the transceiver in the absence of a specific and continuous sub-audible signal. If the station you are listening to does not transmit this specific and continuous signal, you will not hear anything.
11	R-DCS - Receiver DCS	OFF [0] see DCS Table in Appendix C	Mutes the speaker of the transceiver in the absence of a specific low-level digital signal. If the station you are listening to does not transmit this specific signal, you will not hear anything.
12	T-CTCS - Transmitter CTCSS	OFF [0] see CTCSS Table in Appendix C	Transmits a specific and continuous sub audible signal to unlock the squelch of a distant receiver (usually a repeater).
13	T-DCS -Transmitter DCS	OFF [0] see DCS Table in Appendix C	Transmits a specific low-level digital signal to unlock the squelch of a distant receiver (usually a repeater).
14	Scan CTCSS	OFF	Allows scanning of CTCSS in VFO frequency mode. This operation is not allowed in channel mode.
15	Scan DCS	OFF	Allows scanning of DCS in VFO frequency mode. This operation is not allowed in channel mode.
16	CDCSS SAVE MODE	ALL[0] RX[1] TX[2]	Save the scanned CTCSS/DCS in VFO mode. <ul style="list-style-type: none"> •ALL: Save to R-CDCSS and T-CDCSS •TX: Save to T-CDCSS only •RX: Save to R-CDCSS only

17	VOICE - Voice Prompt	OFF [0] ON [1]	Allows audible voice confirmation of a key press
18	LANGUAGE - Language selection	ENGLISH [0] 中文 [1]	Set the language type of menu and prompt voice. •ENGLISH: Display as an English menu with English prompts for operation. •Chinese: Display as a Chinese menu and prompt for operation in Chinese.
19	DTMFST - DTMFST	<ul style="list-style-type: none"> •OFF [0]: No DTMF Side Tones are heard •DT-ST [1]: Side Tones are heard only from manually keyed DTMF codes •ANI-ST [2]: Side Tones are heard only from automatically keyed DTMF codes •DT+ANI [3]: All DTMF Side Tones are heard 	Determines when DTMF Side Tones can be heard from the transceiver speaker.
20	S-CODE - Signal Code	1[0] 2[1] 3[2] 4[3] 5[4] 6[5] 7[6] 8[9] 9[8] 10[9] 11[10] 12[11] 13[12] 14[13] 15[14]	Selects 1 of 15 DTMF codes. The DTMF codes are programmed with software and are up to 5 digits each.
21	SC-REV - Scanner Resume Method	<ul style="list-style-type: none"> •TO [0]: Time Operation - scanning will resume after a fixed time has passed •CO [1]: Carrier Operation - scanning will resume after the signal disappears •SE [2]: Search Operation - scanning will not resume 	Scanning Resume Method
22	PTT-ID - When to send the PTT-ID	<ul style="list-style-type: none"> •OFF [0]: No ID is sent •BOT [1]: The selected S-CODE is sent at the beginning •EOT [2]: The selected S-CODE is sent at the ending •BOTH [3]: The selected S-CODE is sent at the beginning and ending 	When to Send PTT-ID Codes are sent during either the beginning or ending of a transmission.
23	PTT-LT - Signal code sending delay	0[0] 100[1] 200[2] 400[3] 600[4] 800[5] 1000[6]	PTT-ID Delay (milliseconds)

24	MDF-A - Channel Mode A Display	<ul style="list-style-type: none"> •CH [0]: Displays the channel number •NAME [1]: Displays the channel name. •FREQ [2]: Displays programmed Frequency 	[A] MR/Channel Mode Display Format Note: Names must be entered using software.
25	MDF-B - Channel Mode B Display	<ul style="list-style-type: none"> •CH [0]: Displays the channel number •NAME [1]: Displays the channel name. •FREQ [2]: Displays programmed Frequency 	[B] MR/Channel Mode Display Format Note: Names must be entered using software.
26	BCL - Busy Channel Lock-out	OFF [0] ON [1]	Disables the [PTT] key on a channel that is already in use. The transceiver will sound a beep tone and will not transmit if the [PTT] key is pressed when a channel is already in use.
27	AUTOLK – Automatic Keypad Lock	AUTOLK: OFF ON	Set the automatic keyboard lock delay time. To prevent the keyboard from being accidentally triggered. When turned on, if the keyboard is not used within a predetermined delay time, the keyboard will be locked. Pressing the  key for 2 seconds will unlock the keypad.
28	SFT-D - Frequency Shift Direction	<ul style="list-style-type: none"> •OFF [0]: TX = RX (simplex) •+ [1]: TX will be shifted higher in frequency than RX •- [2]: TX will be shifted lower in frequency than RX 	Enables access of repeaters in VFO/Frequency Mode
29	OFFSET - Frequency shift amount	00.000 - 69.990 in 10 kHz steps	Specifies the difference between the TX and RX frequencies
30	MEMCH - Store a Memory Channel	001 - 999	This menu is used to either create new or modify existing channels (001 through 999) so that they can be accessed from MR/Channel Mode.
31	DELCH - Delete a memory channel	001 - 999	This menu is used to delete the programmed information from the specified channel (001 through 999) so that it can either be programmed again or be left empty.

32	AL-MOD - Alarm Mode	<ul style="list-style-type: none"> •SITE [0]: Sounds alarm through your radio speaker only •TONE[1]: Transmits a cycling tone over-the-air •CODE [2]: Transmits '119' (911 in reverse) followed by the ANI code over-the-air 	<ul style="list-style-type: none"> •SITE: Sounds alarm through your radio speaker only •TONE: Transmits a cycling tone over-the air •CODE: Transmits '119' (911 in reverse?) followed by the ANI code over-the-air
33	STE - Squelch Tail Elimination	OFF [0] ON [1]	This function is used eliminate squelch tail noise between BaoFeng handhelds that are communicating directly (no repeater). Reception of a 55 Hz or 134.4 Hz tone burst mutes the audio long enough to prevent hearing any squelch tail noise.
34	RP-STE - Squelch Tail Elimination	OFF [0] 1 - 10	This function is used eliminate squelch tail noise when communicating through a repeater.
35	RPT-RL - Delay the squelch tail of repeater	OFF [0] 1 - 10	Delay the Tail Tone of Repeater (X100 milliseconds)
36	ROGER - Roger Beep	OFF [0] ON [1]	Sends an end-of-transmission tone to indicate to other stations that the transmission has ended.
37	TONE-Tone-burst	1000[0] 1450[1] 1750[2] 2100[3]	To send out a tone-burst; you simultaneously will press a key while holding down the PTT. No further configuration required using this feature.
38	MENU EXIT TIME	5 [0] 10[1] - 60[10] in 5 second steps (TIMEOUT-5)/5=[n]	The time setting for menu exit without menu operation.
39	VOX DELAY	0.5 [0] 0.6[1] - 2.0[15] in 0.1 second steps (TIMEOUT-0.1)/0.1=[n]	There's a brief delay between when you finish talking and the radio returns to tx mode; this delay can be adjusted.
40	POWER ON MSG - Power On Message	LOGO[0] VOLTAGE[1]	Welcome message displayed immediately after startup. The LOGO is programmed by the manager.
41	voice encryption	OFF [0] ON [1]	Activate the frequency hopping function to prevent interference from outside the group
42	RESET - Restore defaults	VFO [0] ALL [1]	Resets the radio to factory defaults, with some exceptions.

43	POWER ON PWD -Power on password	OFF [0] ON [1]	Activate the radio power-on password. You must enter the correct password to turn on the radio
44	STOP WATCH	ON	Activate the stopwatch function. Press the MENU key to start timing.
45	VERSION - Version information		Access hardware and firmware information for the radio

Appendix C. - Technical Specifications

General

Frequency Range	TX:144-148M、420M-450M; RX: 136-174M、400-519.995M FM: 65M-108M
Power	5W/2W
Channel Spacing	25.0KHz(Wide)/12.5KHz(Narr)
Memory Channel	999 Groups
Operation Voltage	DC 7.4 V \pm 10%
Transmission current	\leq 1700mA
Receive Sensitivity	0.25 μ V (12dB SINAD)
Rated Audio Power Output	1W @16 ohms
Receive current	\leq 380mA
Connection for accessories	2 pin Kenwood jack
Antenna impedance	50 Ohm

NOTE: All specifications may be modified without prior notice or liability. Thank you.

Disclaimer

The Company endeavors to achieve the accuracy and completeness of this manual, but no warranty of accuracy or reliability is given. All the specifications and designs are subject to change without notice due to continuous technological development. No part of this manual may be copied, modified, translated, or distributed in any manner without the prior written consent of the Company.

We do not guarantee, for any particular purpose, the accuracy, validity, timeliness, legitimacy or completeness of the third-party products and contents involved in this manual.



Thank You for Shopping at Radioddity!

FIND TUTORIALS, SUPPORT AND MORE



<https://www.radioddity.com/>



<https://www.facebook.com/radioddity>



<https://www.youtube.com/c/Radioddityradio>