

To customers

Thank you very much for using our two-way radios. This product has a newly developed function menu and humanism operation design, making it easy to use. It will meet your requirement by the compact size and reasonable price.

Welcome to use our two-way radio

Professional FM Transceiver

Frequency band:

VHF:136-174MHz

UHF:400-480MHz

1000 channels

Remote kill/stun/activate

Voice prompt

Power-on protection

Color LCD display

Text messages in digital mode

Encryption function

Built-in CTCSS/DCS

Up to 1000 channels

Priority scan

Complying with digital protocol ETSI TS 102 361-1, -2, -3

Compatible with Mototrbo Tier I & II

DTMF decoding and encoding

Updated software available for new features

Private call, group call, all call in digital mode.

Operate in both Digital & Analogue mode,
allows easily migrate from analog to digital.

Provide clearer voice communications in
digital mode, throughout the coverage area.

IP67 waterproofed function

GPS optional

Professional FM Transceiver



CONTENTS

Using Tips,Unpacking And Checking equipments -----	01
Getting Familiar -----	12
Safety and Overview -----	14
Overview -----	15
Switch On -----	15
Adjust Volume -----	15
Launch And Receive Calls -----	17
Zone Selection-----	17
Selection of Channels ,User ID Or Group ID -----	17
Receive And Reply Group Call -----	17
Receive And Reply The Single Call -----	18
Receive All Calls -----	19
Launch A Radio Call -----	19
Using Channel Knob To Make A Call -----	20
Group Call -----	20
Single Call -----	20
All Call-----	21
Use A Key To Make A Group Call Or Single Call -----	21
Emergency Function -----	23
Receive Emergency Call -----	23
Reply The Emergency Call -----	24

Emergency Alarm -----	25
Emergency Alarm Call -----	25
Voice Emergency Alarm -----	26
Re-start Emergency Mode -----	27
Logout Emergency Mode-----	28
Menu Operation -----	30
Character Input -----	30
English Typing-----	30
Chinese Typing -----	31
Numeral Writing -----	31
Menu Application -----	32
Radio Check -----	32
Send Radio Check -----	32
Monitor -----	33
Start Monitor -----	33
Contacts Setting -----	34
Group Call With Contacts -----	35
Single Call With Contacts -----	36
Call Log -----	37
Checking New Call's Number -----	37
Missed Call -----	37
Storing Missed Call's Alias Or ID -----	38
Deleting Call Log's Record -----	38
Call Alert Operetion -----	39

Receiving And Checking Call Alert	39
Starting Call Alert From Contacts List	40
Message Function	40
Edit And Send SMS	40
Send Quick Text	41
Send Quick Text With A Key	43
Manage The Failed SMS	43
Manage The Sent SMS	46
Receive SMS	48
Check the SMS	49
Manage Received SMS	49
Check The Inbox SMS	50
Reply The Inbox SMS	50
Deleting The Inbox Messages	52
Deleting All Messages In The Inbox	52
Encryption	53
Basic Encryption	53
DTMF	53
Secrecy	54
Radio Disable	54
Radio Enable	55
Scraning List	56
Check Members of List	56
Scaning Instruction	56

Start/Stop Scan	57
Scaning Reply	58
Utilities	59
Radio Settings	59
Talkaround	60
Tones/Alerts	60
All Tones	61
Talk Permit	61
Keypad Tones	61
Power	62
Backlight	63
Squelch	63
Intro Screen	64
Keypad Lock	64
Language	65
LED Indicator	66
VOX	66
Passwd Lock	68
Clock	69
Time	69
Date	70
Mode	70
Radio Info	71

My Number	71
Versions	71
Program Radio	72
Rx Frequency	72
Tx Frequency	73
Channel Name	74
Time out Timer (TOT)	75
CTC/DCS	75
Encode	75
Decode	76
Color Code	77
Repeater Slot	77

Using tips

Unpacking and checking equipments

Using tips

Please read the following brief instructions, non-compliance with these rules may cause danger or violate the law.

- Obey the local government regulation before using this radio, improper use may violate the law and be punished.
- Turn off the radio before entering flammable or explosive areas.
- Do not charge or change the battery in flammable or explosive areas.
- Turn off the radio before getting close to the blasting zone or detonator areas.
- Do not use radio whose antenna is damaged, touching of damaged antenna will cause heat injury.
- Do not attempt to open the radio; the maintenance work should be done by technical expert only.
- To avoid troubles caused by electromagnetic interference or electromagnetic compatibility, please turn off the radio in places where have the banner "Do not use wireless equipment", such as hospital and other healthcare places.
- In the car with an airbag, do not put the radio within the scope of the airbag deployment.
- Do not store the radio under the direct sunshine or in hot areas.
- When you transmit with the radio, do keep away from its antenna for 5cm at least.
- If the radio appears smelly or smoke, please shut off its power immediately and contact with your local dealer.
- Do not transmit too long, for the radio may heat and hurt the user.

Unpacking and checking equipments

Carefully unpack the radio. We recommend you check the items listed in the following table before discarding the package. If any item is missing or has been damaged during shipment, please contact us immediately.

Supplied accessories:

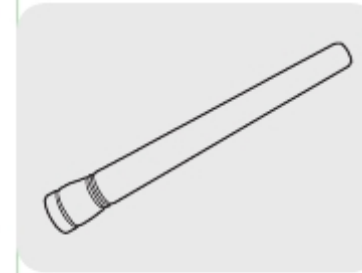

Antenna (1)



Li-ion battery (1)



Belt Clip (1)

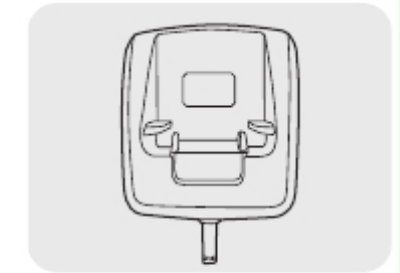

Charger (1)



Verification (1)



User's Manual (1)

Note: The antenna frequency range please refers to the annular label at the bottom of antenna.

Battery Antenna

Installing and Uninstalling of supplied accessories

Professional FM Transceiver

Battery

- Notice:**
1. Please do not short-circuit the battery terminals or expose of in fire. Do not disassemble the battery by yourself.
 2. Charge the battery between temperature 0°C and 45°C. The battery can not be fully charged beyond this temperature range.
 3. Please turn off the power when you charge the radio with battery. Transmit with the radio in charge will affect its correct charge.
 4. Do not unplug the power or battery when it is charged.
 5. The operating time becomes short even the battery is fully charged, the battery is exhausted, please replace battery.
 6. Please do not charge when the battery or the radio is wet. Please dry it with a cloth before charging to avoid any danger.

Warning: When the conductive metals such as jewelery, key or decorative chains touch the battery terminals, all the batteries are likely to cause damage to the items or personal injury. These conductive metals may form a short circuit and generates much heat. Do deal with any battery carefully, especially when put it into pocket, wallet or other metallic containers.

Charging operations:

Charge the battery as follows:

- 1) Power off
- 2) Insert the DC adaptor plug in the DC jack on the back of charger
- 3) Insert the AC adaptor plug in the AC power output socket
- 4) Insert the battery or radio with battery vertically in a charger, to check whether the battery and charger terminal is in normal contact.
- 5) Make sure the battery and charger terminal is in good contact, when the charging indicator light turns red, it starts charging.

Note: 1. Before inserting the battery, it is abnormal if the charging indicator blinks
2. To change the battery for charging, please wait until the indicator is stable.
3. When the battery is well inserted, the indicator turns red and the charging is on the process, if the indicator blinks, then the battery is damaged or the temperature is too high or too low.

Self-testing

When the charger powers up, if the orange indicator lights for one second and then goes out, entering the standby mode, the charger passes the self-testing and can charge the battery. If the orange indicator blinks constantly, the charger fails to pass the self-testing, and can not charge the battery.

Normal charging indicator

When charging the battery, if the indicator light turns red, the battery is on the normal charge; if the red indicator light blinks constantly, the battery capacity is too low, and is on the trickling charge, and after the battery capacity reaches a certain level, it will switch to the normal charge.

Note: Trickle charge does not exceed 30 minutes, if the red indicator light blinks after 30 minutes, it means the charger can not charge battery, please check whether the battery or the charger has been damaged.

Charging precautions:

- 1) The battery is not fully charged in factory, please charge before using it.
- 2) Charge and discharge the battery for two or three times, the battery capacity will reach the best condition. When the battery capacity is low, please charge or change the battery.
- 3) The battery lasts shortly even if it is fully charged, the battery is exhausted, please contact your local dealer to buy a new authentic battery.

Antenna

- Short thick antenna is suitable for short-distance communication, while long thin antenna will offer you a better communication effect. Wearing the radio in your waist will not make you feel uncomfortable.
- The communication range will be shortened in bad weather or among the trees, please prepare in advance to avoid any inconvenience of your communication and security.

Installing and uninstalling of the accessories

Installing/Removing the battery

- 1) Align the two grooves of battery and the guide rail on the back of aluminum shell, ensuring full contact and in parallel, then push the battery up to the radio base along the rail on the back of aluminum shell, until the battery latch locks up. (picture 1)
- 2) To remove the battery, please make sure the radio is closed, push the battery latch down, and make sure the radio and battery is on the releasing state, and then push the battery out from the radio. (picture 2)

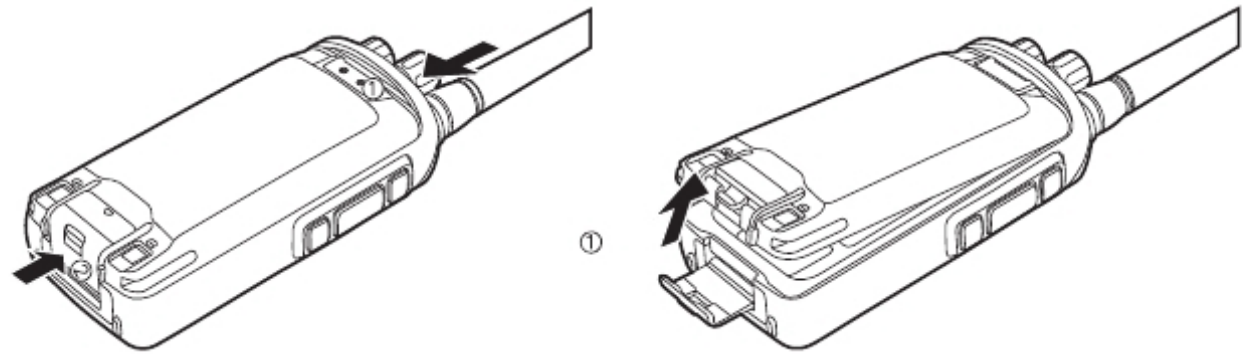

Installing and removing the antenna

- 1) Align the threaded end of antenna and the threaded hole at the top of radio, rotate the antenna clockwise until it is tight. (picture 3)
- 2) To remove the antenna, rotate it counter-clockwise until the antenna spirals out. (picture 4)

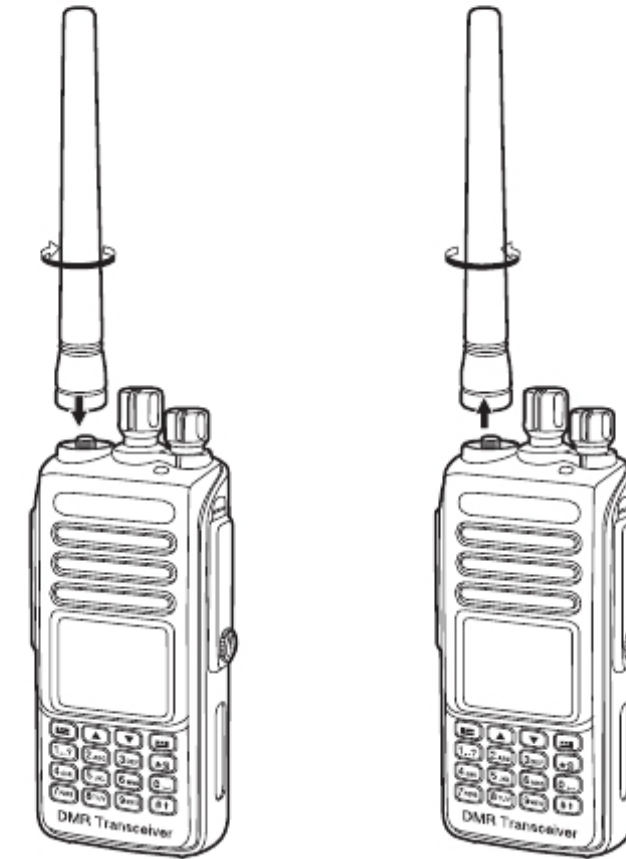

Installing/removing the belt clip

- 1) Align the two holes of belt clip and the two holes of the radio, fix them with the supplied M2.5x5 screw. (picture 5)
- 2) Loosen the screw set to remove the belt clip (picture 6)

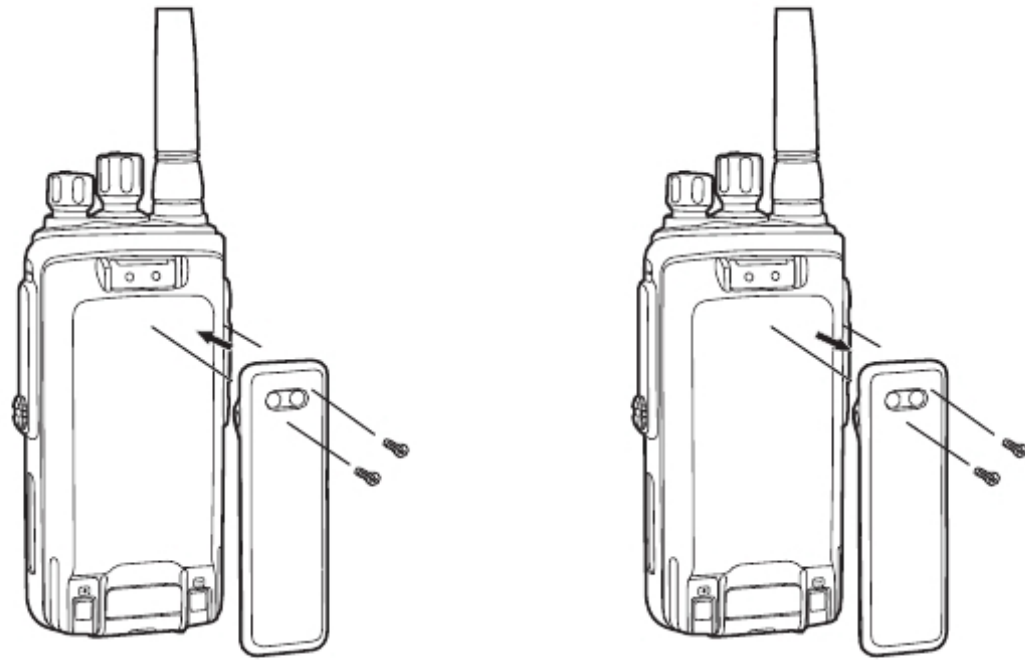

Installing external headset

Reveal (do not remove) the mic/speaker jack cover (picture 7), insert the headset into the mic/speaker jack (picture 8).

Note: Using the external headset will affect the water-tightness performance of radio.

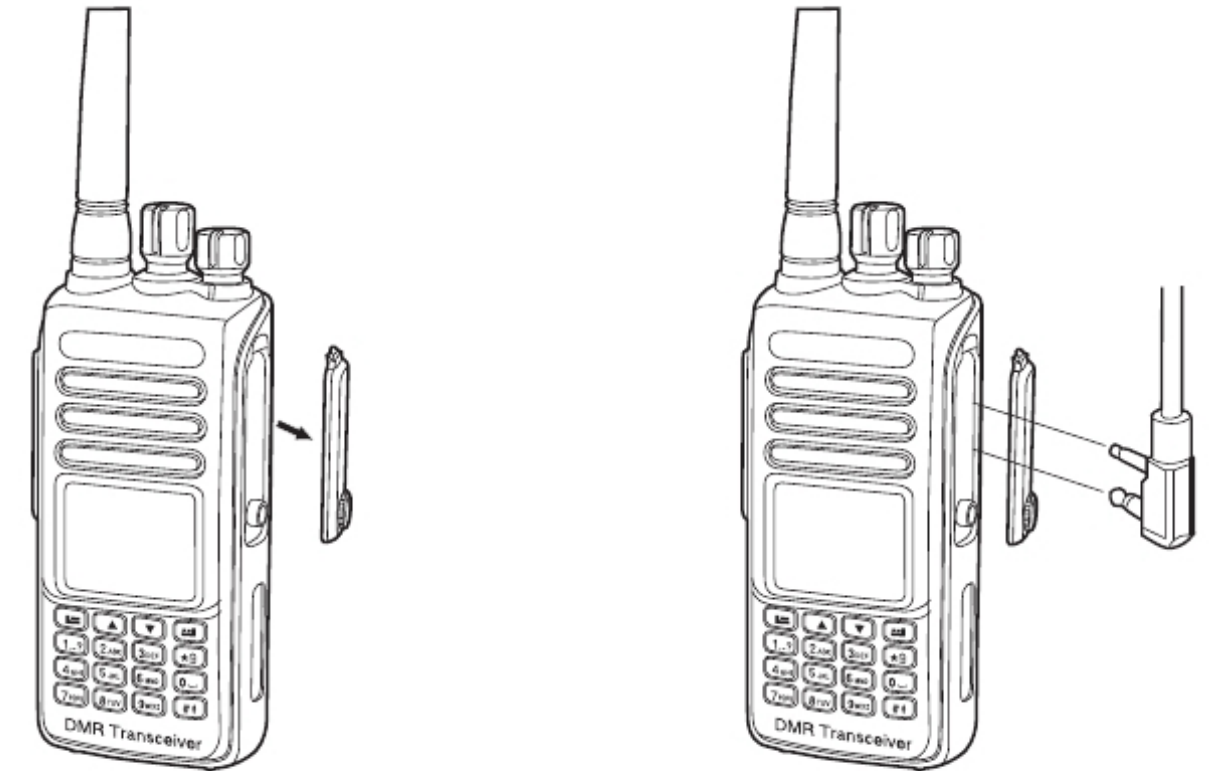

Getting familiar

Safety and Overview

Overview

Professional FM Transceiver

Getting familiar

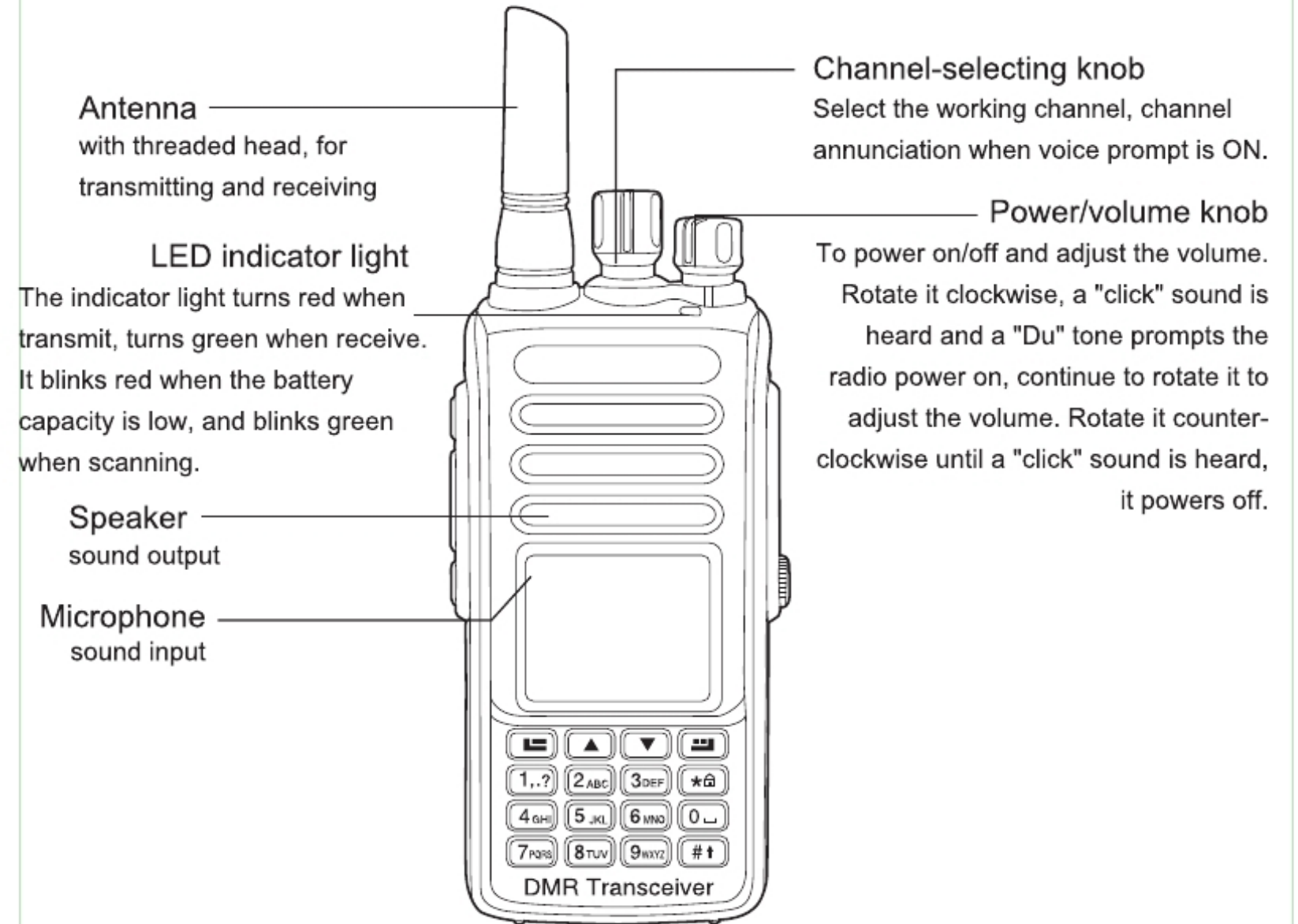

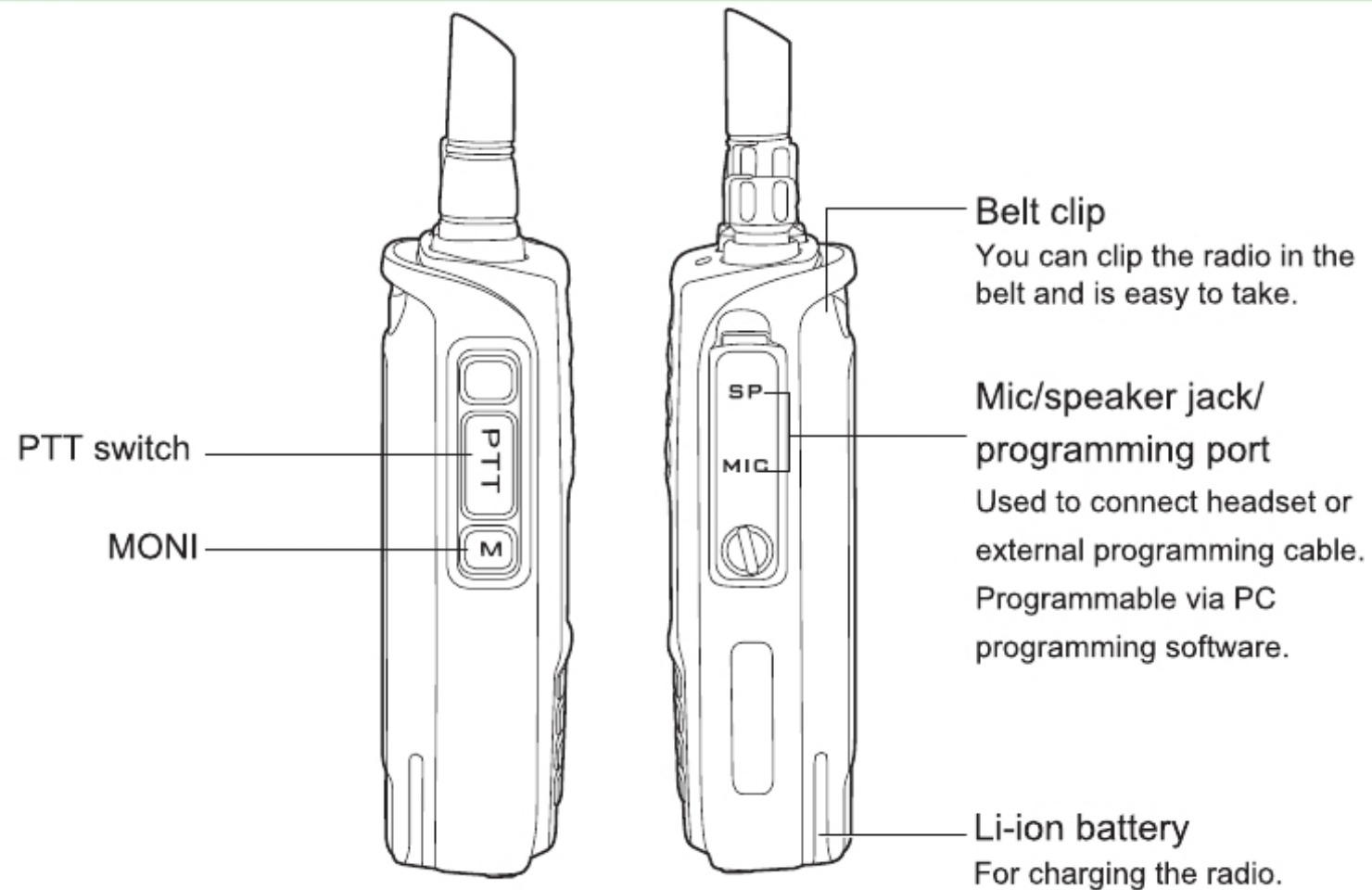

Notice: Either Long-press or Short-press of Side-key 1/ Side-key 2/ Side-key 3 can be set by program software for the following functions : 1.None-function 2.All warning tone on/off 3.High/Low power 4.Monitor 5.PTT 1 6. PTT 2 7. PTT 3 8. PTT 4 9. PTT 5 10. PTT 6 11.Repeater/Talkaround 12.Scan on/off 13.Tight/Normal SQL 14.Encryption on/off 15.VOX on/off 16.Zone off 17.Battery indicator 18.Work alone on/off 19.REC switcher(Depends on the hardware) 20.Recode voice review(Depends on the hardware) 21. Delect all recode voice (Depends on the hardware)

Safety and Overview

Product safety and RF Exposure for handheld two way radio .



Before using this two way radio ,please read the manual which contains important operating instructions for safe usage,RF Energy Awareness, control information and operational instructions for compliance with RF Energy Exposure limits in applicable national and international standards Also read the operational instructions for safe use.

Overview

Switch On

Clockwise to turn on the radio volume knob, there will be a "KADA" sound , message sound , while the LED indicator lights up and becomes Green color if the battery is full charged.

Notice: if all LED indicators are forbidden, the screen will not light up when switch on the walkie talkie, but with a message sound .

Notice: if the Tones/Alerts is forbidden ,there will not any sound when power on . Here, need to power off the walkie talkie and anticlockwise with the knob until a "KADA" sound .

Adjust Volume

Clockwise the volume knob to higher the volume or anticlockwise to lower: And there shows a volume line on the screen

Launch And Receive Calls Emergency Function







Professional FM Transceiver

Launch And Receive Calls

Zone Selection

Zones is a channel group.Each radio can set 250 zones and each zone with max 16 channels

The menu function:

1. Press [] key to enter the menu.
2. Press [ or ] key to choose,after that with [] key to confirm.
3. Screen shows the chosen zone and named by it .
4. Press [ or ] key to chose,after that press [] key to confirm.
5. Screen shows the chosen zone and named by it.

Selection Of Channels , User ID Or Group ID

Select the needed zone (if there are more than one zone),using the channel knob to select the channel ,user name or ID,group name or ID.

Receive And Reply Group Call

The radio must be under a group , then can receive the group call .

When received the group call:

1. LED indicator is green color.
2. On the top of the middle screen will show RSSI mark:First line will show the group name, income call ID will be in the middle ,group call ICON will be the last (this happens only under Digital mode)

3. Hold the radio and place it between your lip within 2.5~3cm

4. Press[PTT]key to answer the call,LED indicator light change to red color.

5. Release[PTT]key to receive next call

6. If there are not any voice activity, the call end.

Notice: When the radio out of the home page and if there is a group call income , it will be show all the time on the screen before you answer it .

Press [] key to receive the call ,and check the income ID before reply.

Receive And Reply The Single Call

Single call means one on one call. Only with two types: One is testing presence of radio before call, and another one is to call immediately.

When Receive The Single Call:

1. LED indicator is green color.
 2. On the top of the middle screen will show RSSI mark, follows shows single call, user name or ID in the middle,single call mark at the end (Only for analogue mode).
 3. Hold the radio and place it between your lip with 2.5~3cm
- If on the "free channel message sound" function,let go [PTT] key, you can hear a message sound,means this channel is free for you to answer .
4. Press[PTT]key to answer the call,LED indicator light change to red color.
 5. Release [PTT]key to receive .
 6. If there are not any voice activity, the call end.
 - 7.You will hear a message sound and screen shows the call finished .

Receive all calls

All call means a walkie talkie call up all other users in a channel to public an important information

When receive the all calls:

1. LED indicator becomes green.
2. On the top of the middle screen will show RSSI mark, follows shows all call, User name or ID in the middle, all call mark at the end (Only for digital mode)
3. End of the all call, radio back to the screen before all call. If under the "free channel message sound" function, when release the PTT key, you will hear a message sound, means this channel is free to use and cannot reply

Notice: when receive the all call, if you turn over to another channel, the radio stop to receive all call. During the all call, You cannot use any re-programmed key until the call finished.

Launch a radio call

You can choose a channel , user ID or group call with following methods

- Channel Knob
- Pre-programmed key
- Contacts
- Manual dialing (only for single call)

Using Channel Knob To Make A Call

Group Call

The radio should be under the group then can have the group call

1. Turn over channel knob , use group name or ID to choose channel
2. Hold the radio and place it between your lip with 2.5~3cm.
3. Press [PTT] key to call, LED indicator changes to red. Screen shows group name or ID with group mark.
4. Let go [PTT] key to receive, when target radio is replying, LED indicator becomes green. Screen shows group mark or name or ID .
5. If on the "free channel message sound" function. let go [PTT] key, you can hear a message sound, means it channel is free for you to answer.

If there are not any transmitter within the time limited , the call failed.

6. when walkie talkie back to home screen ,you can make a group call with contacts.

Single Call

1. Turn over channel knob , use the name or user ID to choose channel.
2. Hold the radio and place it between your lip with 2.5~3cm.
3. On the top of the middle screen will show RSSI mark, follows shows single call. User name or ID in the middle, single call mark at the end (Only for analogue mode).
4. Let go [PTT] key to receive, when target radio is replying, LED indicator becomes green
5. If on the "free channel message sound" function, let go [PTT] key, you can hear a message sound (means it channel is free for you to answer)

If there are not any transmitter within the time limited , the call failed .

6. you will receive a message sound and screen shows call finished .

You can make a single call with contacts or use keyboard to search the target walkie talkie to make a call.

All Call

Walkie talkie must be programmed with this function , so that you can send information to every user who are under the channel .

1. Turn over channel knob , use the name or user ID to choose channel.
2. Hold the radio and place it between your lip with 2.5~3cm.
3. Press [PTT] key to release a call , LED indicator becomes to red color .Screen shows Group name or ID with all call mark .

User under the channel can not reply the call .

Use A Key To Make A Group Call Or Single Call

Single key call function is convenient for you to set a name or ID for group call or single call with long-press or short-press the program key. Set a name or ID for a key there are more than one single call key

1. Press pre-programmed call key.
2. Hold the radio and place it between your lip with 2.5~3cm
3. Press [PTT] key to call , LED indicator becomes to red color .Screen shows name or ID with a mark .

4. Let go[PTT] key to receive, when target walkie talkie is replying ,LED indicator changes to green .

5. If on the "free channel message sound" function , let go [PTT] key,you can hear a message sound, means it channel is free for you to answer .

If there are not any voice activity, the call end.

6. Walkie talkie back to before call screen.

Emergency Function

Emergency alarm only use to transfer emergency situations, you can release a emergency call at anytime and anywhere . Even the walkie talkie is busy in transferring or receiving

Radio support 3 types of emergency call:

- Emergency Call
- Call follow emergency alarm
- A voice follow emergency alert

Moreover: alarm has the following types:

- Prohibit: radio can not send emergency call but can receive .
- Local + Remote: An emergency call with voice or notice .
- Remote: an emergency call without any voice or notice. Before press [PTT]key to call , local radios will not receive any voice or notice .
- Remote + Voice : radio sending an emergency call while accept to receive calls. Before press the [PTT] key to transmitter or reply , there are not any notice

Only one part of above emergency situations can be set as pre-programmed key.

Receive Emergency Call

1. When receiving emergency call, number of emergency calls and alarms received ,exchange the sender name or ID .
2. With a message sound and LED indicator becomes red
3. If the radio have activated, then will confirm the emergency alarm automatically .When

the radio receive the emergency alarm, screen shows the emergency alarm warning mark, until send with a confirm message then can logout . While , you will not receive any calls and notices from other radios during this situation .

Notice:short-press [] key, then with the pre-programmed off key, delect all received emergency call and logout the emergency mode .

Reply the emergency call

When received the emergency call:

1. Press any key to stop the emergency call alarm
2. Hold the radio and place it between your lip with 2.5~3cm . If on the "free channel message sound" function, let go [PTT] key, you can hear a message sound, means it channel is free for you to answe.
3. Press [PTT]key to have a call. LED indicator becomes red. walkie talkie under the emergency call mode .
4. Let go [PTT] key to receive, when reply the emergency call, LED indicator becomes green. The screen shows group mark or ID and call ID
5. After the call, short-press [] key, then press pre-programmed emergency key to off , delect all the emergency call and logout.
6. Radio back to home screen.

Emergency Alarm

This function called not-speech signal and allows to send emergency alarm and will trigger on another radio .

1. Press pre-programmed power on key.
2. Screen shows sending emergency call, exchange ID with other walkie talkie .LED indicator changes to red and emergency call mark will down on the home screen .
3. When receive the emergency call, the radio issues the emergency call and LED indicator changes to green , screen shows emergency call send out successfully .

Or , if the radio does not receive any confirm with the emergency call and out of the sending times, the radio will with a message sound and screen shows the emergency call failed .

4. Radio logout the emergency mode and back to home screen .If the radio under silence mode, there will not any sounds or reminder during the emergency mode .

Emergency Alarm call

This function allows you to send emergency call to other radio .After confirmed by the radio , the two radios can contact by a pre-programmed channel .

1. Press pre-programmed key to switch on
2. Screen shows sending emergency alarm call,exchange ID . LED indicator becomes red, emergency call mark will down on screen .
3. when the radio confirm with the sending emergency,screen will show emergency call successful and LED indicator change to green .

4. Hold the radio and place it between your lip with 2.5~3cm .

5. Press[PTT]key to call,LED indicator light changes to red, screen shows the group mark.

6. Let go [PTT] key to receive .

7. If on the "free channel message sound" function, let go [PTT] key, you can hear a message sound (means it channel is free for you to answer)

Or press pre-programmed emergency call to off and logout the mode.

8. Radio back to home screen. If the radio is under the silence mode ,there are not any sounds or notices during the emergency mode, not receive calls from target walkie talkie ,until press the [PTT] key .If the radio under "with voice mute" mode ,there are not any sounds or notices during the emergency mode ,not receive calls from target walkie talkie .Until press the [PTT]key to call or receive, then the screen will show up .

Voice emergency Alarm

This function allows you to send emergency call to others ,after confirm with you, your radio microphone activate, allows you to call other radios with press the [PTT] key. This called "Emergency microphone".If press [PTT] key during pre-programmed emergency microphone. radio without ignore the [PTT] and stay on emergency mode .

Notice: If press[PTT]key during the emergency microphone ,hold the key before duration within limits, let go [PTT]key to transfer .

1. Press the pre-programmed emergency start key .

2. Screen shows sending emergency call, LED indicator becomes red color and emergency call Mark will show on Screen .

3. Screen will show emergency call successful, then speak clearly .When under activated emergency microphone, radio transfer automatically without press [PTT] key before duration within limits
4. During transfer , LED indicator becomes red and emergency alarm mark will show on screen.
5. After the time of emergency microphone, radio stop to transmit .Press [PTT] key to transmit again If the radio under the "Silence" mode, there are not any sounds or notices during the emergency mode, not receive calls from target walkie talkie, until pass the pre-programmed emergency microphone limited time and press with [PTT] key .If the radio under "with voice mute" mode ,there are not any sounds or notices during the emergency mode ,not receive calls from target walkie talkie .Until press the [PTT]key to call or receive, then the screen will show up .

Notice: If the emergency call failed , then the walkie talkie will back to home screen .

Restart Emergency Mode

Two situations will be happen:

- It will logout the emergency mode , if the walkie talkie change the channel under the emergency mode .While , reset the emergency mode under the new channel , the walkie talkie restart the emergency call .
- If press the Pre-programmed emergency key during the emergency call , the walkie talkie will be stop the emergency call but restart later .

Logout Emergency Mode

The walkie talkie will logout emergency mode when any of the following situations happen.

- Confirm with the received emergency call, or
- Meet with the max emergency call, or
- press the pre-programmed emergency off key, or
- Press[PTT]key.

Notice: Emergency mode will be logout when power off the walkie talkie.Radio will not under emergency mode when the radio is power on next time.

Menu operation Settings

Professional FM Transceiver

Menu operation

Character Input

Users can use the 3 x4 alphanumeric keypad to access the radio's function. When you're Using the keypad to input a user alias or text messages, walkie-talkie input contains three modes:1, English letters mode,2,chinese input mode, 3,digital input mode. When using the keypad input ID, you can only select the digital mode.

English Typing:

Users have to press a button several times for getting some characters. The following table shows how many times needed to press a button to get the required character.0

Button	1	2	3	4	5	6	7	8	9	10	11	12	13
1	1	.	,	?	!	@	&	'	%	-	:	*	#
2	a	b	c	2	A	B	C						
3	d	e	f	3	D	E	F						
4	g	h	i	4	G	H	I						
5	j	k	l	5	J	K	L						
6	m	n	o	6	M	N	O						
7	p	q	r	s	7	P	Q	R	S				
8	t	u	v	8	T	U	V						
9	w	x	y	z	9	W	X	Y	Z				
0	0	Space											
*	*												
#	Press # to switch mode.												

Chinese Typing

Number 1 is a button of punctuation s selection input ,Number 2-9 are correspond Pinyin input , when user input something, the screen shows the pinyin input interface, the first line of interface shows the contents inputted by user., second line of interface shows the Chinese characters what users input. When the content of the pinyin input interface show in the first row,users can press [▲ or ▼] to select Pinyin, users can press [☒] button to delete the Pinyin what they inputted previously one by one, when all the Pinyin characters were deleted, Pinyin input interface disappears. Press [☒] button to choose corresponding Chinese characters and display them in the editing area, At this time the Chinese character input finished, Pinyin input interface disappears. . Pressing* button shows *, pressing 0 button shows space, press # to switch input modes.

Numeral Writing

When in the Numbers input mode, press the number keys to display the corresponding number, press the "key to display" on the screen, press # to switch input mode.

Note: When users Enter a user alias, ID, or text messages, if editing area without any content, then the [☒] button is used for returning to the higher level menu, or else if there is any content on the editor area, pressing [☒] will delete one character before the cursor at one time, until the editing area has no content ,then press the [☒] button to return to the higher level menu.

Menu Application

1. Press [☒] to enter Menu, then press left or right [▲ or ▼] to access the menu function
2. Press [☒], select a function or go into a sub menu
3. Press [☒] to return the higher level menu

Note: After a period of time not activity radio will automatically exit and return to the main menu screen (hang time is set by the programming software).

Radio chcek

If there are any activation, this feature allows you to determine whether there is other two way radio active inside the system, and does not disturb the walkie-talkie users, none-voice or visual notice appears on the target two way radio

Send Radio Check

Using Menu:

1. Press [☒] to enter Menu
2. Press [▲ or ▼] button to select Contacts, then press [☒] to select.
3. Press [▲ or ▼] toThe required user alias or ID,then press [☒] to select
Or press [▲ or ▼] key to manual dialing, and then press [☒] key to select. If there are before calling ID, show ID and along with the flashing cursor, using the keyboard editing ID, press [☒] .
4. Press [▲ or ▼] to radio detection, and then press [☒] to select

5. When Screen displays radio detection: < user alias or ID >, it is indicating the ongoing of radio detection. The LED indicator light is red.

6. Waiting for confirmation

7. If the target radio is active in the system , then it makes a prompt sound, screen will show that target two way radio has responded shortly.

Or if the target radio in the system is not active, then it makes a prompt sound, screen will show that target two way radio has no answer shortly.

8. Two way radio returns to user alias or ID screen. If you press [] when waiting for confirmation, made a prompt sound, two way radio will end all retry and exit the two way radio detection mode.







Monitor

Using monitoring function to open the target two way radio's microphone (only the user alias or ID). You can use the function to monitor any sound around target two way radio.

Your must allow your two way radio to use this function by programming it.



Start Monitor

Using the Menu:

1. Press [] to enter the Menu
2. Press [ or ] to Contacts, then press [] to select
3. Press [ or ] to The required user alias or ID, then press [] to select

Or press [ or ] key to manual dialing, and then press [] key to select

If there are any calling ID remains before, radio shows the ID and along with the flashing cursor, using the keyboard to edit the ID, press [] key to choose.

Or press [ or ] key to manual dialing, and then press [] key to select. Inputting the user alias or ID, and then press [Ok] key to select.

4. Press [ or ] to select Remote Monitor then press [] to select

5. When two way radio makes a prompt sound, LED light turns green.

6. Waiting for confirmation.

7. Screen displays Monitor succeeded,

Or screen displays Monitor failed

If success: two way radio began to receive voice signals from the radios which are being monitored voice and screen displays two way radio are monitoring, until the end of the duration of the preprogrammed, two way radio made a prompt sound, and the LED light puts out, screen display that monitoring ends.

If failed: two way radio Repeats until reach the preprogrammed attempts.

Contacts setting







Contacts is "address book" for handheld two way radio. Each entry corresponds to an alias or ID used to start the call. In addition, each item, according to the different content setting, relate to three types of call: group calling, single call, all call. Your radio support digital address book.

The Contacts' entries display in the following information













- Contacts
- New Contact
- Manual Dial

Note: you can add, delete, edit Contacts person in the digital address book(contacts)

Group Call With Contacts

1. Press [] to enter Menu
2. Press [ or ] to contacts, then press [] to choose, entries arrange in alphabetical order.
3. Press [ or ] to required calling group's alias or ID.
4. Holding the radio and let it in a vertical position and keep mouth 1 to 2 inches (2.5 to 5.0 cm) with radio.
5. Press [PTT] to start calling, the LED turns red. The screen displays the calling group's alias or ID,as well as icon of group call.
6. Releasing (PTT) button to receive, when any user response within the group, the LED light turns green. You will see on the screen group call icon of user's ID
7. if you enable the "channel Free prompt " function: when the target radio release the (PTT) button, you will hear a short beep, said this channel is idle, waiting for your answer. Press the call key (PTT) to answer. If in a preprogrammed group called hang time without voice activity, the call is ended.

Single Call With Contacts

1. Press [] to enter Menu
2. Press [ or ] to Contact,then press [] to choose, entries arrange in alphabetical order.
3. Press [ or ] to required calling group's alias or ID.
Or press [ or ] key to manual dialing, and then press [] key to choose. If there is a user alias or ID called before, radio shows ID and along with the flashing cursor, using the keyboard editing this ID.
Or press [ or ] key to manual dialing, and then press [] key to choose, using the keyboard to enter a new ID
4. Holding the radio and let it in a vertical position and keep mouth 1 to 2 inches (2.5 to 5.0 cm) with radio.
5. Press [PTT]to start calling, the LED turns red. The screen displays the calling group's alias or ID,as well as icon of group call.
6. Releasing (PTT) button to receive, when any user response within the group, the LED light turns green. You will see on the screen group call icon of user's ID
7. if you enable the "channel Free prompt " function: when the target radio release the (PTT) button, you will hear a short beep, said this channel is idle, waiting for your answer. Press the call key (PTT)to answer. If in a preprogrammed group called hang time without voice activity, the call is ended.
8. You will hear a sound short, screen shows the call ended

Note:







If you release (PTT) button when you are setting up the call, and when it will exit and return to the previous screen without any remind. Radio can be preprogrammed executive two way radio are testing before establishing single call. If the target radio did not reply, you will hear a short beep, and screen shows the other radios did not reply. Two way radio return to menu before starting the radios around test.

Call Log

Your radio can record all the recent dialed, received, and not answered call. Use the calling record function view and manage the recent calls.

Checking New Call's Number

Menu items can show the not answer call ,received calls and dialed call.





1. Press [] key to enter the menu mode.
2. Press the [ or ] key to the Call Log, and then press [] key to choose.
3. Press [ or ] to the required list, and then press [] key too choose.
4. The screen on the top of the list shows the recent entries.
5. Press [or]check list, press (PTT) at the current selected aliases or ID to start a call.

Missed Call















Whenever you miss call, two way radio will display a not answered call, select view or view later.

Note:







If you press (PTT),when you're viewing missing call number, radios will exit the missing call screen and establishing a single call again.

1. The screen shows the missing call, and the missing call's number and view.
2. Press [] view missing call's ID, missing call's record list displayed on the screen. Press [] to store or delete this entry; Or press [ or ] key to view later, and then press [] key choice, return to the main screen.

Storing Missed call's Alias Or ID

1. Press [] key to enter Menu.
2. Press the [ or ] key to Call Log, and then press [] key to choose.
3. Press the [ or ] key to missed call, and then press [] key to choose.
4. Press [ or ] key to missed call's alias or ID, and then press [] key to choose
5. Press the [ or ] key to store, and then press [] key to choose
6. Radio Shows flashing cursor, if needed, enter the ID alias, and then press [] ey.
7. The screen contacts have been saved.
You can also enter ID without alias.

Deleting Calling Log's Record

1. Press [] key to enter the Menu.
2. Press the [ or ] key to Call Log and then press [] key to choose.
3. Press the [ or ] key to missed call, and then press [] key to choose.

4. Press [▲ or ▼] key to missed call's alias or ID, and then press [☒] key to choose
5. Press [▲ or ▼] key to delete the entries, then press [☒] key to select if you need to delete this entry.
6. Select "yes", then press [☒] key to delete the entries, screen appears entry deleted; Or select "no", press [☒] key to return to previous screen.

When you select a call list but there is no entry in, the screen will display the list is empty, if the keyboard is open at this time, will be a low tone hint sound.

Call Alert Operation

Call alert makes you can suggest a specific radio users in the possible time to call you back.

This feature applies only to the user alias or ID, and can be used through the menu by address book or manual dialing.

Receiving And Checking Call Alert

When you receive a call alert, screen shows call prompt, alternating transmit radio's alias or ID

1. YOU will hear sound of repeat, LED light turn and shine red.
2. Then press and release [PTT] to confirm the prompt, or press [☒] to select "neglect" to exit the call reminder.

Starting Call Alert From Contact List

1. Press [☒] key to enter the Menu.
2. Press the [▲ or ▼] key to Contacts, and then press [☒] key to choose.
3. Press [▲ or ▼] key to missed call's alias or ID, and then press [☒] key to choose Or press [▲ or ▼] key to manual dialing, and then press [☒] key to choose, a flashing cursor appears, then enter the user ID you want to call, and then press [☒] key.
4. Press [▲ or ▼] key to Call Alert, the screen display Call Alert: < user s alias or ID >, and then press [☒] key and instructions have been sent Call Alert.
5. When the radio send call alert, the LED indicator for the red light.
6. If you receive calls prompt confirmation, issued a prompt, and display the call alert success.

Or prompt confirmation if not received a call, send a hint sound, and the screen call failure.

Messages Function

Your radio can receive data, such as from another radio sent text messages, message of a maximum length of 144 characters, whole message is not longer than 50 lines.

Edit And Send SMS

Using the Menu

1. Press [☒] key to enter the Menu.
2. Press the [▲ or ▼] key to Messenger, and then press [☒] key to choose.
3. Press [▲ or ▼] key to write, and then press [☒] key.

4. A flashing cursor appears, using the keyboard to input messages, press [▲] key to move to the left one, press [▼] button to the right one, when editing area have content, press the [⌫] key to delete any useless character, otherwise when editing area without content to return to the higher level menu.
5. After writing the text, press [⌫] to choose to send or save.
6. When on the process of editing, user can choose by pressing the [⌫] key to empty option to empty all the content of the editor, quickly return to the higher level menu.
7. Choose the [▲ or ▼] key to the alias name or ID, and then press [⌫] key to select . Or press [▲ spending] key to manual dialing, and then press [⌫] button, enter your user ID and press [⌫] key.
8. The screen shows message: < user/group name or ID > call, sending message are being confirmed
9. If the messages sent successfully, issued a prompt sound, and the screen displays text message has been sent.

Or if the message was not sent, issued a high tone hint sound, and screen displays text message sent failure. If message sent failure, radio will return to chance to return to the retransmission selection screen

Send Quick Text

Two way radio support maximum 50 programming of prefabricated text messages by the agent:

When a predefined text message, you can edit every message before you can send each message.

Using the Menu

1. Press [⌫] key to enter the Menu.
 2. Press the [▲ or ▼] key to Messages, and then press [⌫] key to choose.
 3. Press [▲ or ▼] key to Quick Text, press [⌫] key to choose
 4. Press [▲ or ▼] key to the required quick text, press [⌫] key to choose
 5. A flashing cursor appears, using the keyboard to input messages, press [▲] key to move to the left one, press [▼] button to the right one, when editing area have content ,press the [⌫] key to delete any useless character, otherwise when editing area without content to return to the higher level menu.
 6. After writing the text message, press [⌫] to choose to send or save.
 7. If the messages sent successfully, issued a prompt sound, and the screen displays text message has been sent.
- Or if the message was not sent, issued a high tone hint sound, and screen displays text message sent failure. If message sent failure, radio will return to chance to return to the retransmission selection screen.
8. After Choose send press [▲ or ▼] to the alias or ID, and then press [⌫] key to choose. Or press [▲ or ▼] key to manual dialing, and then press [0 k] key choice. Enter the user alias or ID, then Press [⌫].
 9. The screen shows message: < user/group name or ID > call, text messages were a being sent to confirm.
 10. If the messages sent successfully, issued a prompt sound, and screen display text

message has been sent. Or if the message can't send, send out a high tone hint sound, screen display message sent failure, failure if the SMS messages, intercom chance to return to the retransmission selection screen.

Send Quick Text With A Key

1. Press Preprogrammed, single bond calls to a predefined alias or ID sends a prefabricated text messages.
2. The screen displays a text message: < user/group name or ID > call, to confirm text messages were being sent
3. If the messages sent successfully, issued a prompt sound, and the screen display text message has been sent.

Or if you cannot send text messages, screen display text message sent failure. If message sent failure, intercom chance to return to the retransmission selection screen.

Manage The Failed SMS

In retransmission selection screen, you can choose the following options:

- Resend,
- Forward,
- Edit











Resending message

1. Press [] to resend same message to same user/group name or ID.
2. If the messages sent successfully, issued a prompt sound, and display messages sent or

if you cannot send text messages, screen display text message sent failure.

Forwarding message

Choose to forward message to another User/group name or ID.





1. Press the [ or ] key to forward, and then press [] key choose.
2. Press [ or ] to the alias name or ID, and then press [] key to choose.
Or press [ or ] key to manual dialing, and then press [] button to choose, enter your user ID and press [] key.
3. The screen display a text message: < user/group name or ID > call, to confirm text messages were being sent
4. If the messages sent successfully, issued a prompt sound, and the screen display text message has been sent.

Or if the message was not sent, issued a high tone hint sound, and screen displays text message sent failure.

Editing messages

Choosing edit to edit message before you edit.

Note: if you have a subject line (receive text messages from email program), you can't edit the subject line.

1. Press [ or ] key to edit, then press [] key to choose
2. A flashing cursor appears, using the keyboard to input messages, press [] key to move to the left one, press [] button to the right one, when editing area have content,

press the [**ESC**] key to delete any useless character, otherwise when editing area without content to return to the higher level menu.

3. After writing the text, press [**ESC**] choose to send or save
 4. When in the process of editing, can choose by pressing the [**ESC**] key to empty option to empty all the content of the editor, quickly return to the higher level menu
 5. Choose after [**▲** or **▼**] button to send the required alias or ID, and then press [**ESC**] key to choose
- Or press [**▲** or **▼**] key to manual dialing, and then press [**ESC**] button, enter your user ID and press [**ESC**] key
6. Screen displays message: < user/group name or ID > call, to confirm text messages were being sent
 7. If the messages sent successfully, issued a prompt sound, and the screen display text message has been sent.

Or if the message was not sent, issued a high tone hint sound, and screen displays text message sent failure.

Manage The Sent SMS

Once a message is sent to another radio, it will be saved in the "sent items". Send after sending a text message has always been to "sent items" at the top of the list. The sent items folder can store up to 50 recently send text messages. After the folder is full, the next send text messages will automatically replace the earlier messages in this folder.

Note: at any time pressing the [**ESC**] key can return to the previous screen.

Check the sent messages

Using the menu function:

1. Press [**ESC**] button to enter the Menu.
2. Press the [**▲** or **▼**] key to Messages , and then press [**ESC**] key to choose
3. Press [**▲** or **▼**] to sent items, and then press [**ESC**] key to choose
4. Press the [**▲** or **▼**] key to the SMS, and then press [**ESC**] key choose. If the message from the email program, a subject lines, will appear in the top right corner of the screen icon indicates state of SMS.



Sending the sent messages

When the view sent messages, you can choose the following options:

- Resend
- Forward,
- Edit
- Delete

1. Check the message, press [**ESC**] key again
2. Press the [**▲** or **▼**] key to resend, then press [**ESC**] key to choose.
3. The screen displays: < user/group name or ID > call, confirm that it is preparing to send the same message to the same target radio
4. If the messages sent successfully, issued a prompt sound, and the screen display text message has been sent.

Or if the message was not sent, issued a high tone hint sound, and screen displays text message sent failure. If message sent failure, intercom chance to return to the retransmission options screen. Press the [] key to send SMS weight to the same user/group name or ID.

Note: Except for Pressing the [], [ or ] key, if you change the volume and the press any other key, will return to this message. When you press [PTT] for a single call or group call, or as a response to the group calling, radio will exit the retransmission selection screen. If received text messages or remote sensing information, emergency call, or call the police, or call reminder, radio will exit the retransmission selection screen.











If you press [PTT] in response to a single call (in addition to the radio in the show did not answer the call screen), or at the end of all call, the screen will return to resend selection screen. Press [] key, enter the forwarding, edit, or delete selection screen.



- choose forward, will choose the SMS sent to speak to other groups/user alias or ID.
- choose to edit, to edit the selected text messages before sending
- choose delete, delete the selected text.

Note: if you screen out SMS messages when send text messages, so radios will be in the "sent items" folder for SMS status updates, not the tip or by voice prompt. If the messages in the sent items folder state before update, walkie-talkie pattern changed or blackout, walkie-talkie will not be able to complete the ongoing message processing, and automatically start tag to the icon of failure. This radio can handle 5 text messages at the same time. At this stage, the radio can't send a new message, and automatically start tag icon to send failure.

Deleting all Sent Messages In the "sent items"

Using the Menu Function

1. Press the [] button to enter the Menu.
2. Press the [ or ] key to Messages, and then press [] key choice.
3. Press [ or ] to Sent Items, and then press [] key choice.
4. Press the [ or ] key to delete all, and then press [] key choice.
5. When it appears to delete messages, press [] button, select "yes" project has clear screen display has been sent.

Or delete the text, press [ or ] to no, and click [] key to return to the previous screen. When you select the "sent items" but not one of them text messages, the screen will display the list is empty, if the keyboard is open at this time, will be a low tone hint sound.

Receive SMS

When your radio are receiving SMS, the left of the screen shows the sender alias or ID

ICONS and text messages.

When receive text messages, you can choose the following options:

- reading?
- Reading Later
- delete

Note: when the radio shows tip on the screen, please press (PTT), two way will exit and to establish a single call or text message screen group call.

Check the SMS

1. Press the [▲ or ▼] key to Read, And then press [☰] key to choose
2. the selected text messages on the inbox opened, if the message is from the email program, it will appear a subject line.
3. Click [☰] key to return to your inbox.

Or press [☰] to reply,forward or delete messages.

Press [▲ or ▼] key to enter later view or delete selection screen:

Later, select view screen before returning to receive messages.

Choose delete, delete receive text messages.

Manage Received SMS

Use your inbox to manage messages. inbox can store up to 50 text messages at Most.

Two way radio supports the following text options:



- Reply
- Forward
- delete
- Delete all

store the message in the inbox in the order of received time .

Note: at any time according to the [☰] key can return to the previous screen.

















Check The Inbox SMS





1. Press the [☰] button to enter the Menu.
2. Press the [▲ or ▼] key to Messages, and then press [☰] key to choose
3. Press [▲ or ▼] to the inbox, and then press [☰] key to choose.
4. Press the [▲ or ▼] key to check the message. If the messages are from the email program, it will appaer a subject line.
5. Press the [☰] key to choose the current text, then press [☰] key again to reply, delete, or forward this message.

Unread messages:  , Already read message: 

Reply The Inbox SMS

Use the menu function:

1. Press [] button to enter the Menu.
2. Press the [ or ] key to message, and then press [] key to choose
3. Press [ or ] to the inbox, and then press [] key to choose
4. Press the [ or ] key to the SMS, and then press [] key to choose. If the messages are from the email program, it will appear a subject line.
5. Press again [] button to enter submenu.
6. Press [ or ] to reply, and then press [] key to choose.
7. Press [ or ] to write messages, and then press [] key choice, a flashing cursor, using a keyboard editing text messages.

Or press [ or ] key to prefabricated text messages, and then press [] key to choose. Choose the required message after press [] a flashing cursor, if needed, with the keyboard editing your message.

8 After Writing the text, press [] .

















9. The screen displays message : < user/ call group name or ID >, to confirm. text messages were being sent

10. If the messages sent successfully, issued a prompt sound, and screen display text message has been sent.

Or if you cannot send text messages, screen display text message sent failure. If message sent failure, radio return to the retransmission selection screen.













Deleting the inbox messages

Use the menu function:

1. Press the [] button to enter the Menu.
2. Press the [ or ] key to message, and then press [] key to choose
3. Press [ or ] to the inbox, and then press [] key to choose
4. Press the [ or ] key to the SMS, and then press [] key choice. If the messages are from the email program, it will appear a subject line.
5. Press again [] button to enter submenu.
6. Press the [ or ] key to delete, and then press [] key to choose.
7. Delete messages, press [ or ] key to "yes", then press [] key to choose.
8. Screen appears short message has been deleted.
9. The screen back to inbox.

Deleting all messages in the inbox

Use the menu function:

1. Press the [] button to enter the Menu.
2. Press the [ or ] to the Message, and then press [] key to choose.
3. Press [ or ] to the inbox, and then press [] key to choose.
4. Press the [ or ] key to delete all, and then press [] key to choose.
5. When it appears Deleting the messages, press [ or ] select yes, and then press [] key to choose
6. Then The screen inbox was empty already.

When you select the "inbox" but not one of them text messages, the screen will display the list is empty, if the keyboard is open at this time, will be a low tone hint sound.

Encryption

If you enable this feature, which is beneficial to prevent other users on the channel by using the method of software encryption for unauthorized eavesdropping. The launch of signaling and user identification part unencrypted. Your radio must be enabled on the channel encryption function, can send encrypted, even if the receiving transmission is not must request to do so.

Basic encryption

Two way radio can only be assigned more than one type of encryption. If users Call for encryption or decryption of data transmission, must make to be preprogrammed walkie-talkies and launch radio has the same "encryption keys" (suitable for basic encryption).

If your radio to receive different encryption keys or key values and key encryption call ID, you will hear the sound of the transport chaos encryption (basic).

Press the preliminary programming encryption keys on or off.

DTMF

Dual Tone Multi-Frequency (DTMF) function allows to operate radio when there is interference in the radio system.

To initiate a DTMF call

1. Press and hold [PTT] key.

2. Enter number you need.

You can disable DTMF tone by turning off all radio tone and prompts.















Secrecy

You can activate or kill any radio in the system. For example, you might want to disable a stolen radio, to prevent thieves use it, and enable it when you get it back.

Note: radio kill or activation is limited to activate the radios with these functions.















Radio Disable

Use menu mode

1. Press [] key to enter the menu mode.
 2. Press [ or ] key to Contacts, and then press [] key to select, entries are in alphabetical order.
 3. Press [ or ] key to the required alias or ID, and press [] key to select.
Or press [ or ] key to Manual Dial, then press twice [] key to enter a user alias or ID, and press [] key to select.
 4. Press [ or ] key to radio disable, and then press [] key to select.
 5. The display shows the radio disable: <user alias or ID> and the LED indicator light is red.
 6. Wait for confirmation.
 7. If successful, emit a beep and the screen displays radio disable successfully.
Or if it fails, emit a beep and the screen displays radio fail to disable.
- During radio disable operation, do not press the [] key, because you will not get a confirmation message.

Radio Enable

Use menu function:

1. Press [] key to enter the menu mode.
 2. Press [ or ] key to Contacts, and then press [] key to select, entries are in alphabetical order.
 3. Press [ or ] key to the required alias or ID, and press [] key to select.
- Or press [ or ] key to Manual Dial, then press twice [] key to enter a user alias or ID, and press [] key to select.
4. Press [ or ] key to radio enable, and then press [] key to select.
 5. The display shows the radio enable: <user alias or ID> and the LED indicator light is red.
 6. Wait for confirmation.
 7. If successful, emit a beep and the screen displays radio enable successfully.









Or if it fails, emit a beep and the screen displays radio fail to enable.



During radio enable operation, do not press the [] key, because you will not get a confirmation message.



Scanning List

Create a scan list and assign to a single channel / talkgroup, your radio can support up to 250 scan lists, each up to 16 members. Each scan list support mixed analog and digital channels. You can edit the scan list to add / delete channels or set the priority channel.

Check members of list

1. Use the channel knob to select a channel with pre-programmed scan list;
2. Press the [] key to enter the menu mode;
3. Press [ or ] key to scan, and then press the [] key to select;
4. Press [ or ] key to Viewlist the list, and then press the [] button to select;
5. Use [ or ] key to see members of list.

If you set the priority, the priority icon is displayed in the left of member alias, indicating that the member is the Priority  or Priority  channel; if the priority is set to  , no priority icon.

In a scan list, you can not have more than one Priority  or Priority  channel.

Scanning Instruction

When scanning, your radio can view if there is a voice activity in current channel through circulating pre-programmed scan list. LED lights flashing for a red light, and the scan icon  appears on the screen.

When scanning in dual mode, if you're in a digital channel and your radio locking an analog channel, radio will switch automatically from digital mode to analog mode throughout the







duration of the call. And vice versa.

There are two scanning methods

- Manual Scan: According to a pre-programmed scan on / off key or menu function to start the scan, when you start scanning, radio will detect all channels / contact groups on pre-programmed scan list.
- Auto Scan: When you select an already activated auto scan channels / contact groups, radio scans from the activated auto scan channel.

Start/Stop Scan

Press Pre-programmed Scan On / Off Key Or Enter The Scan Menu Function

1. Using the channel knob to select a channel of pre-programmed scan list;
2. Press [] to enter menu mode;
3. Press [ or ] to scan, and then press [] to select;
4. If the scan is disabled, the screen displays on or if the scan is activated, the screen displays off.
5. Press [] to select
6. When the scan is activated, LED indicator flashes red and displays scan icon  ; or when scanning is disabled, LED light goes out and does not display the scan icon.

Scanning reply

Radio detect active channel/contact group when scanning, at this time radio will stay in the channel/ contact group, which is called "Scan hang time" pre-programmed time.

Procedure:

1. Hold the radio in a vertical position and keep one to two inches (2.5 to 5.0 cm) distance from the mouth. If you enable the "channel idle tone" function, when transmitting radio release [PTT] key, you will hear a short beep, indicating that the channel is idle, waiting for your respond.
2. Within the hang time by pressing [PTT] button, LED indicator light is red.
3. Release [PTT] key to respond.
4. If you do not respond within the hang time, radio will continue down the scan

Utilities

Utilities includes the following contents:

- Radio settings
- Radio Info
- Program Radio

Radio Settings

Radio Setting includes:













- Talkaround
- Tones/Alerts
- Power
- Backlight
- Squelch
- Intro Screen
- Keypad Lock
- Language
- LED Indicator
- VOX
- Passwd Lock
- Clock
- Mode

Talkaround

When the transponder does not work, or when the radio located outside the range of the transponder but located within the range of other radios call, you can continue to communicate. This is called "talk around."

Press Pre-programmed repeater / talk around button, you can switch between repeater / talk around mode.

Use the menu function

1. Press [] key to enter the menu mode.
2. Press [ or ] key to utilities, and then press [] key to select.
3. Press [ or ] key to radio settings, and then press the [] key to select.
4. Press [ or ] key to talk around, and then press [] key to select.
5. If radio is currently in repeater mode, you can see the open, or if radio is currently in talk around you can see the close.
6. Press [] key to select.
7. Screen showing turn on talk around [] or turn off talk around.
8. The screen automatically returns to the previous menu.

Even after the shutdown, still remains talk around.

Tones/Alerts

including the following contents:















- All Tones
- Talk Permit
- Keypad Tones

All Tones

If desired, you can enable or disable all radio tone and prompts (except emergency incoming tone).

Press pre-programmed all Beep ON / OFF to turn on or off all radio tones.











Use the menu function:



1. Press [] key to enter the menu mode.
2. Press [ or ] key to utilities, and then press [] key to select.
3. Press [ or ] key to radio settings, and then press the [] key to select.
4. Press [ or ] key to tones/alerts, and then press [] key to select.
5. Press [ or ] key to all tone, and then press [] key to select.
6. Press [] key to select on, then enable all tone and prompts, screen displays all tone is open.

Or press [] key to select Off, then turn off all tones and prompts, screen displays all tone is off.

Keypad Tones

If desired, you can activate and deactivate call admission tone.

1. Press [] key to enter the menu mode.
2. Press [ or ] key to utilities, and then press [] key to select.
3. Press [ or ] key to radio settings, and then press the [] key to select.
4. Press [ or ] key to tones/alerts, and then press [] key to select.

5. Press [ or ] key to keyboard tone, then press [] key to select.

6. Press [] key to select Open, then enable the keyboard tone, the screen shows keyboard tone is turned on.











Press [] key to select off, then turn off the keyboard sound, the screen shows keyboard tone is turned off.

Power

You can set each channel power level to high or low. Setting: High-power radio implement communications with relatively far distance radios. Low-power radio implement communications with relatively close distance radios.

Press pre-programmed high / low power selection key, you can switch high / low transmit power.

Using the menu function:

1. Press the [] key to enter the menu mode.
2. Press [ or ] key to utilities, and then press [] key to select.
3. Press [ or ] key to radio settings, and then press the [] key to select.
4. Press [ or ] key to power, and then press [] key to select.
5. Follow the on-screen instructions to change the current settings.
6. Press [] key to select the new power level.
7. Return to the previous menu screen.











Press [] to return to the main screen, the screen displays the power level icon.

Backlight

You can turn on or off the screen backlight according to the need. This setting also affects the menu button and the keyboard backlight.

Press a pre-programmed automatic backlight key to switch backlight settings

Using the menu function:

1. Press [] key to enter the menu mode.
2. Press [ or ] key to utilities, and then press [] key to select.
3. Press [ or ] key to radio settings, and then press the [] key to select.
4. Press [ or ] key to backlight, and then press [] key to select.
5. The screen displays always open, 5S, 10S, 15S options, press [] key to select always open, the screen will remain lit and won't turn off, or if you choose 5S, 10S, 15S, the screen backlight will be off in the corresponding time under users without any operations.



Squelch

You can adjust radio squelch level, thus filtering low signal intensity useless call or channel higher than normal value. Setting: Normal is the default, strict filtering (useless) call or background noise. However, a call from a remote location may also be filtered out.



Press pre-programmed strict / normal squelch button to switch between normal and strict squelch level.

Using the menu function:

1. Press [] key to enter the menu mode.

2. Press [ or ] key to utilities, and then press [] key to select.

3. Press [ or ] key to radio settings, and then press [] key to select.

4. Press [ or ] key to squelch, and then press [] key to select.



5. Select strict or normal, and then press [] key to select.



6. The screen returns to the previous menu.

Intro Screen

If desired, you can enable and disable the Intro Screen display.

1. Press [] key to enter the menu mode.

2. Press [ or ] key to utilities, and then press [] key to tight.

3. Press [ or ] key to radio settings, and then press the [] key to tight.

4. Press [ or ] key to Intro Screen, then press [] key to select.



5. The screen is on, press [] key to enable the Intro Screen display, the screen displays the boot screen display on.

Or the screen is off, press [] key to close the Intro Screen display, the screen displays the boot screen display off.

Keypad Lock

You can lock the keypad to prevent accidental key input. Ways include manual and automatic keypad lock, which includes 5S, 10S, 15S three options.

1. Press [] key to enter the menu mode.

2. Press [ or ] key to utilities, and then press [] key to select.

3. Press [▲ or ▼] key to radio settings, and then press [☰] key to select.
4. Press [▲ or ▼] key to keypad lock, then press [☰] key to select.
5. Press [▲ or ▼] key to manual, and then press [☰] key to select, screen show to select Manual, you need to long press [🔒] key to lock keypad on the main interface.
6. Press [▲ or ▼] key 5S, 10S, 15S, the screen shows to select the corresponding time, then keypad will be locked and return to the main screen if user have not any keypad operation after corresponding period of time.
7. To unlock the keypad, press [☰] key, then press [🔓] key.
8. Screen shows unlock keyboard, and then return to the main screen.

Language

Radio supports the following languages:

- English
- Chinese

1. Press [☰] key to enter the menu mode.
2. Press [▲ or ▼] key to utilities, and then press [☰] key to select.
3. Press [▲ or ▼] key to radio settings, and then press [☰] key to select.
4. Press [▲ or ▼] key to the language selection, then press [☰] key.
5. Press [▲ or ▼] key to the corresponding language option, then press [☰] key.
6. Screen displays to select corresponding language, and then jump back to the main interface.

LED Indicator

If desired, you can activate and deactivate the LED.

1. Press [☰] key to enter the menu mode.
2. Press [▲ or ▼] key to utilities, and then press [☰] key to select.
3. Press [▲ or ▼] key to radio settings, and then press [☰] key to select.
4. Press [▲ or ▼] key to LED indicator, and press [☰] key to select.
5. The screen displays open, press [☰] button to enable LDE light, screen shows to turn on the LED light.

Or The screen displays off, press [☰] button to turn off the LED light, screen shows to turn off the LED light.

If you disable the LED light, buttons and keyboard backlight automatically turns off.

VOX

This function allows you to initiate voice-activated hands-free calls on pre-programmed channels. Whenever a microphone with VOX function detect voice, radio will automatically transmit signals within pre-programmed period of time.











During radio operation press [PTT] key will disable VOX function, to re-enable the VOX function, do one of the following:

- Turn off and return on radio
- Through the channel knob to change the channel, or
- Perform the following procedure:



















Note: Enabling or disabling this function is limited to activate radios of these function.

Press pre-programmed VOX on / off key, to turn on or off this function.

Using the menu function:

1. Press [] key to enter the menu mode.
2. Press [ or ] key to utilities, and then press [] key to select.
3. Press [ or ] key to radio settings, and then press the [] key to select.
4. Press [ or ] key to VOX, and then press [] key to select.
5. Screen shows VOX off and VOX level 1-10S, if you choose to turn off, press [] key to disable the VOX function, emitting a beep and the screen displays VOX off. If you choose 1-10S, VOX function is enabled, and the voice transmit sensitivity is on the corresponding level. If you activate the call allowing sound, you can initiate a call using a trigger word. Waiting sound end (if activated), and then speak clearly into the microphone.

Passwd Lock

1. Press [] key to enter the menu mode.
2. Press [ or ] key to utilities, and then press [] key to select.
3. Press [ or ] key to radio settings, and then press [] key to select.
4. Press [ or ] key to passwd lock password, and then press [] key.
5. Use the keypad to enter the correct 8 digits password (You can pre-set by software), and then press the [] key.
6. If the password is incorrect, the screen displays an error code. If the password is correct, the screen displays options.
7. If the first line shows open, press [] key to display the power-on password application. Next time you need to enter the correct password to turn on radio. If the first line shows off, press [] key to display the power-on password cancellation, next time you can directly turn on radio.
8. Press [ or ] key to change power-on password, and then press [] key to select.
9. Enter 8 digits new password, and then press [] key to select.
10. Once again, enter 8 digits new password, and then press [] key to select.
11. Screen displays that password was successfully changed.

















Note: The power-on password must be set to eight digits.

Clock

















Clock settings are divided into:

- Time
- Date

Time













1. Press [] key to enter the menu mode.
2. Press [ or ] key to utilities, and then press [] key to select.
3. Press [ or ] key to radio settings, and then press [] key to select.
4. Press [ or ] key to clock, and then press [] key.
5. Press [ or ] key to time, and then press [] key to display the current time.
6. Press [] key to enter time setting interface.
7. Press [ or ] key to move left and right to select the desired number, the selected number will reverse video display, then enter the corresponding numbers to change the time via the numeric keypad.
8. Press [] key to save, the screen displays the time has been saved.

Date

1. Press [] key to enter the menu mode.
2. Press [ or ] key to utilities, and then press [] key to select.
3. Press [ or ] key to radio settings, and then press [] key to select.
4. Press [ or ] key to clock, and then press [] key.
5. Press [ or ] key to date, and then press [] key to display the current date.
6. Press [] key to enter the time setting interface.
7. Press [ or ] key to move left and right to select the desired numbers, the selected numbers will reverse video display, then enter the corresponding number to change the date via the numeric keypad.
8. Press [] key to save, the screen displays the date has been saved.

Mode

Mode settings are divided into:

- CH Mode
 - MR Mode
1. Press [] key to enter the menu mode.
 2. Press [ or ] key to utilities, and then press [] key to select.
 3. Press [ or ] key to radio settings, and then press [] key to select.
 4. Press [ or ] key to mode and then press [] key.
 5. Press [ or ] key to select CH mode or MR mode, then press [] key to select the

corresponding mode, the screen displays this mode is selected.

6. The main screen will show channel name or frequency (receiving frequency) according to the selected mode.











Radio Info

Radio contains the following information:

- My Number
- Versions







Note: At any time you can return to the previous screen by pressing the [] key.



My Number

1. Press [] key to enter the menu mode.
2. Press [ or ] key to utilities, and then press [] key to select.
3. Press [ or ] key to radio information, and press [] key to select.
4. Press [ or ] key to my number, then press [] key.
5. The display shows radio ID and name.

Versions

Display radio firmware version.

1. Press [] key to enter the menu mode.
2. Press [ or ] key to utilities, and then press [] key to select.
3. Press [ or ] key to radio information, and press [] key to select.

4. Press [ or ] key to radio versions, and then press [] key.

5. The screen will display the current firmware version, Codeplug version.













Program Radio

Radio configuration mainly includes editing the channel contents



Channel contents can be edited include:

- RX Frequency
- TX Frequency
- Channel Name
- Time out Timer
- CTC/DCS
- Color Code
- Repeater Slot

Rx Frequency















1. Press [] key to enter the menu mode.
2. Press [ or ] key to utilities, and then press [] key to select.
3. Press [ or ] key to program radio, and then press [] key to select.
4. Use the keypad to enter the correct Program radio password (programmed by software), and then press [] key to select.
5. Press [ or ] key to receiving frequency, and then press [] key to select.
6. The screen displays receiving frequency of the current channel, and then press [] key

to select.

7. Press the number keys to enter the corresponding number, press [] key to delete the last number, press [] to return to the previous menu.
8. After finish the change, press [] key, the screen displays receiving frequency has been saved.

Note: Editing frequency will be limited within the frequency range setted by programming software, if less than the write frequency range setted by software, the final change result will be the minimum frequency of frequency range setted on software, otherwise it is maximum.













Tx Frequency

1. Press [] key to enter the menu mode.
2. Press [ or ] key to utilities, and then press [] key to select.
3. Press [ or ] key to program radio, and then press [] key to select.
4. Use the keypad to enter the correct Program radio password (programmed by software), and then press [] key to select.
5. Press [ or ] key to transmitting frequency, and then press [] key to select.
6. The screen displays transmitting frequency of the current channel, and then press [] key to select.
7. Press the number keys to enter the corresponding number, press [] key to delete the last number, press [] to return to the previous menu.















8. After finish the change, press [] key, the screen displays transmitting frequency has been saved.

Note: Editing frequency will be limited within the frequency range setted by programming software, if less than the write frequency range setted by software, the final change result will be the minimum frequency of frequency range setted on software, otherwise it is maximum.

Channel Name

1. Press [] key to enter the menu mode.
2. Press [ or ] key to utilities, and then press [] key to select.
3. Press [ or ] key to program radio, and then press [] key to select.
4. Use the keypad to enter the correct Program radio password (programmed by software), and then press [] key to select.
5. Press [ or ] key to the channel name and press [] key to select.
6. The screen displays the current channel name, press the [] key to switch the input method to enter the relevant letters, numbers or characters, the same as the input method and text editing.
7. After the change is complete, press [] key, the screen displays channel name has been saved.

TOT







1. Press [] key to enter the menu mode.
2. Press [ or ] key to utilities, and then press [] key to select.
3. Press [ or ] key to program radio, and then press [] key to select.
4. Use the keypad to enter the correct Program radio password (programmed by software), and then press [] key to select.
5. Press [ or ] key to TOT, and then press [] key to select.
6. The screen displays infinite, 15S, 30S ... 555S and other options (increasing 15S each time), press [ or ] key to the corresponding option, then press [] key to select; if you choose infinite, the screen displays transmit time close, if you select others, the screen display corresponding time selected.













CTC/DCS

CTCSS/DCS can only be set on analog mode, including:



















- CTCSS/DCS encoding
- CTCSS/DCS decoding

Encode

1. Press [] key to enter the menu mode.
2. Press [ or ] key to utilities, and then press [] key to select.
3. Press [ or ] key to program radio, and then press [] key to select.

4. Use the keypad to enter the correct Program radio password (programmed by software), and then press [] key to select.
5. Press [ or ] key to CTCSS/DCS, and then press [] key to select.
6. Press [ or ] key to CTCSS/DCS encoding, and then press [] key to select.
7. Screen display off and a set of CTCSS/DCS encoding value, press [ or ] key to off, and then press [] key to select, and there will be no CTCSS/DCS encoding value, screen displays CTCSS/DCS encoding value off; press [ or ] key to CTCSS/DCS encoding value, and then press [] key to select, then set the corresponding value, screen displays the corresponding CTCSS/DCS encoding value.















Decode

1. Press [] key to enter the menu mode.
2. Press [ or ] key to utilities, and then press [] key to select.
3. Press [ or ] key to program radio, and then press [] key to select.
4. Use the keypad to enter the correct Program radio password (programmed by software), and then press [] key to select.
5. Press [ or ] key to CTCSS/DCS, and then press [] key to select.
6. Press [ or ] key to CTCSS/DCS decoding, and then press [] key to select.
7. Screen display off and a set of CTCSS/DCS decoding value, press [ or ] key to off, and then press [] key to select, and there will be no CTCSS/DCS decoding value, screen displays CTCSS/DCS decoding value off; press [ or ] key to CTCSS/DCS

decoding value, and then press [] key to select, then set the corresponding value, screen displays the corresponding CTCSS/DCS decoding value.









Color Code

Color code only can be set on digital channels.



1. Press [] key to enter the menu mode.
2. Press [ or ] key to utilities, and then press [] key to select.
3. Press [ or ] key to program radio, and then press [] key to select.
4. Use the keypad to enter the correct Program radio password (programmed by software), and then press [] key to select.
5. Press [ or ] key to color code, then press [] key to select.
6. Press [ or ] key to select color code values, and then press [] key to select.
Screen shows X(the selected color code value) is selected.

Repeater Slot

Repeater slot only can be set on digital channels.

1. Press [] key to enter the menu mode.
2. Press [ or ] key to utilities, and then press [] key to select.
3. Press [ or ] key to program radio, and then press [] key to select.
4. Use the keypad to enter the correct Program radio password (programmed by software), and then press [] key to select.

5. Press [ or ] key to repeater slot, and then press [] key to select.

6. Press [ or ] key to select repeater slot values, and then press [] key to select.
Screen shows X(the selected repeater slot value) is selected.

Specifications

General Specifications

Frequency range	VHF: 136-174MHz	UHF: 400-480MHz
Channel	1000 Channels	
Channel Spacing	12.5KHz	
Operating Voltage	7.4V	
Battery Type	Li-ion	
Operating Temperature	-30℃ +60℃	
Store Temperature	-40℃ +85℃	
Antenna Impedence	50Ω	
Audio Output Power	≤ 1000mW@16Ω	
Battery capacity	2200mAh standard Li-ion battery	
Dimension (H*W*D)	131*61*36mm (Not Including Antenna)	
Weight	258g	

Transmitter

Output power	High: ≤ 5W (HI)	Low: ≤ 1W (Low)
Frequency Stability	±1.0PPM	
Adjacent Channel Power	≤ -60dB	
Free Time Slot Power	TDMA: ≤ 57dBm	
Hum and Noise	-40dB@12.5KHz	
Spurious Radiation	Antenna: 9KHz-1GHz	≤ -36dBm
	1GHz-12.75GHz	≤ -30dBm
FM Modulation Mode	12.5KHz: 11K0F3E	
4FSK Digital Mode	12.5KHz(data only):7K60FXD	
	12.5KHz(data +voice): 7K60FXE	
Modulation Maximum Deviation	2.5KHz@12.5KHz	
Nonactive Slot Power	-57dBm	
Digital Protocol	ETSI TS 102 361-1 -2 -3	
Vocoder Type	AMBE+2TM	
Audio Response	+1dB~-3dB	
Modulation BER(Bit Error Rate)	≤ 5%	

Receiver

Analog sensibility	0.35uV/-116dBm(20dB SINDA) 0.22uv/-120dBm(Type)
Digital sensibility	0.3uV/-117.4dBm (BER 5%) 0.7uv/-110dBm (BER 1%)
Co-channel Rejection	≥ -12dB
Adjacent Channel Selectivity	TIA603C:65dB ETSI:60dB
Spurious Response	TIA603C:75dB ETSI:70dB
Rated audio power	1W
Audio response	=1dB~-3dB
Rated audio distortion	3%(Type)
Spurious Radiation	Antenna: 9KHz-1GHz ≤ -57dBm 1GHz-12.75GHz ≤ -47dBm

Note: Specifications will be revised without notice due to technical improvement. Thank you.

Guarantee

Model Number: _____

Serial Number: _____

Purchasing Date: _____

Dealer: _____ Telephone: _____

User's Name: _____ Telephone: _____

Address: _____ Post Code: _____

Remarks:

- 1 This guarantee card to be kept by the user, no replenishment if lost.
- 2 This guarantee card to be filled & chopped by the dealer, or it is invalid.
- 3 Don't alter the guarantee card, please confirm the serial number on the guarantee card is same as that on the machine.
- 4 One-year guarantee, charger, battery, ear-phone, antenna and cable are not under guarantee.
- 5 The user can get repairing service from the followingways:
 - Go to the shop where you buy the machine.
 - Our local repairing agents.
 - Send back to our company.

Please cut along with this line

