

## IMPORTANT WARRANTY INFORMATION! PLEASE READ

**Return Policy on Kits When *Not* Purchased Directly From Vectronics:** Before continuing any further with your VEC kit check with your Dealer about their return policy. If your Dealer allows returns, your kit must be returned *before* you begin construction.

**Return Policy on Kits When Purchased Directly From Vectronics:** Your VEC kit may be returned to the factory *in its pre-assembled condition only*. The reason for this stipulation is, once you begin installing and soldering parts, you essentially take over the role of the device's manufacturer. From this point on, neither Vectronics nor its dealers can reasonably be held accountable for the quality or the outcome of your work. Because of this, Vectronics cannot accept return of any kit-in-progress or completed work as a warranty item for any reason whatsoever. If you are a new or inexperienced kit builder, we urge you to read the manual carefully and determine whether or not you're ready to take on the job. If you wish to change your mind and return your kit, you may--but you must do it *before* you begin construction, and within ten (10) working days of the time it arrives.

**Vectronics Warrants:** Your kit contains each item specified in the parts list.

**Missing Parts:** If you determine, during your pre-construction inventory, that any part is missing, please contact Vectronics and we'll send the missing item to you free of charge. However, *before* you contact Vectronics, *please look carefully* to confirm you haven't misread the marking on one of the other items provided with the kit. Also, make certain an alternative part hasn't been substituted for the item you're missing. If a specific part is no longer available, or if Engineering has determined that an alternative component is more suitable, Vectronics reserves the right to make substitutions at any time. In most cases, these changes will be clearly noted in an addendum to the manual.

**Defective Parts:** Today's electronic parts are physically and electrically resilient, and defective components are rare. However, if you discover an item during your pre-construction inventory that's obviously broken or unserviceable, we'll replace it. Just return the part to Vectronics at the address below accompanied with an explanation. Upon receipt, we'll test it. If it's defective and appears unused, we'll ship you a new one right away at no charge.

**Missing or Defective Parts After You Begin Assembly:** Parts and materials lost or damaged *after construction begins* are not covered under the terms of this warranty. However, most parts supplied with VEC kits are relatively inexpensive and Vectronics can replace them for a reasonable charge. Simply contact the factory with a complete description. We'll process your order quickly and get you back on track.

**Factory Repair After You Begin Assembly:** *Kits-in progress and completed kits are specifically excluded from coverage by the Vectronics warranty.* However, as a service to customers, technicians are available to evaluate and repair malfunctioning kits for a minimum service fee of \$18.00 (½ hour rate) plus \$7.00 shipping and handling (prices subject to change). To qualify for repair service, your kit must be fully completed, unmodified, and the printed circuit board assembled using rosin-core solder. In the event your repair will require more than an hour to fix (or \$36.00, subject to change), our technicians will contact you in advance by telephone before performing the work. Defective units should be shipped prepaid to:

Vectronics  
1007 HWY 25 South  
Starkville, MS 39759

When shipping, pack your kit well and include the minimum payment plus shipping and handling charges (\$25.00 total). No work can be performed without pre-payment. Also, provide a valid UPS return address and a day time phone number where you may be reached.

## **INTRODUCTION**

Whether you're a novice or seasoned "pro", you'll be pleasantly surprised at how these receivers perform! SSB, CW and AM signals from hams around the world are easily copied; their sensitivity rivals those receivers that cost many times more. Build the receiver for your favorite band. Eight tuning options allow you to customize the tuning range from full-band to 100-kHz or less. Use it on-the-go or at home with your home-brew or Vectronics QRP CW transmitter kit. Powered by a common 9-volt transistor battery, it's always ready for action on Field Day or camping trips!

## **TOOLS AND SUPPLIES**

**Construction Area:** Kit construction requires a clean, smooth, and well-lighted area where you can easily organize and handle small parts without losing them. An inexpensive sheet of white poster board makes an excellent construction surface and provides protection for the underlying table or desk. Well-diffused overhead lighting is a plus, and a supplemental high-intensity desk lamp is especially helpful for close-up work. Safety is always important! Be sure to use a suitable high-temperature stand for your soldering iron, and keep the work area free of combustible clutter.

**Universal Kit-building Tools:** Although your particular kit may require additional items for completion, virtually all construction projects require a work area outfitted with the following tools and supplies:

- 30 to 60 Watt Soldering Iron (grounded-tip and temperature-controlled preferred)
- High-temperature Iron Holder with Cleaning Sponge
- Rosin-core Solder (thin wire size preferred, .031")
- Needle Nose Pliers or Surgical Hemostats
- Diagonal Cutters or "Nippy Cutters"
- Solder Sucker (squeeze or vacuum pump type), or Desoldering Braid
- Bright Desk Lamp
- Magnifying Glass

**Special Tools for This Kit:**

- "Hex" tuning tool
- "Blade" type tuning tool or jeweler's screwdriver

## **BEFORE YOU START BUILDING:**

Experience shows there are *four common mistakes* builders make. Avoid these, and your kit will probably work on the first try! Here's what they are:

- 1. Installing the Wrong Part:** It always pays to double-check each step. A 1K and a 10K resistor may look *almost* the same, but they may act very differently in an electronic circuit! Same for capacitors--a device marked 102 (or .001 uF) may have very different operating characteristics from one marked 103 (or .01uF).
- 2. Installing Parts Backwards:** Always check the polarity of electrolytic capacitors to make sure the positive (+) lead goes in the (+) hole on the circuit board. Transistors have a flat side or emitter tab to help you identify the correct mounting position. ICs have a notch or dot at one end indicating the correct direction of insertion. Diodes have a banded end indicating correct polarity. Always double-check--especially before applying power to the circuit!
- 3. Faulty Solder Connections:** Inspect for cold solder joints and solder bridges. Cold solder joints happen when you don't fully heat the connection--or when metallic corrosion and oxide contaminate a component lead or pad. Solder bridges form when a trail of excess solder shorts pads or tracks together (see Soldering Tips below).
- 4. Omitting or Misreading a Part:** This is easier to do than you might think! Always double-check to make sure you completed each step in an assembly sequence.

### **Soldering Tips:**

*Cleanliness* and good *heat distribution* are the two secrets of professional soldering. Before you install and solder each part, inspect leads or pins for oxidation. If the metal surface is dull, sand with fine emery paper until shiny. Also, clean the oxidation and excess solder from the soldering iron tip to ensure maximum heat transfer. Also, clean the oxidation and excess solder from the soldering iron tip to ensure maximum heat transfer. Allow the tip of your iron to contact both the lead and pad for about one second (count "one-thousand-one") before feeding solder to the connection. Surfaces must become hot enough for solder to *flow smoothly*. Feed solder to the opposite side of the lead from your iron tip--solder will wick around the lead toward the tip, wetting all exposed surfaces. Apply solder sparingly, and do not touch solder directly to the hot iron tip to promote rapid melting.

### **Desoldering Tips:**

If you make a mistake and need to remove a part, follow these instructions carefully! First, grasp the component with a pair of hemostats or needle-nose pliers. Heat the pad beneath the lead you intend to extract, and pull gently. The lead should come out. Repeat for the other lead. Solder may fill in behind the lead as you extract it--especially if you are working on a double-sided board with plate-through holes. Should this happen, try heating the pad again and inserting a common pin into the hole. Solder won't stick to the pin's chromium plating. When the pad cools, remove the pin and insert the correct component. For ICs or multi-pin parts, use desoldering braid to remove excess solder before attempting to extract the part. Alternatively, a low-cost vacuum-bulb or spring-loaded solder sucker may be used. Parts damaged or severely overheated during extraction should be replaced rather than reinstalled.

### Work Habits:

Kit construction requires the ability to follow detailed instructions and, in many cases, to perform new and unfamiliar tasks. To avoid making needless mistakes, work for short periods when you're fresh and alert. Recreational construction projects are more informative and more fun when you take your time. Enjoy!

### Sorting and Reading Resistors:

The electrical value of resistors is indicated by a color code (shown below). You don't have to memorize this code to work with resistors, but you do need to understand how it works:

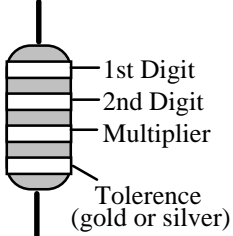
<b>Resistor Color Code</b>		
	Black = 0 (tens)	Blue = 6
	Brown = 1 (hundreds)	Violet = 7
	Red = 2 (K)	Gray = 8
	Orange = 3 (10K)	White = 9
	Yellow = 4 (100K)	Silver = 10%
	Green = 5 (1Meg)	Gold = 5%

When you look at a resistor, check its multiplier code first. Any resistor with a black multiplier band falls between 10 and 99 ohms in value. Brown designates a value between 100 and 999 ohms. Red indicates a value from 1000 to 9999 ohms, which is also expressed as 1.0K to 9.9K. An orange multiplier band designates 10K to 99K, etc. To sort and inventory resistors, first separate them into groups by multiplier band (make a pile of 10s, 100s, Ks, 10Ks, etc.). Next, sort each group by specific value (1K, 2.2K, 4.7K, etc.). This procedure makes the inventory easier, and also makes locating specific parts more convenient later.

on during construction. Some builders find it especially helpful to arrange resistors in ascending order along a strip of double-sided tape.

Some VEC kits may contain molded chokes which appear, at first glance, similar to resistors in both shape and band marking. However, a closer look will enable you to differentiate between the two--chokes are generally larger in diameter and fatter at the ends than resistors. When doing your inventory, separate out any chokes and consult the parts list for specific color-code information.

**Reading Capacitors:**

Unlike resistors, capacitors no longer use a color code for value identification. Instead, the value, or a 3-number code, is printed on the body.

Value	Code	Multilayer (270 pF)	Ceramic Discs (.001 uF) (.1 uF)	Electrolytic 1 uF
10 pF	= 100			
100 pF	= 101			
1000 pF	= 102			
.001 uF	= 102*	271	102	
.01 uF	= 103		104	
.1 uF	= 104			

As with resistors, it's helpful to sort capacitors by type, and then to arrange them in ascending order of value. Small-value capacitors are characterized in pF (or pico-Farads), while larger values are labeled in uF (or micro-Farads). The transition from pF to uF occurs at 1000 pF (or .001 uF)\*. Today, most monolithic and disc-ceramic capacitors are marked with a three-number code. The first two digits indicate a numerical value, while the last digit indicates a multiplier (same as resistors).

Electrolytic capacitors are always marked in uF. Electrolytics are polarized devices and must be oriented correctly during installation. If you become confused by markings on the case, remember the uncut negative lead is slightly shorter than the positive lead.

**Diodes:**

Diodes are also polarized devices that must be installed correctly. Always look for the banded or cathode end when installing, and follow instructions carefully.

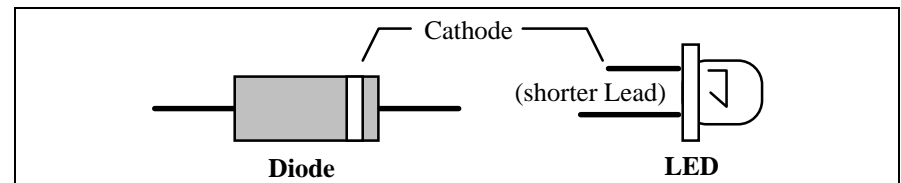

**Transistors:**

If transistors are installed incorrectly, damage may result when power is applied. Transistors in metal cases have a small tab near the emitter lead to identify correct positioning. Semiconductors housed in small plastic cases (TO-92) have an easily-identified flat side to identify mounting orientation. Many specialized diodes and low-current voltage regulators also use this type packaging. Larger plastic transistors and voltage regulators use a case backed with a prominent metal tab to dissipate heat (T-220). Here orientation is indicated by the positioning of the cooling tab.

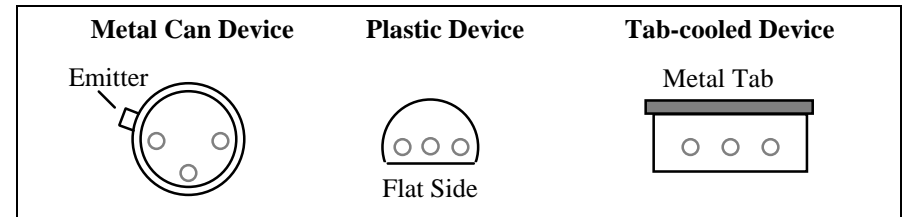
**Integrated Circuits:**

Proper IC positioning is indicated by a dot or square marking located on one end of the device. A corresponding mark will be silk-screened on the PC board and printed on the kit's parts-placement diagram. To identify specific IC pin numbers for testing purposes, see the diagram below. Pin numbers always start at the keyed end of the case and progress counter-clockwise around the device, as shown in the following diagram.

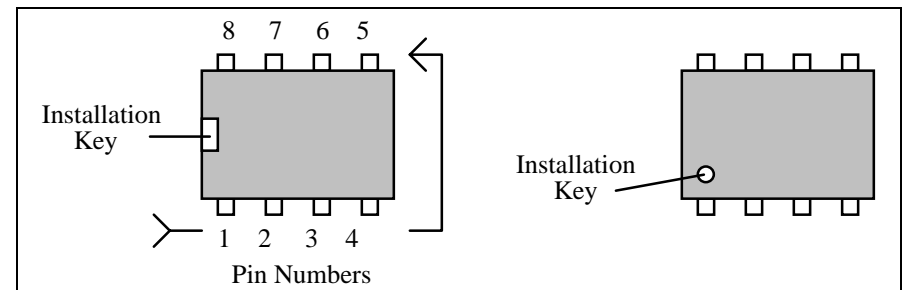
**PARTS LIST**

Your kit should contain all of the parts listed below. Please identify and inventory each item on the checklist before you start building. If any parts are missing or damaged, refer to the manual's warranty section for replacement instructions. If you can't positively identify an unfamiliar item on the basis of the information given, set it aside until all other items are checked off. You may

then be able to identify it by process of elimination. Finally, your kit will go together more smoothly if parts are organized by type and arranged by value ahead of time. Use this inventory as an opportunity to sort and arrange parts so you can identify and find them quickly.

**Note:** There should be three parts bags in your kit. Two bags contain parts that are common to all of the direct conversion kits. The third parts bag contains those components that are unique to the VEC-1180, VEC-1140, VEC-1130 and VEC-1120. Please proceed to the model number heading that corresponds to your kit and inventory those parts. *Note: only the first three color bands are given for the molded chokes. The fourth band is the tolerance band, and may be either gold or silver.* The following parts are packaged separately:

**VEC-1180 75-80 meter direct conversion receiver:**

<input checked="" type="checkbox"/>	Qty	Part Description
<input type="checkbox"/>	1	3.3 uH molded choke (orange-orange-gold)
<input type="checkbox"/>	1	33 uH molded choke (orange-orange-black)
<input type="checkbox"/>	1	6.8 uH variable inductor, shielded
<input type="checkbox"/>	2	470 monolithic (471)

**VEC-1140 40-meter direct conversion receiver:**

<input checked="" type="checkbox"/>	Qty	Part Description
<input type="checkbox"/>	1	1 uH molded choke (brown-black-gold)
<input type="checkbox"/>	1	10 uH molded choke (brown-black-black)
<input type="checkbox"/>	1	1.5 uH variable inductor, shielded
<input type="checkbox"/>	1	470 pF monolithic (471)
<input type="checkbox"/>	1	680 pF monolithic (681)

**VEC-1130 30-meter direct conversion receiver:**

<input checked="" type="checkbox"/>	Qty	Part Description
<input type="checkbox"/>	1	.47 uH molded choke (yellow-violet-silver)
<input type="checkbox"/>	1	4.7 uH molded choke (yellow-violet-gold)
<input type="checkbox"/>	1	1.5 uH variable inductor, shielded
<input type="checkbox"/>	1	330 pF monolithic (331)
<input type="checkbox"/>	1	680 pF monolithic (681)



**VEC-1120 20-meter direct conversion receiver:**

<input checked="" type="checkbox"/>	Qty	Part Description
<input type="checkbox"/>	1	.22 uH molded choke (red-red-silver)
<input type="checkbox"/>	1	2.2 uH molded choke (red-red-gold)
<input type="checkbox"/>	1	.211 uH variable inductor, green coil form
<input type="checkbox"/>	3	470 pF monolithic (471)

The following list of parts is common to all models of the Vectronics direct conversion receiver and should be included in your kit. Please inventory the following parts:

**Capacitors:**

<input checked="" type="checkbox"/>	Qty	Part Description	Designation
<input type="checkbox"/>	1	8.2 pF ceramic disc (8.2)	C1
<input type="checkbox"/>	1	100 pF ceramic trimmer capacitor	C18
<input type="checkbox"/>	1	variable capacitor	C19,A,B,C,D
<input type="checkbox"/>	6	.1 uF monolithic (.1 or 104)	C2,6,7,8,9,10
<input type="checkbox"/>	1	.01 uF ceramic disc (.01 or 103)	C20
<input type="checkbox"/>	3	1 uF electrolytic	C12,13,14
<input type="checkbox"/>	2	470 uF electrolytic	C16,17
<input type="checkbox"/>	2	10 uF electrolytic	C11,15

**Fixed Resistors:**

<input checked="" type="checkbox"/>	Qty	Part Description	Designation
<input type="checkbox"/>	1	15 ohm (brown, green, black)	R2
<input type="checkbox"/>	1	100 ohm (brown, black, brown)	R38

**Variable Resistors:**

<input checked="" type="checkbox"/>	Qty	Part Description	Designation
<input type="checkbox"/>	1	1000 ohm variable potentiometer	R1

**Semiconductors:**

<input checked="" type="checkbox"/>	Qty	Part Description	Designation
-------------------------------------	-----	------------------	-------------

<input type="checkbox"/>	1	LM386 audio amplifier, 8-pin DIP	U3
<input type="checkbox"/>	1	LM602 linear RF IC, 8-pin DIP	U1
<input type="checkbox"/>	1	78L05 voltage regulator	U2

**Connectors:**

<input checked="" type="checkbox"/>	Qty	Part Description	Designation
<input type="checkbox"/>	1	RCA jack, ANT connector, pc mount	J1
<input type="checkbox"/>	1	1/4 earphone/speaker jack, pc mount	J2

**Miscellaneous:**

<input checked="" type="checkbox"/>	Qty	Part Description	Designation
<input type="checkbox"/>	2	IC sockets, 8-pin DIP	
<input type="checkbox"/>	1	shaft, tuning extension	
<input type="checkbox"/>	1	DPDT push-action power switch	SW1
<input type="checkbox"/>	1	battery clip with leads	
<input type="checkbox"/>	1	cable tie-wrap, nylon	
<input type="checkbox"/>	1	PC board, etched, drilled and masked	
<input type="checkbox"/>	2	6" insulated 24-gauge stranded wire	
<input type="checkbox"/>	1	double-sided tape	

### PARTS PLACEMENT DIAGRAM

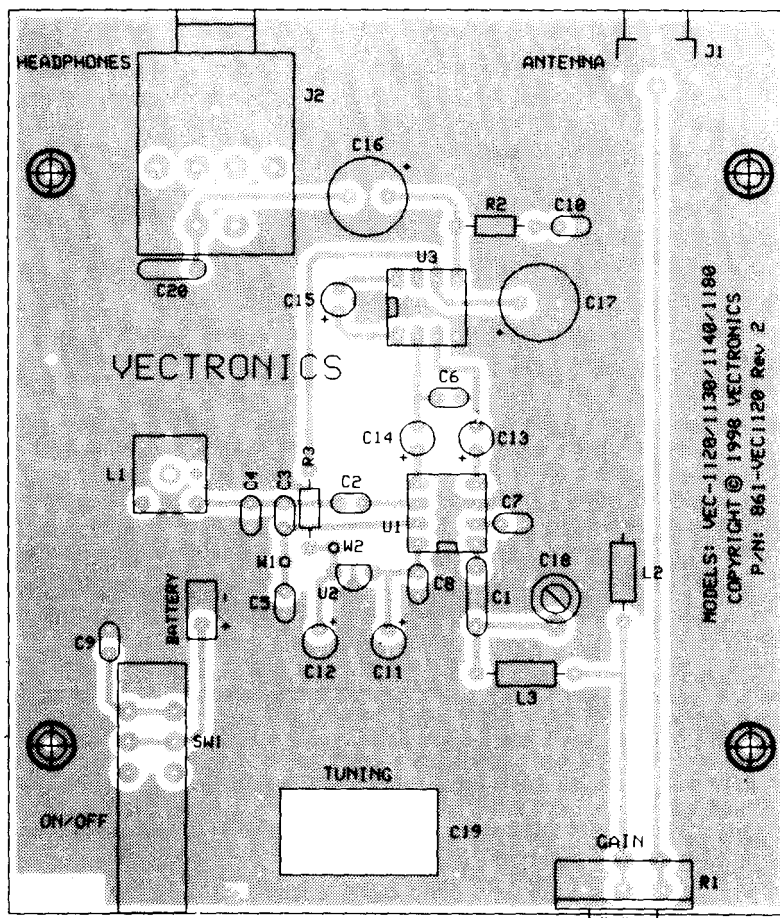

## **STEP-BY-STEP ASSEMBLY INSTRUCTIONS**

Before assembling your kit, please take time to read and understand the VEC kit warranty printed on the inside cover of this manual. Read through the assembly instructions to make sure the kit does not exceed your skill level. Once construction is started, the kit is *non-returnable*. Finally, if you haven't already done so, please verify that all parts listed in the inventory are included. If anything is missing or broken, refer to the warranty instructions for replacing missing or damaged parts.

First, a few notes and comments to help you along. Part designators for components such as R1, C3, etc., appear on the silk-screened legend on the component-mounting side of the printed circuit board. These correspond to the drawing shown in the section "PARTS PLACEMENT DIAGRAM". The parts are inserted on the silk-screen side of the board. All capacitors should be installed with their bodies as close to the PC board as possible; this is very important in RF circuits.

**Important Note:** A monolithic cap is similar to a surface-mount "chip" capacitor, except that it has a lead spot-welded onto each end of the capacitor body. Monolithics have superior radio-frequency operating characteristics, but the lead welds *may* fail if the device is over-stressed during installation or removal. For this reason, *never use force to seat a monolithic cap* into the PC board. If the spacing isn't right, pre-form the leads to the correct spacing before installation!

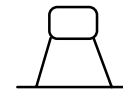

**Incorrect**

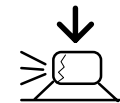

**Oops!**



**Correct**

If you have last-minute questions concerning what tools or materials are needed to assemble this kit, please refer back to the section entitled "BEFORE YOU BEGIN".

**“Install”** In these instructions, when you are directed to *install* a part, this means to locate, identify, and insert the part into its mounting holes on the PC board. This includes pre-bending or straightening leads as needed so force is not required to seat the part. Once a component is mounted, bend each lead over to hold it in place. Use sharp side-cutters to clip off excess lead length before soldering. Make sure trimmed leads don't touch other pads and tracks, or a short circuit may result:

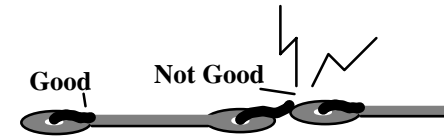

**“Solder”** When you are directed to *solder*, this means to solder the part’s leads in place, and to inspect both (or all) solder connections for flaws or solder bridges. If no soldering problems are noted, nip off the excess protruding leads with a sharp pair of side cutters.

We will begin by installing those parts that are unique to the particular model receiver you are constructing. Proceed to the directions that are associated with your kit’s model number.

**VEC-1180K 80-75-Meter Receiver:**

- 1. *Install* the 3.3-uH molded-choke (orange-orange-gold) at the L2 location designated by the silk-screened legend on the PC board. *Solder.*
- 2. Install and solder the 33-uH choke (orange-orange-black) at location L3.
- 3. Install and solder one of the 470-pF monolithic capacitors (471) at location C3.
- 4. Install and solder the remaining 470-pF monolithic (471) at location C5.

**Important Note:** Capacitor C4 is *not* used in the 80-meter receiver.

- 5. Locate the 6.8-uH tunable-inductor. Note this part has five coil leads, and two shield tabs to be inserted and soldered.
- 6. At location L1, align the coil leads to match the hole pattern and insert coil L1.
- 7. While ensuring the can remains fully seated and standing vertical, bend over the two shield tabs flush to the PC board foil and solder.
- 8. Solder the five coil leads.
- 9. Check that all parts are correctly installed in the proper locations.

This completes the installation of parts unique to the 80-meter receiver. Proceed to the section titled "GENERAL ASSEMBLY".

**VEC-1140K 40-Meter Receiver:**

- 1. *Install* the 1.0-uH molded-choke (brown-black-gold) at the L2 location designated by the silk-screened legend on the PC board. *Solder.*
- 2. Install and solder the 10-uH choke (brown-black-black) at location L3.
- 3. Install and solder the 470-pF monolithic capacitor (471) at location C3.
- 4. Install and solder the 680-pF monolithic (471) at location C5.

**Important Note:** Capacitor C4 is *not* used in the 40-meter receiver.

- 5. Locate the 1.5-uH tunable-inductor. Note this part has five coil leads, and two shield tabs to be inserted and soldered.
- 6. At location L1, align the coil leads to match the hole pattern and insert coil L1.
- 7. While ensuring the can remains fully seated and standing vertical, bend over the two shield tabs flush to the pc board foil and solder.
- 8. Solder the five coil leads.

This completes the installation of parts unique to the 40-meter receiver. Proceed to the section titled "GENERAL ASSEMBLY".

**VEC-1130K 30-Meter Receiver:**

- 1. *Install* the .47-uH molded-choke (yellow-violet-silver) at the L2 location designated by the silk-screened legend on the PC board. *Solder.*
- 2. Install and solder the 4.7-uH choke (yellow-violet-gold) at location L3.
- 3. Install and solder the 330-pF monolithic capacitor (331) at location C3.
- 4. Install and solder the 680-pF monolithic (681) at location C5.

**Important Note:** Capacitor C4 is *not* used in the 30-meter receiver.

- 5. Locate the 1.5-uH tunable-inductor. Note this part has five coil leads, and two shield tabs to be inserted and soldered.
- 6. At location L1, align the coil leads to match the hole pattern and insert coil L1.
- 7. While ensuring the can remains fully seated and standing vertical, bend over the two shield tabs flush to the pc board foil and solder.

- 8. Solder the five coil leads.

This completes the installation of parts unique to the 30-meter receiver. Proceed to the section titled "GENERAL ASSEMBLY".

#### **VEC-1120K 20-Meter Receiver:**

- 1. *Install* the .22-uH molded-choke (red-red-silver) at the L2 location designated by the silk-screened legend on the pc board. *Solder*.
- 2. Install and solder the 2.2-uH choke (red-red-gold) at location L3.
- 3. Install and solder one of the 470-pF monolithic capacitors (471) at location C3.
- 4. Install and solder a 470-pF monolithic capacitor (471) at C4.
- 5. Install and solder the remaining 470-pF monolithic (471) at location C5.

**Important Note:** Capacitor C4 is *not* used in the 80-meter receiver.

- 6. Locate the .211-uH tunable-inductor (green coil form).
- 7. At location L1, align the coil leads to match the hole pattern and insert coil L1.

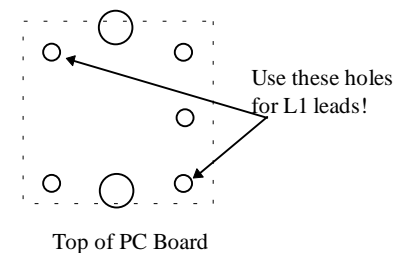

- 8. While ensuring the coil remains fully seated and standing vertical, solder the coil leads.

This completes the installation of parts unique to the 20-meter receiver. Proceed to the section titled "GENERAL ASSEMBLY".

### **GENERAL ASSEMBLY**

#### **Resistor Installation:**

- 1. Begin assembly by installing the ¼-watt fixed resistors. Because these are all 5-percent tolerance ending with a fourth *gold* color band, you

need only read the first three bands of the color code during the following steps. All resistor leads should be formed as shown below. Install and solder resistors at the following locations:

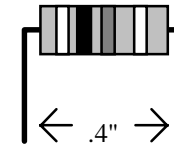

- 2. R2 15-ohm (brown-green-black)
- 3. R3 100-ohm (brown-black-brown)
- 4. Check that all resistor locations on the PC board are occupied by the correct value resistor.
- 5. Check each solder joint. Look for solder splashes, bridges (a *bridge* is where solder has made a connection between two or more points that should not be connected), or poor solder connections.

#### Capacitor Installation:

- 1. Find the 8.2-pF ceramic disc capacitor (8.2). Install and solder at location C1.
- 2. Find the six .1-uF monolithic capacitors (.1 or 104). Install and solder at the six following locations:
  - 3. C2 .1-uF (104 or .1)
  - 4. C6 .1-uF (104 or .1)
  - 5. C7 .1-uF (104 or .1)
  - 6. C8 .1-uF (104 or .1)
  - 7. C9 .1-uF (104 or .1)
  - 8. C10 .1- uF (104 or .1)
- 9. Find the .01-uF ceramic disc capacitor (103 or .01). Install and solder at location C20.
- 10. Locate the 100-pF ceramic trimmer capacitor. Insert and solder at location C18.

#### IC Installation:

- 1. Locate 2 (two) 8-pin IC sockets. These are “low-profile” style sockets which are suitable for use at radio frequencies. Note that the sockets are *keyed* to indicate pins 1 and 8. The key is either a “U” or



rectangular shaped notch. The silk-screen legend on the PC board will indicate proper orientation. Inspect each socket carefully, and straighten any bent pins before attempting to installation.

**Important Note:** If you do not wish to use sockets with your kit, you may omit them and mount the ICs directly into the board (an option experienced builders may prefer). Sockets make IC removal easier in the event of an installation error or component failure. If you elect to omit the sockets, mount the ICs with their keys aligned as shown on the PC board.

- 2. Install and solder the IC sockets at the locations shown below:
- 3. U1 (notch towards C8)
- 4. U3 (notch towards C15)
- 5. Locate the NE602 (NE612 may be substituted in some kits), and the LM386 8-pin ICs.

The IC body has a small notch, or *key*, molded at one end, indicating pins 1 and 8. A small dimple-like body-molding is often found adjacent to pin 1. Some IC packages may include both key indicators.

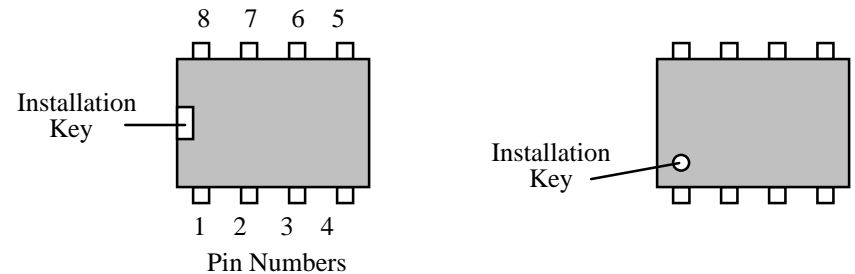

- 6. Align the body of the NE602 to correspond with the key of socket U1. Loosely insert the NE602 pins into socket U1. All 8 pins should fit freely into the socket openings. If not, straighten the IC pins until they do. Using firm and steady pressure, fully seat the IC into the socket. The socket and IC keys both face capacitor C8.
- 7. In a similar manner, install the LM386 into socket U3. The notches should face towards capacitor C15.
- 8. Locate the 78L05 voltage regulator IC.

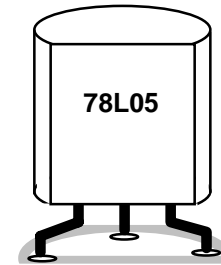

- 9. Install the 78L05 so its body is keyed to the silk-screen outline for IC U2. Re-form U2's leads as needed so it sits close to the board. Solder.

#### Installation of Electrolytic Capacitors:

Electrolytic capacitors are *polarized* devices, and must be inserted with respect to polarity. The style used in the VEC direct conversion receivers have *radial* leads; both leads exit from one end of the device body. Each capacitor's plus (+) mounting holes are noted both on the circuit board and parts placement diagram. If the markings on the capacitor body are unclear, the plus (+) lead is always the longer of the two.

- 1. Find the two 470-uF electrolytic capacitors. Install and solder at the following locations (*observe polarity*):
  - 2. C16 470 uF
  - 3. C17 470 uF
- 4. Find the two 10-uF electrolytic capacitors. Install and solder at the following locations (*observe polarity*):
  - 5. C11 10 uF
  - 6. C15 10 uF
- 7. Find the three 1-uF electrolytic capacitors. Install and solder at the following locations (*observe polarity*):
  - 8. C12 1 uF
  - 9. C13 1 uF
  - 10. C14 1 uF

#### Miscellaneous:

- 1. Install the 9-volt battery snap clip. Insert the red lead at +9V and the black lead at GND. Solder and trim.

- □ 2. Stress relief is provided to prevent battery leads from flexing and eventually breaking at their connection point. Find a hole part-way back on the left edge of the PC board (near SW1). Use the plastic tie-wrap provided in your kit to secure the battery leads in place, as shown below. Insert the tie-wrap through the hole, close it over the wires, and pull tight. Nip off the excess end.

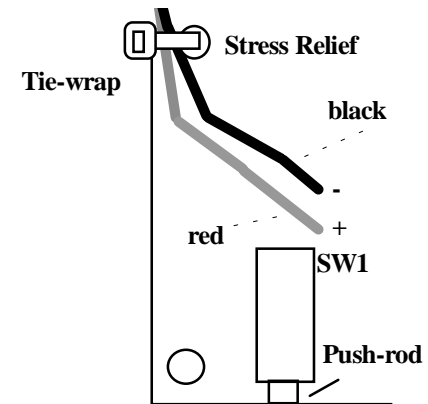

- □ 3. Locate the push-action DPDT power switch. Install at SW1, positioning so the push-rod faces the board edge (see above). While holding the switch body flush against the board, solder and trim the six switch pins.
- □ 4. The gain control is mounted next. Before installing, inspect the 1000-ohm potentiometer supplied with your kit. If the pins are located on the *front* side of the pot, use the *front set of mounting holes* on the PC board for installation. If the pins are on the *rear*, use the *rear set of mounting holes* (see below). Also, using side cutters, remove the key tab from the side of each pot prior to installation.

**Rear pins use rear holes.**

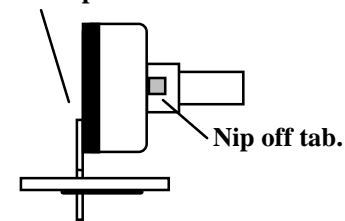

**Front pins use front holes.**

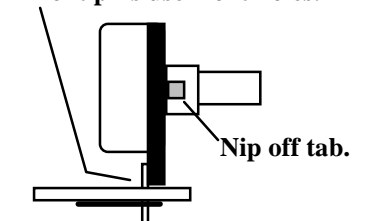

- □ 5. Locate the 1/4" earphone jack, install at J2. The jack opening faces the board edge. Solder all jack connections.

- 6. Locate the RCA jack. Install at J1, making sure it is fully seated and level before soldering in place.
- 7. Find the double-sided adhesive tape. Remove one of the protective covers to prepare for installation.
- 8. Locate the mounting location for main tuning capacitor C19.
- 9. Firmly press the double-sided tape over the silk-screened outline for the body of C19.
- 10. Locate main-tuning capacitor C19.
- 11. At the rear of the capacitor: locate the four internal trimmer capacitors, and using a small jeweler's screwdriver or alignment tool, fully open (unmesh) all four trimmers.
- 12. Remove the protective cover from the double-sided tape, and firmly press the body of capacitor C19 to mount it to the pc board. *Observe the drawing below for proper orientation:*

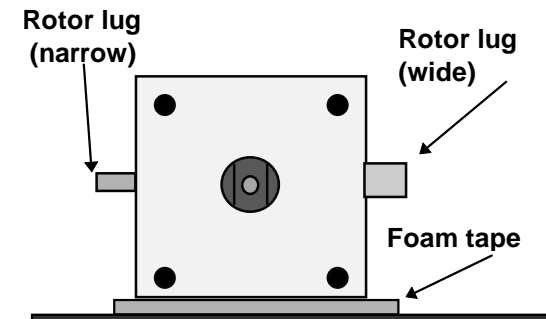

**Important Note:** tuning shaft faces front of board.

- 13. Bend the two rotor lugs so they are parallel to the front face of the capacitor as shown above.
- 14. Connect the two rotor lugs to the pc board ground points as shown below using scraps of lead wire trimmed from resistors as jumper wires:

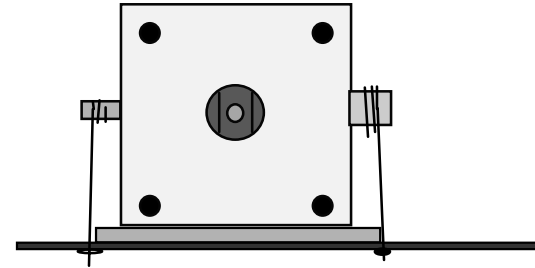

- 15. Solder the jumpers to the capacitor rotor lugs, and to the ground foil run on the bottom of the PC board.
- 16. Cut a 6" length of 24-AWG insulated hook-up wire in half.
- 17. Remove about 1/4" of the insulation from each of the cut ends.
- 18. Insert one end of a 3" insulated wire into the silk-screened location for W1. Free end of the insulated wire will be connected during the alignment procedures.
- 19. Insert the other 3" insulated wire into the silk-screened location for W2.
- 20. Connect the free end of the second insulated wire to one of the rear upper set of switch contacts on SW1. Solder.

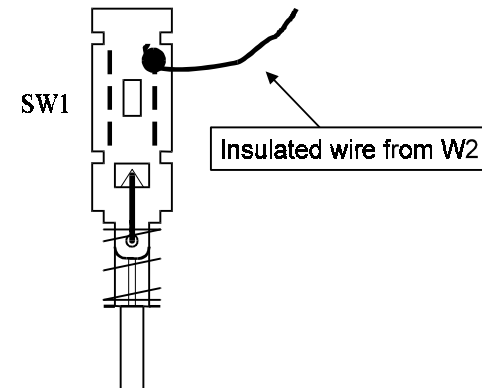

- 21. Find the tuning shaft extension. Screw into the main tuning capacitor shaft. Back off about two turns to open a gap between the two shafts. Allow a small drop of contact cement to flow into gap and onto

threads. Immediately screw shafts together until snug and allow glue to set. (Do not over-tighten or threaded portion of the shaft extension will break!)

**Important Note:** To perform alignment and tests, you will need knobs on the control shafts for the tuning capacitor and gain control. These knobs *are not* included in your direct conversion receiver kit. However, Vectronics makes a customized enclosure for your kit (VEC-1100KC), which includes knobs.

- 22. Install knobs on the shafts of the Gain control R1 and Tuning capacitor C19.
- 23. Set tuning capacitor C19 fully clockwise, and tighten the knob set screw with the knob indicator at the 9 o'clock position.
- 24. Set the gain control fully counter clockwise, and tighten the knob set screw with the knob indicator at the 7 o'clock position.

Your kit is finished, and it's time to take a well-earned break! When you come back, be sure to give your work a close "quality control" (QC) inspection before moving on.

**QC Inspection:**

- 1. All board locations should have components installed.

*Note: capacitor C4 is only used in the VEC-1120.*

- 2. Check all solder connections, looking for unwanted solder bridges or solder "splashes". Shine a bright light on the solder-side of the PC board, and keep a sharp eye for dull or poorly flowed solder joints. If the solder has adhered to the component leads, it will form a shiny "cone"; a "donut" like solder connection may indicate a poor connection.
- 3. Resolder solder joints that look suspect.
- 4. Watch for parts installed in the wrong spot! These errors must be corrected before attempting to align or use the kit.

Now that assembly and inspection is completed, you're ready to begin the testing and alignment phase of construction.

## **ALIGNMENT**

The receiver tuning capacitor may need to have jumpers installed to allow tuning over wider sections of the band you wish your receiver to cover. Several options are shown in the tables below. Chose the maximum tuning range that best meets your needs, and connect the free end of the insulated wire from W1 to the appropriate value tuning capacitor section (see drawing below):

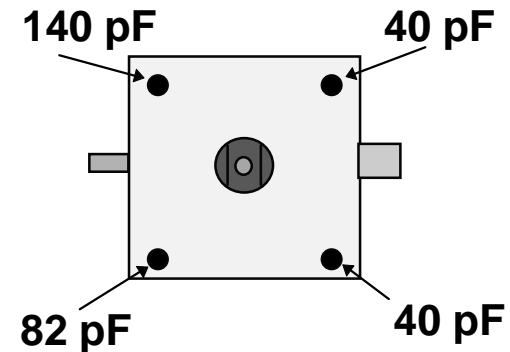

Greater tuning ranges can be had by paralleling two or more capacitor sections. Leads cut from resistors or capacitors will do for jumper wires for paralleling capacitor sections. For example, paralleling the 140 and 82-pF sections will give 222-pF of tuning capacitance, combining the 40 and 140-pF sections will give a 180-pF tuning capacitance. The table below shows several suggested capacitor combinations. However, too a large tuning range makes precise tuning of CW or SSB stations difficult. Use a larger-sized tuning knob to improve tuning resolution problems.

<b>Capacitor jumpers:</b>	
<b>180 pF</b>	<b>= use 140-pF and 40-pF sections paralleled</b>
<b>222 pF</b>	<b>= use 140-pF and 82-pF sections paralleled</b>
<b>262 pF</b>	<b>= use 140-pF, 82-pF and a 40-pF section paralleled</b>
<b>302 pF</b>	<b>= use all four capacitor sections in parallel</b>

**Important Note:** 80 and 75 meters are usually considered to be different bands. Most CW and RTTY activity takes place below 3.7 MHz, SSB and AM activity is between 3.7 and 4.0 MHz.

<b>VEC1180 tuning:</b>	
302pF	350 kHz
262pF	310 kHz
222pF	270 kHz
180pF	230 kHz
140pF	190 kHz
82pF	110 kHz
40pF	55 kHz

<b>VEC1140 tuning:</b>	
302pF	N/A
262pF	N/A
222pF	N/A
180pF	310 kHz
140pF	250 kHz
82pF	150 kHz
40pF	75 kHz

<b>VEC1130 tuning:</b>	
302pF	N/A
262pF	N/A
222pF	N/A
180pF	N/A
140pF	N/A
82pF	N/A
40pF	85 kHz

<b>VEC1120 tuning:</b>	
302pF	N/A
262pF	420 kHz
222pF	300kHz
180pF	420 kHz
140pF	300 kHz
82pF	170 kHz
40pF	90 kHz

N/A: Exceeds needed tuning range for Amateur Band limits.



**Local Oscillator Alignment:**

There are several methods for aligning the local oscillator portion of the receiver. Use the method that is easiest for you.

Using a receiver:

1. Place the VEC-11xx direct conversion receiver next to an Amateur or general coverage receiver that covers the band of interest. Connect a short 3 or 4 foot wire antenna to the receiver, route the antenna wire so it passes near the direct conversion receiver PC board.
2. Select a tuning tool that properly fits coil L1. The 20 meter kit requires a hex type alignment tool. The other kits require a small blade type tool that matches the slot in the coil core, or use a small jeweler's screwdriver.
3. Set coil L1 tuning core to the top of the coil form.
4. Tune the receiver to the lowest operating frequency by turning the tuning capacitor shaft fully CCW (counter clockwise).
5. Set the monitor receiver to the lowest frequency you wish to receive on the direct conversion receiver. The receiver should be set to a wide filter bandwidth, and if it has a BFO, it should be on.
6. Install a fresh 9-volt alkaline battery to the receiver, and turn it on by depressing the push-action power switch.
7. Carefully adjust the core in coil L1 until it is heard sweeping across the monitor receiver frequency. Set the coil for zero beat, or strongest S-meter reading on the receiver. Note that metal alignment tools will cause some frequency shift, and interact with the tuning when removed or inserted into the coil. You will have to adjust the coil in small increments, and observe the point where the proper frequency is reached when the tool is removed.

**Important Note:** Allow at least a 10-kHz tuning overlap on the band edges to compensate for aging and long-term drifting.

Using a signal generator:

1. Set the signal generator to the direct conversion receiver's lowest operating frequency. Set the generator output level for a 30-uV CW signal.
2. Connect the generator RF output to the VEC direct conversion antenna jack (J1) using coax cable and the appropriate mating connectors or adapters.

- 3. Connect a speaker or headphones to jack J2 on the receiver.
- 4. Set the receiver gain fully CW (clockwise) and the tuning knob fully CCW (counter clockwise).
- 5. Select a tuning tool that properly fits coil L1. The 20 meter kit requires a hex type alignment tool. The other kits require a small blade type tool that matches the slot in the coil core. Or, a jeweler's screwdriver may be used.
- 6. Set coil L1 tuning core to the top of the coil form.
- 7. Connect a fresh 9-volt alkaline battery to the receiver, and turn it on using the push-action power switch.
- 8. Carefully adjust the core in coil L1 until the generator signal is heard. Set the coil for zero beat. Note that metal alignment tools will cause some frequency shift, and interact with the tuning when removed or inserted into the coil. You will have to adjust the coil in small increments, and observe the point where the proper frequency is reached when the tool is removed.

**Important Note:** Allow at least a 10-kHz tuning overlap on the band edges to compensate for aging and long-term drifting.

Using a companion QRP transmitter:

- 1. Connect the QRP transmitter to a dummy load. The QRP transmitter should be located near the VEC-11xx direct conversion receiver.
- 2. Connect a speaker or headphones to jack J2 on the receiver.
- 3. Set the receiver gain fully CW (clockwise) and the tuning knob to a dial position that corresponds to the transmitter frequency.
- 4. Select a tuning tool that properly fits coil L1. The 20 meter kit requires a hex type alignment tool. The other kits require a small blade type tool that matches the slot in the coil core, or use a small jeweler's screwdriver.
- 5. Set coil L1 tuning core to the top of the coil form.
- 6. Connect a fresh 9-volt alkaline battery to the receiver, and turn it on using the push-action power switch.
- 7. Key the QRP transmitter so it is producing a carrier.
- 8. Carefully adjust the core in coil L1 until the QRP transmitter signal is heard. Set the coil for zero beat. Note that metal alignment tools will cause some frequency shift, and interact with the tuning when removed

or inserted into the coil. You will have to adjust the coil in small increments, and observe the point where the proper frequency is reached when the tool is removed.

## **FINAL ALIGNMENT**

Once the tuning range is set, the RF input stage must be peaked for best sensitivity. This can be done using a signal generator, or on-the-air signals.

Find an alignment tool or jeweler's screwdriver that fits trimmer capacitor C18.

Use one of the following three methods to peak C18.

- 1. Using a signal generator, peak C18 for best sensitivity. Reduce the signal generator output, or reduce the R1 Gain control setting, to prevent overload as C18 is brought into resonance.
- 2. Using off-air signals, adjust C18 until signals are loudest. Reduce the R1 Gain control as C18 is brought into resonance to prevent overload. Verify that C18 is properly peaked while monitoring a known on-air signal.
- 3. With an outside antenna connected, peak C18 for maximum atmospheric noise in the headphones or speaker. Verify that C18 is properly peaked while monitoring a known on-air signal.

## **OPERATING INSTRUCTIONS**

The Vectronics direct conversion receiver can be installed in a variety of enclosures of your own design or choosing. Radio Shack offers many inexpensive and attractive cases that may be adapted for this purpose. You might consider selecting a case roomy enough to house an internal speaker, or larger battery pack.

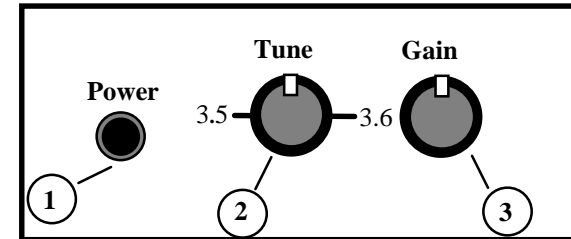

1. **POWER:** Push-on/push-off switch turns unit on and off.
2. **TUNE:** Sets the receiver to the desired frequency.
3. **GAIN:** Sets the volume level of the received signal to a comfortable level.

Using your direct conversion receiver is as simple as connecting a battery, headphones or speaker, and antenna to the receiver.

**Battery requirements:** Use an alkaline battery, such as the DuraCell™ MN1604. Alkaline batteries are more expensive initially, but are more economical in the long run.

**Tuning CW stations:** Tune across the band until a CW signal is heard. Gain control R1 should be set for a comfortable listening level. Carefully adjust the tuning until the “beat note”, or tone, suits your tastes. Most experienced CW operators prefer a lower beat note of about 300 or 400 Hz.

**Tuning SSB stations:** It may take a little practice to tune a Single-Side Band signal properly. Direct conversion receivers offer no upper or lower sideband rejection; slowly tune across the SSB signal until the voices become natural sounding. Use the gain control to prevent overload and to set a comfortable listening level.

**Tuning AM stations:** Unlike SSB signals, AM signals have a carrier frequency- you will hear a beat note as you tune across an AM signal. Tune the signal so the beat note becomes lower in frequency and stop when “zero beat” (beat note disappears) is reached.

**Antenna requirements:** Direct conversion receivers need good antennas. Using a random length of wire will give poor results. Half-wave dipoles are

simple to make, and are very effective antennas. For QRP work, or for receive only applications, low-cost RG-58 52-ohm coax is fine. CATV 75-ohm cable, such as RG-59, will also work well.

The formula:

$$234/(\text{frequency in MHz}) = 1/4\text{-wavelength in feet}$$

will give the length of wire needed for each leg of the dipole. For example, a 30-meter dipole cut for 10.120 MHz would use two wire legs, each about 23.12 feet in length.

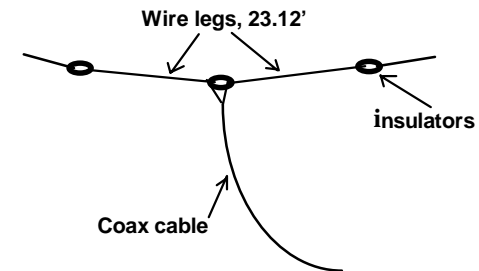

**30-meter dipole**

An alternative antenna for 80, 75 and 40 meters is a 1/4-wave wire antenna. The wire antenna is connected directly to the receiver. For best results, a good ground is needed when using a wire antenna.

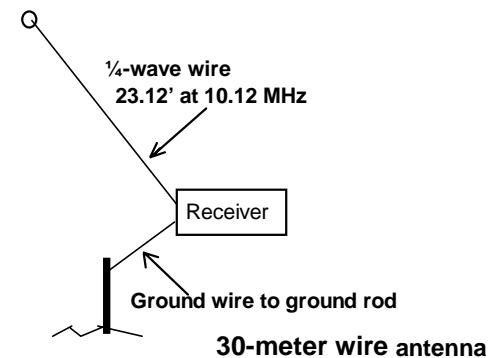

**30-meter wire antenna**

**Overload and SW station bleed through:** An unfortunate fact of life is that low-power Amateur signals are surrounded by high-power SW broadcast signals.

For example, the 30-meter Amateur band is boxed by the 25 and 31 meter SW broadcast bands. Direct conversion receivers are very simple devices, and by nature are easily overloaded. There are several things you can try if strong SW stations are overloading the receiver and “breaking through”.

1. **Use the gain control.** Simply lowering the gain setting will resolve many overload problems.
2. **Use a preselector.** A receiver preselector provides protection from strong out-of-band signals. They are most effective when the interfering signal is far from the operating frequency.
3. **Use a resonant antenna.** A resonant antenna favors signals in the band it was cut for.
4. **Re-position or use a smaller antenna.** Changing the direction the dipole faces may lower unwanted pickup of undesired SW signals. Lowering the antenna will change its angle of pickup; a low antenna may favor local stations over the low-angle of distant broadcast signals. A shorter antenna can also be tried, it will be less efficient and signals will be weaker.

## **IN CASE OF DIFFICULTY**

Only high-quality components and proven circuit designs are used in Vectronics kits. In very rare instances is a defective component the source of a problem. Ninety-five percent of the kits returned for factory repair are due to soldering problems or parts in the wrong locations. We advise repeating the assembly instructions step-by-step, looking for mistakes or soldering problems. Be especially wary of electrolytic capacitors and semiconductors. Kit builders often miss obvious mistakes. What is needed is a “fresh” set of eyes. Enlist a friend to go over your work.

*Always check the obvious!* Is the battery dead, or have the battery leads been accidentally reversed or broken? The speaker and antenna plug should be carefully checked for shorted or open connections. Check the solder connections for the antenna and speaker jacks—frequent removal and insertion may have caused a solder joint to fatigue and open.

Look for clues to help you determine what stages are working, and which ones may be in trouble. For example, if you can “peak” the RF input tuning for an increase of background noise, or hiss, in the headphones or speaker with an antenna connected, you know that the receiver is probably working. The problem is probably due to the set being aligned for a tuning range covering inactive frequencies.

You can “prove” the LO is working by listening for its signal on a monitor receiver. See if this general checklist helps isolate your problem:

- 1. Does not turn on:** Check battery condition, snap clip, and power leads. Also, make sure lead polarity is correct (red to +, black to GND). Make sure power switch is “on”. Check operating voltages.
- 2. Turns on, does not receive signals:** Check antenna, antenna lead, and plug for shorted or open condition. Also, radio may not pick up signals in metal building without an outdoor antenna.
- 3. Drifts off-frequency rapidly, “motorboats”, weak audio:** Symptoms of a weak battery or insufficient operating voltage. Be sure to check battery voltage “under load” (with the radio turned on).
- 4. Poor sensitivity:** Look for antenna problems.

**Quick voltage checks:**

Pin 8 of U1 (NE602)	5.0 volts
Pin 6 of U3 (LM386)	9.0 volts (battery voltage)
Pin 5 of U3 (LM386)	4.5 volts, no signal (about ½ battery voltage)
Pin 7 of U1 (NE602)	80-mV RMS RF oscillator voltage

If all else fails, and factory service is needed, consult the warranty information at the beginning of the manual.

## **THEORY OF OPERATION AND SPECIFICATIONS**

### **Technical Circuit Description:**

Potentiometer R1 serves as a continuously variable RF attenuator and is the receiver gain control. Using the RF gain control to set volume is advantageous as it also reduces strong in-band signals that could otherwise overload the receiver front end.

Series inductors L2 and L3, and trimmer capacitor C18, provide front-end band-pass filtering, and an impedance match to 50 to 75-ohm antenna systems. IC U1 is an NE602/612 mixer and Local Oscillator in an 8-pin dip package. The mixer section is an active Gilbert cell design for good conversion gain and low-noise figure. The LO section uses heavy capacitive loading to minimize frequency drift. Tuning is capacitive, using a modern Hi-Q miniature plastic variable.

Since this is a direct conversion receiver, the LO is tuned to the carrier frequency of Single Sideband Signals, or to an difference of 300 to 800 Hz on CW signals, to produce an aural output that is differentially coupled to a LM386 audio IC. LO stability is enhanced by a 78L05 voltage regulator.

### **Specifications:**

Sensitivity.....	3-uV or better
Modes.....	CW, RTTY (FSK), SSB, AM
Audio output.....	50 mW typical
Frequency coverage.....	Portions of the 80, 75, 40 and 30 meter bands
Power Source.....	9 Volt transistor battery, alkaline preferred.
PC Board.....	4.000" x 4.700"



**SCHEMATIC**

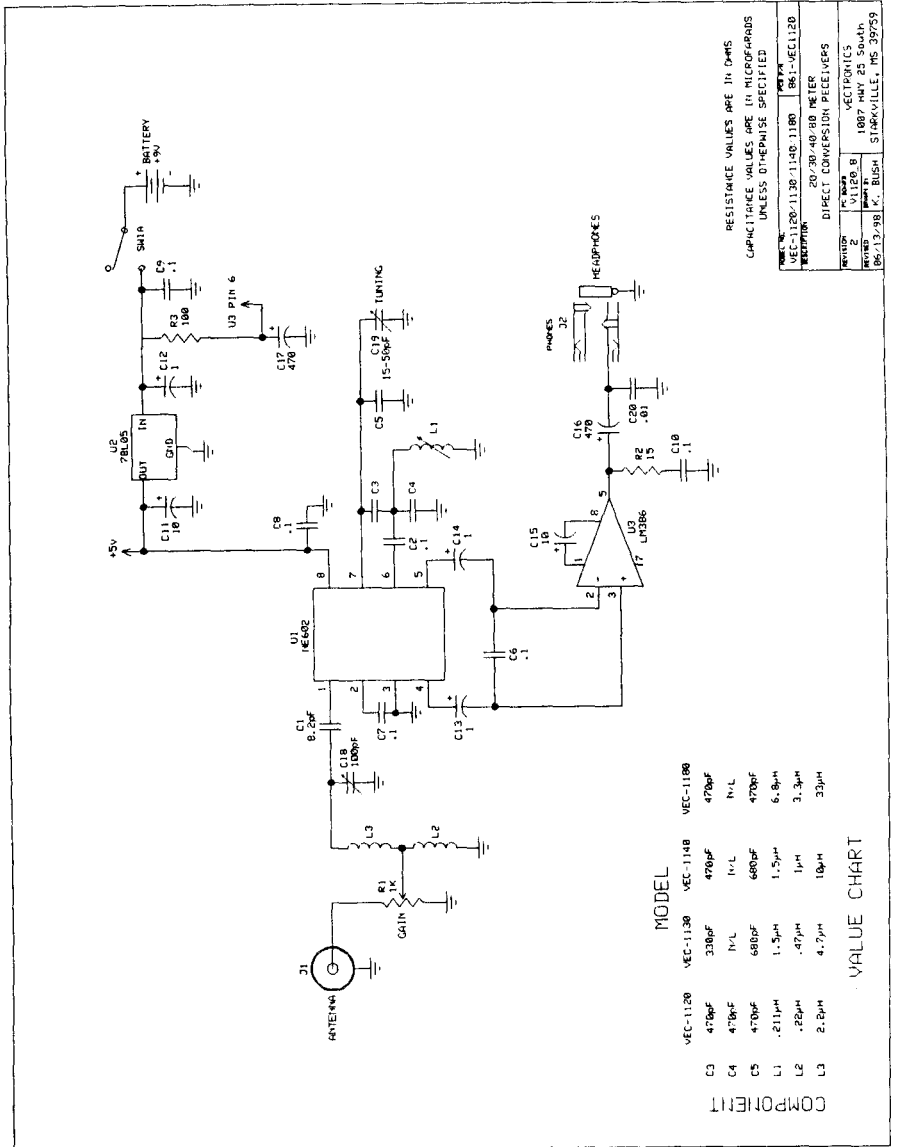

MODEL VALUE CHART

MODEL	VEC-1120	VEC-1130	VEC-1140	VEC-1180
C3	470pF	330pF	470pF	470pF
C4	470pF	10pF	10pF	10pF
C5	470pF	680pF	680pF	470pF
L1	211μH	1.5μH	1.5μH	6.8μH
L2	.22μH	.47μH	1μH	3.3μH
L3	2.2μH	4.7μH	18μH	33μH

RESISTANCE VALUES ARE IN OHMS  
 CAPACITANCE VALUES ARE IN MICROFARADS  
 UNLESS OTHERWISE SPECIFIED

VEC-1120/1130/1140/1180 881-VECL120  
 MICROWAVE 20/20/40/80 METER  
 DIRECT CONVERSION RECEIVERS

DESIGNED BY: J. BUSH  
 DRAWN BY: J. BUSH  
 DATE: 08/13/98  
 LOCATION: STARBUCKVILLE, MS 39759

## **ENCLOSURE**

Vectronics has designed a matching enclosure just for your Direct Conversion Receiver Kit. The matching enclosure is an all metal box which includes knobs, hardware, decals, and rubber feet. **Enclosure model: VEC-1100KC.**

To install your receiver in the VEC-1100KC matching enclosure follow these instructions (*read **all** instructions before beginning ... take your time*):

1. Find the front panel decal that corresponds with your receiver and the rear panel decal; separate using scissors. Put the rear panel decal on first. This is done by: **a.)** Remove all debris and oil from the chassis. **b.)** Remove the decal and peel to expose the adhesive. **c.)** Place the decal on the rear panel without securing it completely. **d.)** Gently rub the alignment circles with your finger--if the circles are centered in the enclosure holes (also check the corner alignment marks) secure the decal by rubbing and removing all air bubbles. **e.)** If the alignment circles are not centered, adjust the decal accordingly then secure. **f.)** Use a penknife, or small Exacto™ knife, to cut away the unused edges and cut out the component holes. **g.)** Repeat procedure for the front panel.
2. Next, install the two L-brackets on the chassis using two of the 3/16" screws. The longer side of the L-bracket must be connected to the chassis using the two holes centered on each edge of the enclosure. Refer to the diagram on the next page for location and orientation.
3. Install the four 1/2" mounting screws next. Insert the screws, from the bottom, through the four holes relatively close to each corner of the chassis.
4. Place the four 3/16" round spacers on the mounting screws.
5. Now insert the PC board. This must be done by: **a.)** Remove the nut and washer from R1. **b.)** Insert the front of the PC board at an angle, **c.)** then push down on the rear of the board. Make sure the mounting screws align with the mounting holes in the PC board before pushing.
6. Use the four hex nuts to secure the PC board. Be certain all appropriate components are centered with the enclosure holes before tightening. Put the washer and nut (removed from R1) back on R1 and tighten.
7. Find the knobs and switch cap. Align the switch cap with SW1 and push it on. If it is difficult to push on, then rotate it 90° and try again. Now put the knobs on R1 and C19. You may need to loosen the set screw. Align appropriately then tighten the set screw.
8. The top should now be installed. Use the two remaining 3/16" screws for securing the top to the L-brackets.
9. Place the four rubber feet on the bottom of the enclosure at the corners.

