

IMPORTANT WARRANTY INFORMATION! PLEASE READ

Return Policy on Kits When *Not* Purchased Directly From Vectronics: Before continuing any further with your VEC kit check with your Dealer about their return policy. If your Dealer allows returns, your kit must be returned *before* you begin construction.

Return Policy on Kits When Purchased Directly From Vectronics: Your VEC kit may be returned to the factory *in its pre-assembled condition only*. The reason for this stipulation is, once you begin installing and soldering parts, you essentially take over the role of the device's manufacturer. From this point on, neither Vectronics nor its dealers can reasonably be held accountable for the quality or the outcome of your work. Because of this, Vectronics cannot accept return of any kit-in-progress or completed work as a warranty item for any reason whatsoever. If you are a new or inexperienced kit builder, we urge you to read the manual carefully and determine whether or not you're ready to take on the job. If you wish to change your mind and return your kit, you may--but you must do it *before* you begin construction, and within ten (10) working days of the time it arrives.

Vectronics Warrants: Your kit contains each item specified in the parts list.

Missing Parts: If you determine, during your pre-construction inventory, that any part is missing, please contact Vectronics and we'll send the missing item to you free of charge. However, *before* you contact Vectronics, *please look carefully* to confirm you haven't misread the marking on one of the other items provided with the kit. Also, make certain an alternative part hasn't been substituted for the item you're missing. If a specific part is no longer available, or if Engineering has determined that an alternative component is more suitable, Vectronics reserves the right to make substitutions at any time. In most cases, these changes will be clearly noted in an addendum to the manual.

Defective Parts: Today's electronic parts are physically and electrically resilient, and defective components are rare. However, if you discover an item during your pre-construction inventory that's obviously broken or unserviceable, we'll replace it. Just return the part to Vectronics at the address below accompanied with an explanation. Upon receipt, we'll test it. If it's defective and appears unused, we'll ship you a new one right away at no charge.

Missing or Defective Parts After You Begin Assembly: Parts and materials lost or damaged *after construction begins* are not covered under the terms of this warranty. However, most parts supplied with VEC kits are relatively inexpensive and Vectronics can replace them for a reasonable charge. Simply contact the factory with a complete description. We'll process your order quickly and get you back on track.

Factory Repair After You Begin Assembly: *Kits-in progress and completed kits are specifically excluded from coverage by the Vectronics warranty.* However, as a service to customers, technicians are available to evaluate and repair malfunctioning kits for a minimum service fee of \$18.00 (½ hour rate) plus \$7.00 shipping and handling (prices subject to change). To qualify for repair service, your kit must be fully completed, unmodified, and the printed circuit board assembled using rosin-core solder. In the event your repair will require more than an hour to fix (or \$36.00, subject to change), our technicians will contact you in advance by telephone before performing the work. Defective units should be shipped prepaid to:

Vectronics
1007 HWY 25 South
Starkville, MS 39759

When shipping, pack your kit well and include the minimum payment plus shipping and handling charges (\$25.00 total). No work can be performed without pre-payment. Also, provide a valid UPS return address and a day time phone number where you may be reached.

INTRODUCTION

This kit provides a great introduction to QRP operation, one of the hottest and fastest growing activities in amateur radio. With these little rigs, you'll discover what thousands of QRP enthusiasts already know--the magic of communicating world-wide using less energy than it takes to illuminate a pen-light bulb!

Your VEC QRP-CW Transmitter Kit is simple to build, yet it gives you many sophisticated features to make QRP operating both easy and fun. For example, a built-in diode antenna switch handles T/R transfer in milliseconds for full QSK operation in between CW characters. In fact, if your receiver has a good AGC, you can simply plug into the T/R jack and copy both sides of the conversation simultaneously, without receiver muting. In addition to full QSK, you get shaped keying--just like on the most expensive commercial transceivers.

For drift-free frequency stability, the transmitter is crystal-controlled. However, that doesn't mean you're "stuck" in one spot. The wide-range VXO circuit uses a high-Q variable-capacitor for maximum frequency shift. Also, a second optional crystal frequency may be added and selected with the push of a switch. Best of all, there's no need to order crystals to get started--each kit already includes one cut for the internationally recognized QRP calling-frequency on that band.

Finally, when your kit is assembled and it's time to fire up, you won't need to fiddle with tricky tuning--or to substitute output transistors for best results. You'll get a solid 1-watt *plus* signal that's filtered through a high-Q toroid low-pass filter to ensure compliance with FCC rules. In short, your kit provides everything you need to get on the air fast!

TOOLS AND SUPPLIES

Construction Area: Kit construction requires a clean, smooth, and well-lighted area where you can easily organize and handle small parts without losing them. An inexpensive sheet of white poster board makes an excellent construction surface, while providing protection for the underlying table or desk. Well-diffused overhead lighting is a plus, and a supplemental high-intensity desk lamp will prove especially helpful for close-up work. Safety is an important consideration. Be sure to use a suitable high-temperature stand for your soldering iron, and keep the work area free of combustible clutter.

Universal Kit-building Tools: Although your particular kit may require additional items to complete, virtually all construction projects require a work area outfitted with the following tools and supplies:

- Soldering Iron

- High-temperature Iron Holder with Cleaning Sponge
- Rosin-core Solder (thin wire-size preferred)
- Needle Nose Pliers or Surgical Hemostats
- Diagonal Cutters or "Nippy Cutters"
- Solder Sucker, Vacuum Pump, or Desoldering Braid
- Bright Desk Lamp
- Magnifying Glass

Special Tools for This Kit:

- RF power meter or VSWR bridge
- 50-ohm dummy load or 1-watt 47 ohm carbon-film resistor
- Telegraph key with a 3.5 mm "mini" phone plug.
- LED (any color)

BEFORE YOU START BUILDING

Experience shows there are *four common mistakes* builders make. Avoid these, and your kit will probably work on the first try! Here's what they are:

- 1. Installing the Wrong Part:** It always pays to double-check each step. A 1K and a 10K resistor may look *almost* the same, but they may act very differently in an electronic circuit! Same for capacitors--a device marked 102 (or .001 uF) may have very different operating characteristics from one marked 103 (or .01uF).
- 2. Installing Parts Backwards:** Always check the polarity of electrolytic capacitors to make sure the positive (+) lead goes in the (+) hole on the circuit board. Transistors have a flat side or emitter tab to help you identify the correct mounting position. ICs have a notch or dot at one end indicating the correct direction of insertion. Diodes have a banded end indicating correct polarity. Always double-check--especially before applying power to the circuit!
- 3. Faulty Solder Connections:** Inspect for cold-solder joints and solder bridges. Cold solder joints happen when you don't fully heat the connection--or when metallic corrosion and oxide contaminate a component lead or pad. Solder bridges form when a trail of excess solder shorts pads or tracks together (see Soldering Tips below).

- 4. Omitting or Misreading a Part:** This is easier to do than you might think! Always double-check to make sure you completed each step in an assembly sequence.

Soldering Tips:

Cleanliness and good *heat distribution* are the two secrets of professional soldering. Before you install and solder each part, inspect leads or pins for oxidation. If the metal surface is dull, sand with fine emery paper until shiny. Also, clean the oxidation and excess solder from the soldering iron tip to ensure maximum heat transfer. Allow the tip of your iron to contact both the lead and pad for about one second (count "one-thousand-one") before feeding solder to the connection. Surfaces must become hot enough for solder to *flow smoothly*. Feed solder to the opposite side of the lead from your iron tip--solder will wick around the lead toward the tip, wetting all exposed surfaces. Apply solder sparingly, and do not touch solder directly to the hot iron tip to promote rapid melting.

Desoldering Tips:

If you make a mistake and need to remove a part, follow these instructions carefully! First, grasp the component with a pair of hemostats or needle-nose pliers. Heat the pad beneath the lead you intend to extract, and pull gently. The lead should come out. Repeat for the other lead. Solder may fill in behind the lead as you extract it--especially if you are working on a double-sided board with plate-through holes. Should this happen, try heating the pad again and inserting a common pin into the hole. Solder won't stick to the pin's chromium plating. When the pad cools, remove the pin and insert the correct component. For ICs or multi-pin parts, use desoldering braid to remove excess solder before attempting to extract the part. Alternatively, a low-cost vacuum-bulb or spring-loaded solder sucker may be used. Parts damaged or severely overheated during extraction should be replaced rather than reinstalled.

Work Habits:

Kit construction requires the ability to follow detailed instructions and, in many cases, to perform new and unfamiliar tasks. To avoid making needless mistakes, work for short periods when you're fresh and alert. Recreational construction projects are more informative and more fun when you take your time. Enjoy!

Sorting and Reading Resistors:

The electrical value of resistors is indicated by a color code (shown below). You don't have to memorize this code to work with resistors, but you do need to understand how it works:

Resistor Color Code

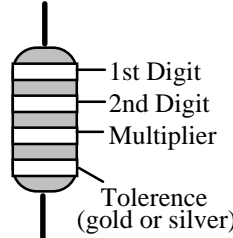





Black	= 0 (tens)	Blue	= 6
Brown	= 1 (hundreds)	Violet	= 7
Red	= 2 (K)	Gray	= 8
Orange	= 3 (10K)	White	= 9
Yellow	= 4 (100K)	Silver	= 10%
Green	= 5 (1Meg)	Gold	= 5%

When you look at a resistor, check its multiplier code first. Any resistor with a black multiplier band falls between 10 and 99 ohms in value. Brown designates a value between 100 and 999 ohms. Red indicates a value from 1000 to 9999 ohms, which is also expressed as 1.0K to 9.9K. An orange multiplier band designates 10K to 99K, etc. To sort and inventory resistors, first separate them into groups by multiplier band (make a pile of 10s, 100s, Ks, 10Ks, etc.). Next, sort each group by specific value (1K, 2.2K, 4.7K, etc.). This procedure makes the inventory easier, and also makes locating specific parts more convenient later on during construction. Some builders find it especially helpful to arrange resistors in ascending order along a strip of double-sided tape.

Some VEC kits may contain molded chokes which appear, at first glance, similar to resistors in both shape and band marking. However, a closer look will enable you to differentiate between the two--chokes are generally larger in diameter and fatter at the ends than resistors. When doing your inventory, separate out any chokes and consult the parts list for specific color-code information.

Reading Capacitors:

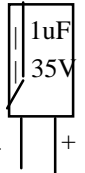
Unlike resistors, capacitors no longer use a color code for value identification. Instead, the value, or a 3-number code, is printed on the body.

Value	Code		Ceramic Discs	Electrolytic
10 pF	= 100			1 uF
100 pF	= 101	Multilayer	(.001 uF)	1uF
1000 pF	= 102	(270 pF)	(.1 uF)	35V
.001 uF	= 102*			
.01 uF	= 103			-
.1 uF	= 104			+

As with resistors, it's helpful to sort capacitors by type, and then to arrange them in ascending order of value. Small-value capacitors are characterized in pF (or pico-Farads), while larger values are labeled in uF (or micro-Farads). The transition from pF to uF occurs at 1000 pF (or .001 uF)*. Today, most

monolithic and disc-ceramic capacitors are marked with a three-number code. The first two digits indicate a numerical value, while the last digit indicates a multiplier (same as resistors).

Electrolytic capacitors are always marked in μF . Electrolytics are polarized devices and must be oriented correctly during installation. If you become confused by markings on the case, remember the uncut negative lead is slightly shorter than the positive lead.

Diodes:

Diodes are also polarized devices that must be installed correctly. Always look for the banded or cathode end when installing, and follow instructions carefully.

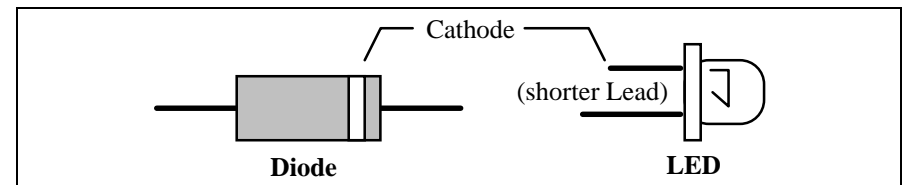

Transistors:

If transistors are installed incorrectly, damage may result when power is applied. Transistors in metal cases have a small tab near the emitter lead to identify correct positioning. Semiconductors housed in small plastic cases (TO-92) have an easily-identified flat side to identify mounting orientation. Many specialized diodes and low-current voltage regulators also use this type packaging. Larger plastic transistors and voltage regulators use a case backed with a prominent metal tab to dissipate heat (T-220). Here orientation is indicated by the positioning of the cooling tab.

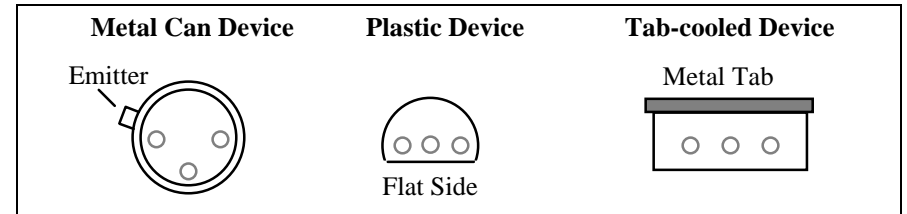

Integrated Circuits:

Proper IC positioning is indicated by a dot or square marking located on one end of the device. A corresponding mark will be silk-screened on the PC board and printed on the kit's parts-placement diagram. To identify specific IC pin numbers for testing purposes, see the diagram below. Pin numbers always start at the keyed end of the case and progress counter-clockwise around the device, as shown:

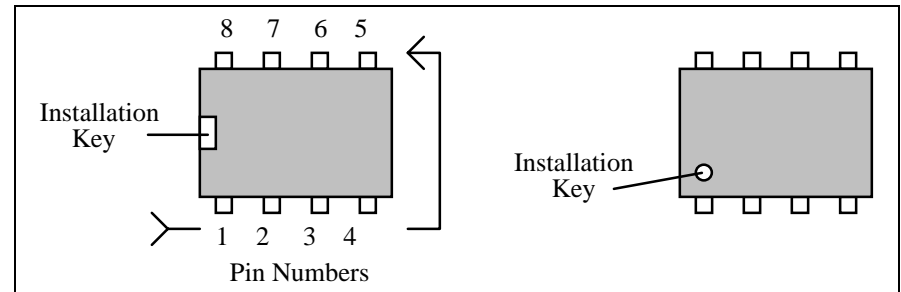

PARTS LIST

The parts list for your kit is presented in two parts. First, you'll identify and inventory the *generic* parts--those items common to all VEC QPR transmitter kits regardless of band. Then, you'll inventory the parts specifically for your particular VEC QPR transmitter, which contains *frequency-critical* parts that determine the specific band of operation.

If any parts are missing or damaged, refer to the manual's warranty section for replacement instructions. If you can't positively identify an unfamiliar item on the basis of the information given, set it aside until all other items are checked off. You may then be able to identify it by process of elimination. Finally, your kit will go together more smoothly if parts are organized by type and arranged by value ahead of time. Use this inventory as an opportunity to sort and arrange parts so you can identify and find them quickly.

First, locate and identify the *generic* parts bags. These items are common to all four models of the VEC QRP-CW Transmitter Kit:

Generic Parts

Resistors: (fourth gold color band indicates 5% tolerance)

<input checked="" type="checkbox"/>	Qty	Part Description	Designation
<input type="checkbox"/>	2	100 ohm (brown-black-brown)	R4,R7
<input type="checkbox"/>	1	270 ohm (red-violet-brown)	R8
<input type="checkbox"/>	3	470 ohm (yellow-violet-brown)	R5,R9,R11
<input type="checkbox"/>	1	1K (brown-black-red)	R10
<input type="checkbox"/>	3	10K (brown-black-orange)	R1,R2,R3
<input type="checkbox"/>	1	47K (yellow-violet-orange)	R6

Capacitors:

<input checked="" type="checkbox"/>	Qty	Part Description	Designation
-------------------------------------	-----	------------------	-------------

<input type="checkbox"/>	10	.1 uF disc ceramic (103 or 103Z)	C1,C3,C9,C10,C11 C12,C15,C17,C18,C21
<input type="checkbox"/>	1	470 uF electrolytic	C4
<input type="checkbox"/>	1	.1 uF disc ceramic (104 or 104Z)	C2
<input type="checkbox"/>	1	multi-section variable capacitor	C5

Chokes, Coils: (molded chokes are larger than resistors)

<input checked="" type="checkbox"/>	Qty	Part Description	Designation
<input type="checkbox"/>	2	100 uH (brown, black, brown, silver)	RFC4, RFC5
<input type="checkbox"/>	1	T37-2 toroid form (round, red)	L1

Semiconductors:

<input checked="" type="checkbox"/>	Qty	Part Description	Designation
<input type="checkbox"/>	1	2N3906 transistor	Q1
<input type="checkbox"/>	1	2N3904 transistor	Q2
<input type="checkbox"/>	1	PN2222 transistor	Q3
<input type="checkbox"/>	1	2N3053 transistor	Q4
<input type="checkbox"/>	2	1N4007 diode	D1,D2
<input type="checkbox"/>	1	1N4148 diode	D3

Jacks, Switches:

<input checked="" type="checkbox"/>	Qty	Part Description	Designation
<input type="checkbox"/>	1	3.5mm key jack	J1
<input type="checkbox"/>	1	2.1mm coaxial power jack	J2
<input type="checkbox"/>	2	RCA type phone jack	J3,J4
<input type="checkbox"/>	2	DPDT push-button switch	SW1,SW2

Miscellaneous Items:

<input checked="" type="checkbox"/>	Qty	Part Description
<input type="checkbox"/>	1	clip-on transistor heat sink
<input type="checkbox"/>	1	printed circuit board
<input type="checkbox"/>	1	instruction manual
<input type="checkbox"/>	1	length, double-sided tape
<input type="checkbox"/>	1	1/2" tuning shaft extension

Now, to complete the inventory, select the correct list below for the *specific model of your kit*--and check off those items:

VEC-1220K (20-Meter QRP-CW Transmitter Kit)
--

Capacitors:

<input checked="" type="checkbox"/>	Qty	Part Description	Designation
-------------------------------------	-----	------------------	-------------

<input type="checkbox"/>	1	22 pF multilayer (22 or 220)	C6
<input type="checkbox"/>	1	47 pF multilayer (47 or 470)	C8
<input type="checkbox"/>	1	68 pF multilayer (68 or 680)	C16
<input type="checkbox"/>	3	220 pF multilayer (221)	C7,C19,C20
<input type="checkbox"/>	1	330 pF multilayer (331)	C14
<input type="checkbox"/>	1	470 pF multilayer (471)	C13

Inductors/Chokes:

<input checked="" type="checkbox"/>	Qty	Part Description	Designation
<input type="checkbox"/>	3	1.8 uH (brown, gray, gold, silver)	RFC1,RFC2,RFC3
<input type="checkbox"/>	1	12" length of #22 enameled wire	for L1

Crystal:

<input checked="" type="checkbox"/>	Qty	Part Description	Designation
<input type="checkbox"/>	1	14.060 MHz crystal	Y1

VEC-1230K (30-Meter QRP-CW Transmitter Kit)**Capacitors:**

<input checked="" type="checkbox"/>	Qty	Part Description	Designation
<input type="checkbox"/>	1	33 pF multilayer	C6
<input type="checkbox"/>	1	47 pF multilayer	C8
<input type="checkbox"/>	1	100 pF multilayer	C16
<input type="checkbox"/>	1	220 pF multilayer	C7
<input type="checkbox"/>	2	330 pF multilayer	C19,C20
<input type="checkbox"/>	1	470 pF multilayer	C13
<input type="checkbox"/>	1	680 pF multilayer	C14

Inductors/Chokes:

<input checked="" type="checkbox"/>	Qty	Part Description	Designation
<input type="checkbox"/>	3	2.2 uH (red, red, gold, silver)	RFC1,RFC2,RFC3
<input type="checkbox"/>	1	12" length of #22 enameled wire	L1

Crystal:

<input checked="" type="checkbox"/>	Qty	Part Description	Designation
<input type="checkbox"/>	1	10.108 MHz crystal	Y1

VEC-1240K (40-Meter QRP-CW Transmitter Kit)**Capacitors:**

<input checked="" type="checkbox"/>	Qty	Part Description	Designation
<input type="checkbox"/>	1	47 pF multilayer	C6
<input type="checkbox"/>	2	100 pF multilayer	C8,C16

<input type="checkbox"/>	1	220 pF multilayer	C7
<input type="checkbox"/>	3	470 pF multilayer	C13,C19,C20
<input type="checkbox"/>	1	1000 pF multilayer	C14

Inductors/Chokes:

<input checked="" type="checkbox"/>	Qty	Part Description	Designation
<input type="checkbox"/>	3	4.7 uH (yellow, violet, gold, silver)	RFC1,RFC2,RFC3
<input type="checkbox"/>	1	12" length of #24 enameled wire	L1

Crystal:

<input checked="" type="checkbox"/>	Qty	Part Description	Designation
<input type="checkbox"/>	1	7.040 MHz crystal	Y1

VEC-1280 (80-Meter QRP-CW Transmitter Kit)**Capacitors:**

<input checked="" type="checkbox"/>	Qty	Part Description	Designation
<input type="checkbox"/>	1	68 pF multilayer	C6
<input type="checkbox"/>	1	100 pF multilayer	C8,C16
<input type="checkbox"/>	2	470 pF multilayer	C13,C16
<input type="checkbox"/>	2	820 pF multilayer	C19,C20
<input type="checkbox"/>	2	1000 pF multilayer	C7,C14

Inductors/Chokes:

<input checked="" type="checkbox"/>	Qty	Part Description	Designation
<input type="checkbox"/>	3	10 uH (brown, black, black, silver)	RFC1,RFC2,RFC3
<input type="checkbox"/>	1	12" length of #24 enameled wire	for L1

Crystal:

<input checked="" type="checkbox"/>	Qty	Part Description	Designation
<input type="checkbox"/>	1	3.579 MHz crystal	Y1

Once again, if any parts are missing, consult the warranty page on the inside cover for specific replacement instructions. If your parts inventory is complete, you're ready to start building. Remember, once construction begins, you may no longer return your kit.

Many builders find it helpful to make a Xerox copy of the parts placement diagram and the schematic diagram. These may then be posted in your work

Inductors/Chokes:

<input checked="" type="checkbox"/>	Qty	Part Description	Designation
<input type="checkbox"/>	3	10 uH (brown, black, black, silver)	RFC1,RFC2,RFC3
<input type="checkbox"/>	1	12" length of #24 enameled wire	for L1

Crystal:

<input checked="" type="checkbox"/>	Qty	Part Description	Designation
<input type="checkbox"/>	1	3.579 MHz crystal	Y1

Once again, if any parts are missing, consult the warranty page on the inside cover for specific replacement instructions. If your parts inventory is complete, you're ready to start building. Remember, once construction begins, you may no longer return your kit.

Many builders find it helpful to make a Xerox copy of the parts placement diagram and the schematic diagram. These may then be posted in your work area for reference. A parts placement layout is also printed on the circuit board to help you locate where to install each part.

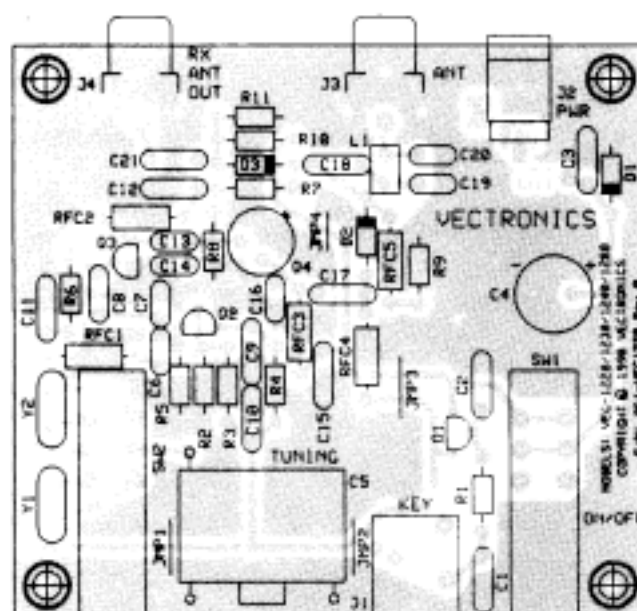
PARTS PLACEMENT

STEP-BY-STEP ASSEMBLY

Your VEC QRP-CW Transmitter Kit will be constructed in three stages. First, you'll install the smaller *generic* parts (resistors, capacitors, etc.) that are common to all four models. Next, you'll mount *frequency-determining* components--those parts that determine the specific band of operation for your particular kit. Finally, you'll complete the project by installing larger *generic* parts such as jacks and switches--things that might get in the way if installed first.

In these instructions, when you see the term *install*, this means to locate, identify, and insert the part into its mounting holes on the PC board. This includes pre-bending or straightening leads as needed so force is not required to seat the part. Once a component is mounted, bend each lead over to hold it in place. Use sharp side-cutters to clip off excess lead length before soldering. Make sure trimmed leads don't touch other pads and tracks, or a short circuit may result:

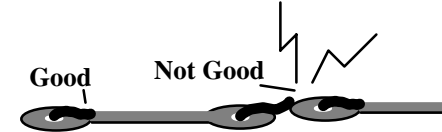

The term *solder* means to solder the part's leads in place, and to inspect both (or all) solder connections for flaws or solder bridges. Nip off excess protruding leads with a sharp pair of side cutters.

This kit contains 11 fixed-value 1/4-watt resistors. Begin construction by mounting these first, starting with the smallest value and moving to the largest. Before installing each one, carefully bend both leads to form right-angles, as shown below:

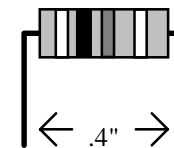

When installing resistors, save some of the clipped-off resistor lead ends--you'll need these for pc-board jumpers later on.

Phase 1: Resistors

Find two (2) 100 ohm resistors (brown-black-brown).

- 1. Install a 100 ohm resistor at R4 and solder.
- 2. Install a 100 ohm resistor at R7 and solder.
- 3. Find a 270 ohm resistor (red-violet-brown). Install this at R8 and solder.

Find three (3) 470 ohm resistors (yellow-violet-brown).

- 4. Install a 470 ohm resistor at R5 and solder.
- 5. Install a 470 ohm resistor at R9 and solder.
- 6. Install a 470 ohm resistor at R11 and solder.
- 7. Locate a 1K resistor (brown-black-red). Install at R10 and solder.

Find three (3) 10K resistors (brown-black-orange).

- 8. Install a 10K resistor at R1 and solder.
- 9. Install a 10K at R2 and solder.
- 10. Install a 10K at R3 and solder.
- 11. Find a 47K resistor (yellow-violet-orange). Install at R6 and solder.

This completes installation of the 11 fixed-value resistors supplied with the kit. Take a moment to inspect your solder connections and to confirm each resistor has been installed in the right PC board location. Next, you'll install the kit's 11 disc ceramic capacitors. Note that *all but one* has a value of .01 uF.

Phase 2: Ceramic and Electrolytic Capacitors

Locate ten (10) .01 uF disc ceramic capacitors (marked 103).

- 1. Install a .01 uF disc ceramic at C1 and solder.
- 2. Install a .01 uF disc ceramic at C3 and solder.
- 3. Install a .01 uF disc ceramic at C9 and solder.
- 4. Install a .01 uF disc ceramic at C10 and solder.
- 5. Install a .01 uF disc ceramic at C11 and solder.
- 6. Install a .01 uF disc ceramic at C12 and solder.
- 7. Install a .01 uF disc ceramic at C15 and solder.
- 8. Install a .01 uF disc ceramic at C17 and solder.
- 9. Install a .01 uF disc ceramic at C18 and solder.
- 10. Install a .01 uF disc ceramic at C21 and solder.
- 11. Find the single .1 uF disc ceramic (104). Install this at C2 and solder.

Your kit also contains one electrolytic capacitor. ***Electrolytic caps are polarized and must be installed the correct way in order to work.*** The capacitor's plus (+) mounting hole is noted on both the circuit board and parts placement diagram. If

the markings on the capacitor body are unclear, the plus (+) lead is always the longer of the two.

- 12. Locate the 470 uF capacitor. Observing polarity, install this at C4 and solder.

This completes capacitor installation for now. There are several multilayer capacitors remaining, but these will be installed later as *frequency-determining* components. Also, the VXO variable capacitor will be installed near the end of construction because of its larger size. Before moving on, make a quick inspection of your work to make sure each part is installed at the correct location. Also, double-check the polarity of C4.

Now that you've accumulated good collection of nipped-off lead-ends, this is a good time to install the board's four (4) jumper leads. These jumpers tie together the ground areas surrounding the transmitter circuitry. Each should be pre-formed prior to installation, as shown below. An approximate distance between mounting holes is given to help you pre-form each one. When installed, each jumper should lay flat against the PC board.

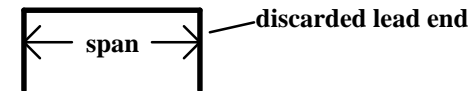

Phase 3: Jumpers

- 1. Form a 11/32" jumper and install at JMP1.
- 2. Form a 11/32" jumper and install at JMP2.
- 3. Form a 3/8" jumper and install at JMP3.
- 4. Form a 1/4" jumper and install at JMP4.

Save one additional resistor lead for connecting variable capacitor C5 later on.

There are five (5) molded-epoxy radio-frequency chokes in your kit. The two 100-uH chokes are *generic*, and should be installed now. Note that the fourth color-code band on a molded choke indicates tolerance. This may be either gold (5%) or silver (10%).

Phase 4: Chokes

Find the two 100 uH molded chokes (brown-black-brown-silver or gold).

- 1. Install 100 uH at RFC4
- 2. Install 100 uH at RFC5

Next, you'll install the kit's transistors and diodes. ***Positioning of these parts is critical--they must be oriented correctly.***

Phase 5: Transistors and Diodes

- 1. Locate the 2N3906 transistor (black plastic case), checking its identification markings closely. Find its flat side, and make sure this is aligned with the printed outline on the PC board before inserting the leads. Install the 2N3906 at Q1 and solder.

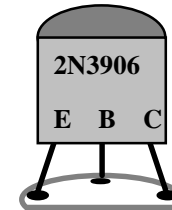

- 2. Locate a 2N3904 transistor (black plastic case). Install at Q2 and solder.
- 3. Locate a PN2222 transistor (black plastic case). Install at Q3 and solder.
- 4. Find the 2N3053 transistor (metal case). Install at Q4, inserting leads all the way so the metal case rests on the surface of the PC board. The metal "emitter" tab should point toward R7. Solder.

Locate two (2) 1N4007 diodes. Note the white band at one end of the diode case. When installing, position this band to correspond with the marking on the PC board.

- 5. Install a 1N4007 at D1, observing the position of the band. Solder.
- 6. Install a 1N4007 at D2, observing the position of the band. Solder.

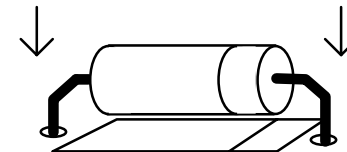

Save the clipped-off lead ends from the 1N4007s to use during installation of the VXO tuning capacitor later on. This stiff "bus wire" will be used to support the capacitor.

- 7. Locate a 1N4148 diode (small glass case). Identify the banded end and install at D3, matching the band to the PC board marking. Solder.

This concludes the first phase of construction (small generic parts). Next, you'll install frequency-determining components. However, before you start, this might be a good time to take a well-deserved break! Be sure to check transistor and diode positioning and polarity before moving on.

Phase 7: Frequency-Determining Parts

In this section, you'll select a *specific set of instructions for your particular kit* (VEC-1220K, VEC-1230K, etc). However, before you do this, please review these two important general construction tips that apply to all four models of the kit.

Installing Multilayer Capacitors: There are 8 multilayer capacitors in your kit. A multilayer cap is similar to a surface-mount "chip" capacitor, except that it has a lead spot-welded onto each end of the capacitor body. Each cap is then coated with an epoxy coating. Multilayers have superior radio-frequency operating characteristics, but the lead welds may fail if the leads are placed under stress while being heated during installation or removal. For this reason, *never use force to seat a multilayer cap* into the PC board. If the spacing isn't right, pre-form the leads to the correct spacing before installation!

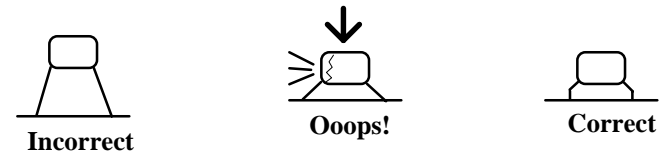

Winding and Installing Toroid Coil L1: The transmitter's low-pass filter uses a high-Q toroid inductor wound on a T37-2 form (T37 means the powdered-iron form is .37-inches in diameter). When winding L1, the number of turns are counted *inside the form* (not on the outside). This means, if the instructions call for a 12-turn coil, you must *pass the wire through the center of the core* 12 times.

When winding this coil, be sure to pull each turn up tight before starting the next. If the coil is wound loosely, its inductance increases--a condition that may reduce transmitter output power.

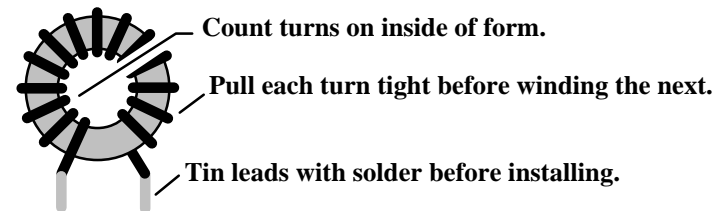

Finally, before installing L1 on the PC board, be sure to tin both leads with solder. The coil wire provided with your kit is coated with heat-stripable enamel insulation that breaks down at soldering-iron temperatures. If you touch the tip of an iron to the end of the wire for several seconds, the insulation should start to melt, allowing solder to adhere to the copper underneath. If your iron isn't hot enough to start this process, carefully scrape the insulation off with a small hobby knife and tin.

If necessary, refer back to these instructions at any time during assembly. You may now move ahead to the section of the manual that corresponds with your particular kit.

VEC-1220K 20-Meter ORP-CW Transmitter Kit

- 1. Find a 22 pF multilayer cap (marked 22 or 220). Install at C6 and solder.
- 2. Find a 47 pF multilayer cap (47 or 470). Install at C8 and solder.
- 3. Find a 68 pF multilayer cap (68 or 680). Install at C16 and solder.
Find three (3) 220 pF multilayer caps (marked 221).
- 4. Install a 220 pF multilayer at C7 and solder.
- 5. Install a 220 pF multilayer at C19 and solder.
- 6. Install a 220 pF multilayer at C20 and solder.
- 7. Find a 330 pF multilayer cap (marked 331). Install at C14 and solder.
- 8. Find the remaining 470 pF multilayer cap (471). Install at C13 and solder.

Locate three (3) 1.8 uH chokes (brown-gray-gold-silver or gold).

- 9. Install 1.8 uH at RFC1 and solder.
- 10. Install 1.8 uH at RFC2 and solder.
- 11. Install 1.8 uH at RFC3 and solder.

Locate the T37-2 toroid coil form (a donut-shaped part about 3/8" in diameter and color-coded red). Also, find the #22 enameled coil wire provided with your kit.

- 12. Wind twelve (12) turns of #22 wire onto the T37-2 form. Note that turns are counted *inside* the form, and each turn is pulled tight before winding the next. When done, spread the windings out, distributing them over 80% of the form's circumference.
- 13. Trim each coil lead to 1/2" in length and tin with solder.

- 14. Install the coil at L1 and solder.
- 15. Locate the 14.060 MHz crystal (metal can, two wire leads). Install at Y1 and solder.

This completes stage 2 construction of the **VEC-1220K 20-meter kit**. After checking for errors, you may now move on to the final stage of construction.

VEC-1230K 30-Meter QRP-CW Transmitter Kit

- 1. Find a 33 pF multilayer capacitor (marked 33 or 330). Install at C6 and solder.
 - 2. Find a 47 pF multilayer cap (47 or 470). Install at C8 and solder.
 - 3. Find a 100 pF multilayer cap (101). Install at C16 and solder.
 - 4. Find a 220 pF multilayer cap (221). Install at C7 and solder.
- Find two (2) 330 pF multilayer caps (331).
- 5. Install 330 pF at C19 and solder.
 - 6. Install 330 pF at C20 and solder.
 - 7. Find a 470 pF multilayer cap (471). Install at C13 and solder.
 - 8. Find the remaining 680 pF multilayer cap (681). Install at C14 and solder.

Locate three (3) 2.2 uH molded chokes (red-red-gold-silver or gold)

- 9. Install a 2.2 uH choke at RFC1 and solder.
- 10. Install a 2.2 uH choke at RFC2 and solder.
- 11. Install a 2.2 uH choke at RFC3 and solder.

Locate the T37-2 toroid form, a donut-shaped part about 3/8" in diameter and color-coded red. Also, find the #22 enameled coil wire provided with your kit.

- 12. Wind fifteen (15) turns of #22 wire onto the T37-2 form. Turns are counted *inside the form*, and each one is pulled tight before winding the next. When done, spread windings to distribute them over 80% of the form's circumference.
- 13. Trim coil leads to 1/2" and tin with solder.
- 14. Install the coil at L1 and solder.
- 15. Locate the 10.108 MHz crystal (metal can, two wire leads). Install at Y1 and solder.

This completes stage 2 construction of the **VEC-1230K 30-meter kit**. After checking for errors, you may now move on to the final stage of construction.

VEC-1240K 40-Meter CW Transmitter Kit

1. Find a 47 pF multilayer capacitor (47 or 470). Install at C6 and solder.

Find two (2) 100 pF multilayer caps (101).

2. Install 100 pF at C8 and solder.
 3. Install 100 pF at C16 and solder.
 4. Find a 220 pF multilayer cap (221). Install at C7 and solder.

Find three (3) 470 pF multilayer caps (471).

5. Install 470 pF at C13 and solder.
 6. Install 470 pF at C19 and solder.
 7. Install 470 pF at C20 and solder.
 8. Find a 1000 pF multilayer cap (102). Install at C14 and solder.

Find three (3) 4.7 uH molded chokes (yellow-violet-gold-gold or silver).

9. Install a 4.7 uH choke at RFC1.
 10. Install a 4.7 uH choke at RFC2.
 11. Install a 4.7 uH choke at RFC3.

Locate the T37-2 toroid form, a donut-shaped part about 3/8" in diameter and color-coded red. Also, find the #24 enameled coil wire provided with your kit.

12. Wind eighteen (18) turns of #24 wire onto the T37-2 form. Turns are counted *inside* the form, and each one is pulled tight before winding the next. When done, spread windings to distribute them over 80% of the form's circumference.
13. Trim each lead to 1/2" tin with solder.
14. Install the coil at L1 and solder.
15. Locate the 7.040 MHz crystal (metal can, two wire leads). Install at Y1 and solder.

This completes stage 2 construction of the **VEC-1240K 40-meter kit**. After checking for errors, you may now move on to the final stage of construction.

VEC-1280K 80-Meter CW Transmitter Kit

1. Find a 68 pF multilayer capacitor (marked 68 or 680). Install at C6 and solder.

2. Find a 100 pF multilayer cap (101). Install at C8 and solder.

Find two (2) 470 pF multilayer caps (471).

3. Install 470 pF at C13 and solder.

4. Install 470 pF at C16 and solder.

Find two (2) 820 pF multilayer caps (821).

5. Install 820 pF at C19 and solder.

6. Install 820 pF at C20 and solder.

Find two (2) 1000 pF multilayer caps (102).

7. Install 1000 pF at C7 and solder.

8. Install 1000 pF at C14 and solder.

Locate three (3) 10 uH molded chokes (brown-black-black-gold or silver).

9. Install a 10 uH choke at RFC1 and solder.

10. Install a 10 uH choke at RFC2 and solder.

11. Install a 10 uH choke at RFC3 and solder.

Locate the T37-2 toroid form, a donut-shaped part about 3/8" in diameter and color-coded red. Also, find the #24 enameled coil wire provided with your kit.

12. Wind twenty-two (22) turns of #24 wire onto the T37-2 form. Turns are counted *inside* of the form, and each turn is pulled tight before winding the next. Turns for the 80 meter coil should fill the entire form.

13. Trim coil leads to 1/2" and tin with solder.

14. Install the coil at L1 and solder.

15. Locate the 3.579 MHz crystal (metal can, two wire leads). Install at Y1 and solder.

This completes stage 2 construction of the **VEC-1280K 80-meter kit**. After checking for errors, you may now move on to the final stage of construction.

Phase 8: Completing your Kit

During this final stage of construction, you'll install the remaining larger components. From now on, the finished product will take shape very quickly!

- 1. Locate two (2) DPDT push-button switches (six pins). Install one of these at SW1, making sure the switch pins are fully seated and the switch body is level. Solder in place.
- 2. Install the second DPDT push-button switch at SW2.
- 3. Locate two (2) RCA PC mounted jacks. Install one of these at J3, making sure the three metal tabs are seated all the way into the board. Solder the tabs and center-pin.
- 4. Install the second RCA jack at J4 and solder.
- 5. Locate the 3.5 mm mini-phone jack. Install at J1, making sure the plastic case is square to the edge of the PC board and flat against its surface. Solder all pins.
- 6. Locate the 2.1 mm DC power jack. Install at J2, seating the case flat against the surface of the PC board. Twist each solder tab slightly to secure the jack place, and solder all three.

Find the plastic-encased variable capacitor. This is the transmitter's VXO tuning control (C5).

Locate the small strip of double-sided tape. Also, find two of the heavy-gauge leads removed from the 1N4007 diodes. These items will be used to secure C5 in place.

- 7. Using scissors or a hobby knife, cut a 1/2" by 3/4" square of double-sided tape. Install this within the box printed at C5 on the PC board (see diagram).
- 8. To orient the variable capacitor for installation, use the following diagram. There should be a ground tab to the left and right of the shaft. At the rear of the cap, a solder tab will protrude from the case at lower left. When the cap is positioned as shown, press it down onto the tape to secure it in place.

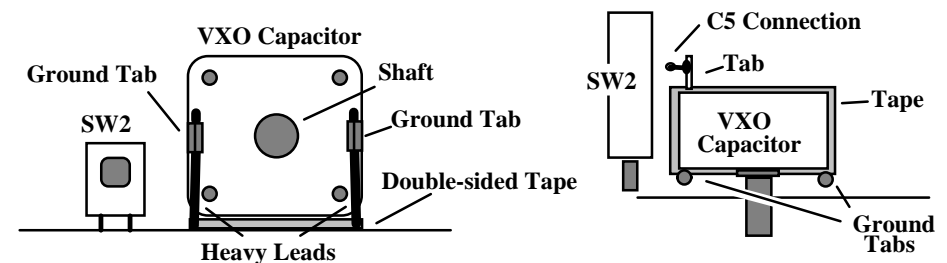

- 9. Install two (2) heavy leads (from the 1N4007 diode) from the ground tabs to the pads in front of the VXO capacitor on the PC board. Solder each lead at both ends. The combined holding action of the two-sided tape and the ground leads should anchor the cap firmly in place. Rotate the cap through its range--the capacitor should not shift position.
- 10. Find a resistor lead clipping. Install this between the unused pad next to SW2 and the nearest solder-tab on the rear of C5. Solder at both ends.
- 11. Find the TO-5-type clip-on heat sink for Q4. Slip this over the 2N3053 transistor.
- 12. Find the 1/2" tuning shaft extension. Screw it into the main tuning capacitor shaft. Back off about two turns to open a gap between the two shafts. Allow a small drop of contact cement to flow into gap and onto threads. Immediately screw shafts together until snug and allow glue to set. (*Do not over-tighten or threaded portion of the shaft extension will break!*)

Congratulations--this concludes construction your QRP transmitter, and you deserve a well-earned break! When you come back, be prepared to give your work a thorough "QC" quality-control check before moving on to the "Testing and Alignment" section.

PC Board Inspection: Before applying power to your kit, give it a thorough QC (quality control) inspection. This will help you find inadvertent assembly errors that might prevent the radio from working or cause damage to sensitive parts. Follow this procedure:

- Compare parts locations against the Parts Placement Diagram. Was each part installed where it is supposed to be? Was the correct value used? Start at one side of the board and work your way across in an organized pattern.
- Inspect the solder side of the board for cold-solder joints and solder bridges between tracks or pads. Use a magnifying glass to obtain a clear view of the track area. If you suspect a solder bridge, hold the board in front of a bright light for a better view. All joints should be smooth and shiny, indicating good solder wetting and flow. Resolder any beaded or dull-appearing connections.
- Finally, check the electrolytic capacitor and diodes for correct polarity. Does the plus (+) polarity symbol on the part agree with the pictorial and with the pattern on the PC board? Is the banded end of each diode positioned correctly? Were Q1-Q4 all installed correctly?

Be sure to correct all errors before moving on. If a careful inspection revealed that everything is A-OK, you're now ready for the moment of truth!

TESTING AND ALIGNMENT

Tools And Materials Required For Testing:

Your VEC QRP-CW Transmitter is a "no-tune" design that has no adjustable alignment trimmers or coils to set up prior to operation. If it's built correctly, it will work. For initial testing, you'll need the following items:

1. **50-ohm dummy load:** Any 50-ohm *non-inductive* resistor capable of handling up to two watts will provide a satisfactory transmitter load. If a dummy load isn't available, you can make one using two (2) 100-ohm 1-watt metal oxide resistors (Radio Shack 271-152). These should be connected in parallel across a standard RF connector that will plug into your RF wattmeter or VSWR bridge.

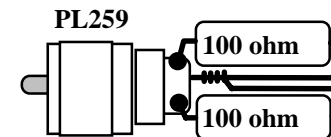

2. **Power Meter:** In addition to a dummy load, you'll need a calibrated RF-power meter with a low-power range to measure the output of your transmitter. This provides your best indication as to whether or not the transmitter circuitry is working properly. If you don't have access to a calibrated watt meter, an inexpensive CB-type VSWR meter will provide a relative indication of transmitter output.
3. **Telegraph Key:** Your transmitter's keying circuit will work with any manual or semi-automatic key, and with most electronic keys. To plug into the key jack, you'll need a standard 1/8" (3.5-mm) stereo phone plug (Radio Shack 274-284). Ground (or common) is connected to the plug's outer sleeve, and the key line is connected to the plug's tip. A monaural type 1/8" plug will also work.

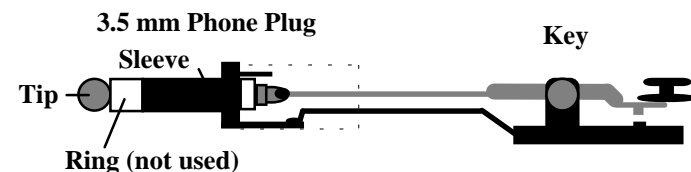

4. **Power Supply:** Your transmitter will operate from any well-regulated 12-14 volt 500-mA DC (or 0.5 A) power source. Avoid using poorly-regulated or

inadequately-filtered 12-volt wall-adapters. These can cause ripple on the CW note, and may even damage your kit if the unloaded output exceeds 15 volts. A fully-charged 12-volt battery is a suitable power source, although transmitter output may be reduced slightly (RF output is specified at 13.8 volts).

The power jack supplied with your kit is a common 2.1-mm DC connector. The mating 5.0-mm OD x 2.1mm ID plugs are available at your local Radio Shack store (274-1567). Take care not to reverse-connect the power leads. ***The plus (+) or red power supply lead connects to the center pin, and the minus (-) or black lead connects to the outer sleeve.*** If your power wires aren't color-coded, confirm polarity with a voltmeter before installing the plug!



Important Note: In case of accidental reverse-power connection, your transmitter is protected against major damage by a "crowbar" diode (D1). However, activation will blow a "trace fuse" etched onto the circuit board next to the power connector. This must be replaced by a thin wire or a pig-tail type fuse before your kit will operate again (see "In Case of Difficulty").

5. RF Cables: Patch cables are needed to interconnect the transmitter to your wattmeter and receiver. You may make these up using RG-174 "mini-coax" or RG-58. Install a RCA phono plug at the transmitter end, and the appropriate connector at the opposite end.

If you already have patch cables, you may purchase 50-ohm coaxial transition adapters that fit RCA jacks from your local Radio Shack store. For BNC patch cables, use catalog number 278-250. For a direct PL-238 transition, use a "scanner adapter" plug, catalog number 278-208. This is a UHF to "Motorola-jack" type adapter that requires only minor modification to work with RCA jacks. To modify, shorten the protruding center pin so that it extends about 1/8" beyond the outer sleeve of the plug using a fine-toothed hack-saw or hobby saw. De-burr and round off the end. The modified transition will now plug directly into RCA jacks.

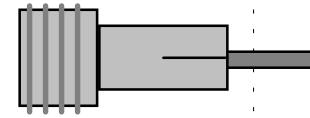

Cut pin here and round off end.

Test Set-up and Procedure:

To test your transmitter, set up as shown in the following diagram. Make sure the PC board is on a clean non-metallic surface and that the test area is free of lead-clippings, hardware, and other conductive debris that could get under the board and cause a short circuit. Before connecting the power supply, make sure the transmitter power switch (SW1) is turned OFF (out position). The crystal selector switch (SW2) should be set for Y1 (out position). *No direct connection should be made to your receiver during the initial test.* However, your station receiver should be turned on, placed in the CW mode, and tuned in to the transmitter's approximate frequency. If any of the steps outlined below fail, refer to the "In Case of Difficulty" section of the manual.

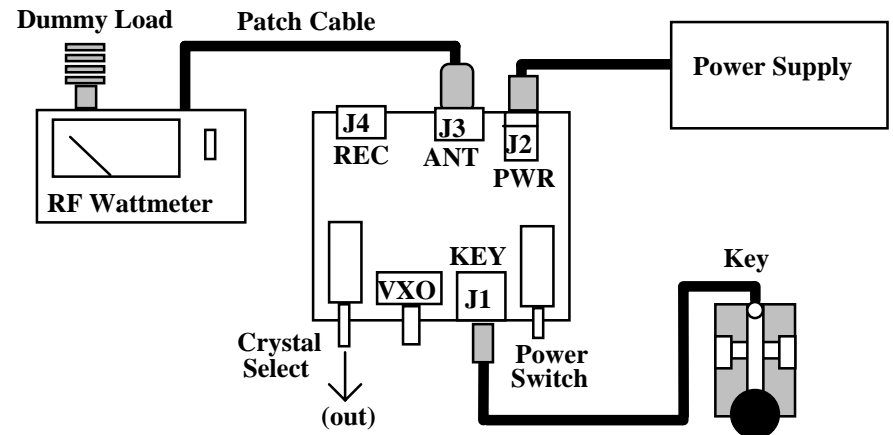

1. Press *power switch* SW1 to ON. There should be no RF output indication.
2. Confirm the *crystal select switch* is in the *out* position, selecting crystal Y1.
3. Press the key. The power meter should indicate output of 1 watt or more.
4. Release the key--the output power should drop to zero.
5. Press the crystal select switch to the *in* position and key. There should be no output.
6. Return the crystal select switch to the *out* position.

If you don't have access to a wattmeter, a standard 5 mm LED may be used to give a rough indication of normal power output from the transmitter. When using this test, however, the transmitter's antenna jack *must* be terminated with a 50-ohm dummy load. Connect the LED across the terminated antenna jack and key the transmitter. The LED should illuminate brightly at normal power output (do not attempt this test with higher power transmitters, or LED destruction may result).

7. Key the transmitter and find its signal with your station receiver.

8. Monitor the CW note for severe chirp, 60-Hz ripple, or key clicks.

The presence of a "buzz" on the CW note *may* indicate poor power supply filtering, *or* may simply mean there's a ground-loop in your test set-up that won't affect your signal over the air. Obtain on-air reports to confirm hum or ripple observations.

9. Key and tune the VXO capacitor. The transmit frequency should shift.

The *amount* of frequency shift you obtain will depend upon the band of operation. On 20 meters, a tuning range of 7-kHz or more is possible. On 80 meters, as little as 1.5-2 kHz shift is typical due to the lower frequency of the transmit crystal.

10. To test the receive side of the T/R switch, connect a 5-mm LED across J4 and key. If the LED *doesn't illuminate* when the transmitter is keyed, the T/R switch is working and it should be safe to connect receivers to the receiver jack. The transmitted signal should appear approximately -25 dBc at the receiver jack.

This concludes the testing phase of construction. If your VEC QRP-CW Transmitter Kit made the grade, you're ready to connect a receiver and an antenna for some serious QRP operating! If it didn't pass, please refer to the "In Case of Difficulty" section for some suggestions that may help you isolate and cure the problem. If you purchased the VEC cabinet for your kit, now is a good time to install your circuit board in it.

OPERATING INSTRUCTIONS

Connecting up the VEC QRP-CW Transmitter:

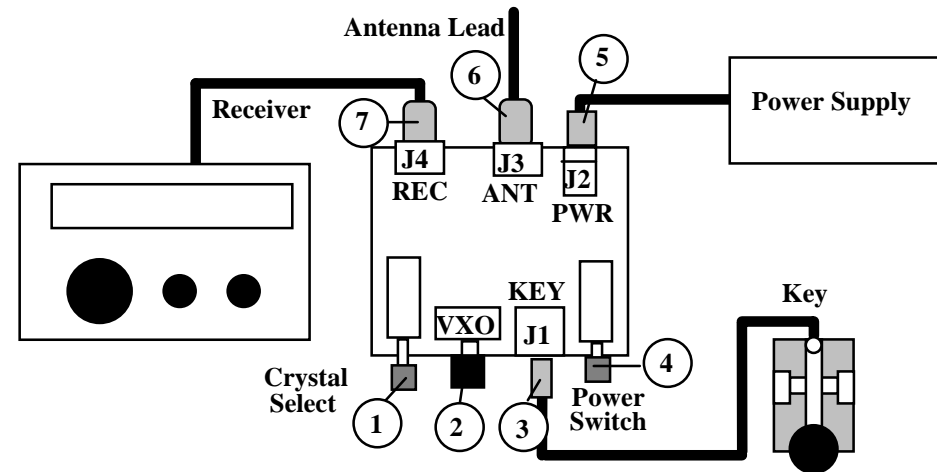

1. **Crystal Select:** Selects calling frequency (Y1) and optional crystal (*not provided*).
2. **VXO Tune:** Varies oscillator above and below crystal's "cut" frequency.
3. **Key Jack:** 1/8" mini-jack, accepts manual keys and most electronic keys.
4. **Power Switch:** Applies power to transmitter circuitry.
5. **Power Jack:** 2.1x 5.0-mm, (+) to center (-) to sleeve, 12-14 V @ .5A
6. **Antenna Jack:** RCA, >1watt of RF into 50-ohms, 3:1 VSWR or less.
7. **Receiver Jack:** RCA, routes antenna to receiver via T/R switch.

Receiver Hook-up: You may patch most receivers directly into your VEC QRP-CW Transmitter's *receiver* jack without risk of damage. Transmitter output is typically around + 32 dBm and the energy reaching your receiver through the T/R switch is normally 25 dB lower, or about +7 dBm. This is a very strong signal, but a high-quality receiver with a wide AGC range can usually handle it without blasting out the speaker! If you are able to leave the receiver on during transmit, you'll enjoy the benefit of full QSK operation. This means you'll be able to monitor incoming signals--and listen to your own outgoing signal--simultaneously. If your receiver has an attenuator switch, turning it on will help reduce the effects of overload. By the same token, if your receiver has a pre-amplifier, you should turn it off. Receivers unable to limit speaker or headphone volume over a wide range of signal inputs must be turned down or switched to standby mode while you send.

QRP Antennas: QRP operation requires a good antenna, but you don't need stacked beams at 100' to get the job done! Most QRP operators use modest wire antennas that have been carefully installed and tuned for minimum VSWR. It's best to avoid compromised or severely shortened designs along with long lossy feedlines and inefficient matching schemes. Like most of today's solid-state radios, your VEC QRP-CW Transmitter uses a "no-tune" broadband output network designed to match into 50-ohm loads. While it can tolerate a wide range of mis-matches, you'll get more usable power and better harmonic filtering with a low VSWR load.

Experience has shown that a full-sized 1/2-wave dipole or sloper installed as high as possible is hard to beat. The following chart suggests dipole wire lengths for various CW sub-bands. These dimensions are sensitive to ground conditions and near-by objects, so you may need to prune the length slightly to obtain minimum VSWR at your location. Information is also provided for adding a very low cost "choke" balun to your installation. A balun helps eliminate unwanted feedline radiation on transmit and noise pick-up on receive. Heavy-weight or premium cables are not required for QRP stations, and inexpensive RG58 is usually sufficient to do the job. The lighter your coax, the higher you can pull the center of your antenna!

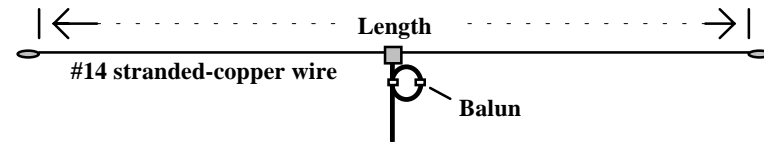

Band	MHz.	Length	Per-side	Balun
80	3.6	130' 0"	65' 0"	20'
40	7.1	66' 0"	33' 0"	14'
30	10.1	46' 4"	23' 2"	10'
20	14.05	33' 2"	16' 7"	8'

Balun consists of RG58 coiled 10" in diameter and held with tape or plastic tie-wraps

For additional antenna information on a wide variety of HF antennas, consult the ARRL Antenna Handbook, a publication of the American Radio Relay League in Newington, Connecticut.

QRP Operating Tips: Most QRP DXers agree the "hunt-and-pounce" method works best. Rather than spending a lot of time calling CQ, look for other stations calling CQ and answer them. Also, call stations that have just completed a QSO and signed. When you *do* call CQ, you can usually expect more replies around the QRP calling frequency where operators anticipate weaker signals. Finally, never hesitate to call a weak station--he (or she) may also be operating

QRP or may simply have a poor transmitting antenna! You'll soon discover world-wide QRP contacts are routine. A growing legion of CW operators have QRP-DXCC certificates hanging on the wall to prove it!

IN CASE OF DIFFICULTY

Your VEC QRP-CW Transmitter has been thoroughly field-tested and is known to be reliable and "forgiving" of construction errors. If you have difficulty with your unit, the cause may be something as simple as a broken cable or a defective power source. In most cases, you will be able to find the problem with some organized troubleshooting. Begin your search with this checklist of symptoms and remedies:

Does not power up: Check the condition of your power source and connecting cable. Also, check supply polarity, direction of D1, and inspect the fuse trace near J2.

Does not key: Check your key and plug. Also, check circuitry around Q1 and Q2 for construction errors. Make sure Y1 is installed correctly and crystal-select switch is out. Listen for the transmitter signal with a receiver to see if Q2 is working.

Weak Signal, no measurable output: Check for construction errors around Q3, Q4. Also, check position of diodes D2 and D3. Vcc should be present on case of Q4.

Low Transmitter Output: Check values of C13, C14. Inspect circuitry around Q4, D2, RFC4, etc. (transmit side of T/R switch). Also, check values of C19, C20, and count the number of turns on L1.

Severe chirp or key-clicks on signal: Check component values around Q2. Check values of C1, R1, C2.

Transmitter remains on when unkeyed: May be caused by parasitic oscillation or insufficient loading of Q1. Check all RFCs for correct value, location, and continuity. Check circuitry around Q3, Q4 for errors. Also, is a load connected to transmitter?

LED lights at J4 (receiver jack) when transmitter keyed: Check around D3 for construction errors. Also, test D3 using "diode test" function on DVM.

VXO cap fails to shift frequency: Check RFC1, connections to C5.

Blown Crowbar Fuse: This is usually caused by reverse power connection or by a direct short circuit from Vcc to ground on the PC board. The etched copper fuse may be replaced by a small 1-A pigtail fuse or by a short length of #32 enameled wire. Your kit will not power up until this is replaced.

Voltage Analysis: Voltage analysis is a great way to pinpoint circuit problems. To do this, you'll need a voltmeter or DVM. Clip the black lead (-) to ground and use the red (+) probe to check the DC voltage at each transistor lead. Before you begin, *disable oscillator Q2 by switching the crystal select switch "in"*. This will remove the crystal from the oscillator circuit and prevent the transmitter from generating RF while you're attempting to make DC voltage measurements. Compare your readings against the chart below. They should agree to within 10-15%. If you observe one or more "bad" readings, this may mean the device you're checking is blown--or that an incorrectly-installed part is lurking near-by. Try using the transmitter's schematic diagram to trace out the exact cause of the problem.

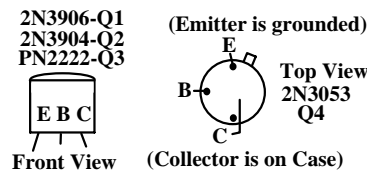

Important Note: *Crystal Select Switch MUST be pushed in to disable oscillator. Unit must not generate RF during these checks!*

VOLTAGE CHART

	Standby			Key-Down		
	E	B	C	E	B	C
Q1	13.8	13.2	0	13.8	13.0	13.6
Q2	0	0	0	5.7	6.3	12.6
Q3	0	0	13.8	0	.7	7.5
Q4	0	0	13.8	0	0	13.8
D2	(banded end) 2.2			(banded end) 12.9		

If these checks fail to uncover the problem, repeat the "QC" check one more time. Service records show that, for most malfunctioning kits, outright component failure is relatively rare. In most cases, the culprit is a misplaced part, reverse-polarized capacitor or diode, improperly installed transistor, or a faulty solder connection! If, despite your best effort, you cannot solve a problem with your radio, kit repair services are available through Vecronics. See the warranty on the inside front cover for complete instructions.

THEORY OF OPERATION AND SPECIFICATIONS

Technical Circuit Description:

The VEC QRP-CW Transmitter is a simple three-stage oscillator/amplifier with no tune-up requirement. Q1 is keyed on by logic-low input from a mechanical key or electronic keyer to power oscillator Q2. Q1 also supplies turn-on bias to driver Q3 and T/R switching diode D2. Q2 is a crystal-controlled series-tuned colpitts oscillator modified for VXO operation (RFC1, C5). SW2 selects an optional second crystal. Q3 drives PA Q4 through capacitive divider C13, C14. Q4 is a simple class-C amplifier that remains powered at all times, but only draws current when RF excitation is present. In transmit mode, the antenna line is routed to Q4 via diode switch D2. In receive mode, it is routed to the receiver port via D3. A pi-section low-pass filter (which includes C16) provides impedance matching and harmonic suppression between Q4 and the 50-ohm antenna port. CW output averages +32 dBm with -25 dBc of antenna-port isolation.

Specifications:

RF Power Output:.....1.25 watts at 14 MHz

Suppression:35 dBc or better

Receiver Isolation:.....-25 dBc

VXO tuning range:8 kHz at 14 MHz (less at lower frequencies)

Stand-by-current:10-15 mA

Transmit current:250-350 mA at 13.8 Volts DC

ENCLOSURE

Vectronics has designed a matching enclosure just for your *CW Transmitter Kit*. The matching enclosure is an all metal box which includes knobs, hardware, decals, and rubber feet. **Enclosure model: VEC-1200KC.**

To install your *CW Transmitter* in the VEC-1200KC matching enclosure follow these instructions (***read all instructions before beginning ... take your time***):

1. Find the front panel decal and rear panel decal; separate using scissors. Be sure to leave excess decal material around the edges. Put the rear panel decal on first. This is done by: **a.)** Remove all debris and oil from the chassis. This should be done using a piece of cloth and alcohol. **b.)** Remove the crack and peel to expose the adhesive. **c.)** Place the decal on the rear panel without securing it completely. **d.)** Gently rub the alignment circles with your finger--if the circles are centered in the enclosure holes (also check the corner alignment marks) secure the decal by rubbing and removing all air bubbles. **e.)** If the alignment circles are not centered, adjust the decal accordingly, then secure. **f.)** Use a penknife, or small Exacto™ knife, to cut away the unused edges (*cut from the adhesive side*) and cut out the component holes (*cut from the description side*). **g.)** Repeat this procedure for the front panel.
2. Next, install the two L-brackets on the chassis using two of the 3/16" screws. The longer side of the L-bracket *must be* connected to the chassis using the two holes centered on each edge of the enclosure. Refer to the diagram on the next page for location and orientation.
3. Install the four 1/2" mounting screws next. Insert the screws, from the bottom, through the four holes at each corner of the chassis.
4. Place the four 3/16" round spacers on the mounting screws.
5. Now insert the PC board. This must be done by: **a.)** Insert the front of the PC board at an angle so the controls enter their respective holes. **b.)** Push down on the rear of the board. Make sure the mounting screws align with the mounting holes in the PC board before pushing.
6. Use the four hex nuts to secure the PC board. Be certain all appropriate components are centered with the enclosure holes before tightening.
7. Find the knob and switch caps. Align the red switch cap with SW1 and push it on. If it is difficult to push on, then rotate it 90° and try again. Repeat procedure for SW2 using the black switch cap. Now place the knob on C5. You may need to loosen the set screw. Align appropriately then tighten the set screw.
8. Install the top now. Use the two remaining 3/16" screws for securing the top to the L-brackets. Make sure the L-brackets are aligned properly.
9. Finally, place the four rubber feet on the bottom of the enclosure at the corners.

