

# Comprehensive Soldering Course Kit

model VEC-1500K

*This is the most comprehensive home-study soldering course available!*

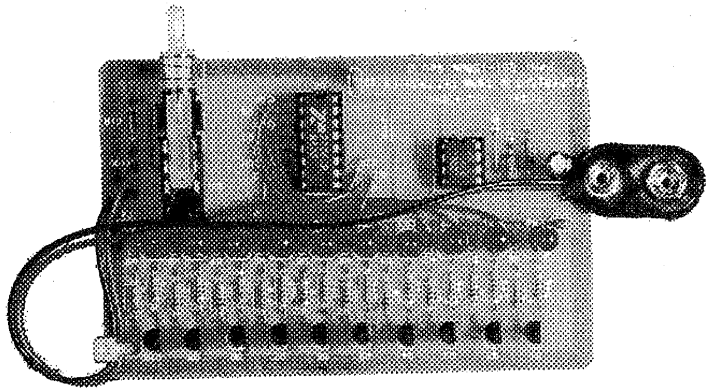

- This *professional-grade* soldering course was designed for schools and individuals. Includes theory, quizzes, PC board and components for soldering practice. Results in professional soldering skills and fun blinking LED project.
- This course covers all of the latest tools, techniques and materials you'll need for "through-hole" style PC board assembly and repair. When you complete this course you'll be ready to tackle a wide range of jobs on the bench and in the field.
- Short, concise lessons cover topics like solders and fluxes, product safety, soldering irons, circuit boards, component handling and much, much more.

#### Skill Level 1

*Simple:* Calls for a few basic tools -- a soldering iron, cutters, pliers, wire-strippers and a small screwdriver. Doesn't require test equipment for final adjustment or tuning.

*Great Educational tool!*

# VECTRONICS

*High-performance electronic kits . . . fun to build and use!*

## IMPORTANT WARRANTY INFORMATION! PLEASE READ

**Return Policy on Kits When *Not* Purchased Directly From Vectronics:** Before continuing any further with your VEC kit check with your Dealer about their return policy. If your Dealer allows returns, your kit must be returned *before* you begin construction.

**Return Policy on Kits When Purchased Directly From Vectronics:** Your VEC kit may be returned to the factory *in its pre-assembled condition only*. The reason for this stipulation is, once you begin installing and soldering parts, you essentially take over the role of the device's manufacturer. From this point on, neither Vectronics nor its dealers can reasonably be held accountable for the quality or the outcome of your work. Because of this, Vectronics cannot accept return of any kit-in-progress or completed work as a warranty item for any reason whatsoever. If you are a new or inexperienced kit builder, we urge you to read the manual carefully and determine whether or not you're ready to take on the job. If you wish to change your mind and return your kit, you may--but you must do it *before* you begin construction, and within ten (10) working days of the time it arrives.

**Vectronics Warrants:** Your kit contains each item specified in the parts list.

**Missing Parts:** If you determine, during your pre-construction inventory, that any part is missing, please contact Vectronics and we'll send the missing item to you free of charge. However, *before* you contact Vectronics, *please look carefully* to confirm you haven't misread the marking on one of the other items provided with the kit. Also, make certain an alternative part hasn't been substituted for the item you're missing. If a specific part is no longer available, or if Engineering has determined that an alternative component is more suitable, Vectronics reserves the right to make substitutions at any time. In most cases, these changes will be clearly noted in an addendum to the manual.

**Defective Parts:** Today's electronic parts are physically and electrically resilient, and defective components are rare. However, if you discover an item during your pre-construction inventory that's obviously broken or unserviceable, we'll replace it. Just return the part to Vectronics at the address below accompanied with an explanation. Upon receipt, we'll test it. If it's defective and appears unused, we'll ship you a new one right away at no charge.

**Missing or Defective Parts After You Begin Assembly:** Parts and materials lost or damaged *after construction begins* are not covered under the terms of this warranty. However, most parts supplied with VEC kits are relatively inexpensive and Vectronics can replace them for a reasonable charge. Simply contact the factory with a complete description. We'll process your order quickly and get you back on track.

**Factory Repair After You Begin Assembly:** *Kits-in progress and completed kits are specifically excluded from coverage by the Vectronics warranty.* However, as a service to customers, technicians are available to evaluate and repair malfunctioning kits for a minimum service fee of \$18.00 (½ hour rate) plus \$7.00 shipping and handling (prices subject to change). To qualify for repair service, your kit must be fully completed, unmodified, and the printed circuit board assembled using rosin-core solder. In the event your repair will require more than an hour to fix (or \$36.00, subject to change), our technicians will contact you in advance by telephone before performing the work. Defective units should be shipped prepaid to: Vectronics

300 Industrial Park Road  
Starkville, MS 39759

When shipping, pack your kit well and include the minimum payment plus shipping and handling charges (\$25.00 total). No work can be performed without pre-payment. Also, provide a valid UPS return address and a day time phone number where you may be reached.

# Table of Contents

<b>INTRODUCTION .....</b>	<b>1</b>
<b>VECTRONICS SOLDERING COURSE LESSONS.....</b>	<b>2</b>
LESSON 1	
Solder Alloys And Wire.....	2
LESSON 2	
Kinds of Flux .....	6
LESSON 3	
Soldering--Health and Safety .....	11
LESSON 4	
Soldering Irons.....	13
LESSON 5	
Soldering Iron Tips .....	19
LESSON 6	
Tip and Iron Maintenance .....	21
LESSON 7	
Soldering Applications.....	24
LESSON 8	
Component Handling and Preparation .....	32
LESSON 9	
Desoldering for Repair or Replacement.....	36
<b>VECTRONICS SOLDERING COURSE QUIZZES .....</b>	<b>39</b>
Lesson 1 Solder Alloys and Wire.....	39
Lesson 2 Kinds of Flux .....	40
Lesson 3 Soldering Health and Safety.....	41
Lesson 4 Soldering Irons.....	42
Lesson 5 Soldering Iron Tips .....	43
Lesson 6 Iron and Tip Maintenance .....	44
Lesson 7 Soldering Applications.....	45
Lesson 8 Component Handling and Preparation .....	46
Lesson 9 Desoldering for Repair and Replacement .....	47
Answers to quizzes.....	48

**VECTRONICS SOLDER COURSE LAB ..... 49**

- Parts List ..... 49
- Parts Placement Diagram ..... 50
- Step-By-Step Assembly Instructions ..... 50
- Operating Instructions ..... 60
- In Case of Difficulty ..... 60
- Theory of Operation ..... 61
- Specifications ..... 61
- Schematic ..... 62

# INTRODUCTION

Like technology itself, the art and science of soldering has advanced a great deal over the years. This course covers all the latest tools, techniques, and materials you'll need for "through-hole" style PC board assembly and repair. By the time you complete it, you'll be ready to tackle a wide range of jobs on the bench and in the field.

Before you begin work, take a few minutes to browse through the course manual. As you will see, this course contains three main sections. In the first main section, you'll find nine short and detailed lessons that cover topics like solders and fluxes, product safety, soldering irons, circuit boards, component handling, and much more. The next section contains quizzes to reinforce the material you've read in each lesson. Be sure to use this section; it can be a valuable study aid.

In last section of this course, you'll find step-by-step instructions for the laboratory portion of the course. This exercise requires a well-lighted and uncluttered workspace along with some basic soldering tools and materials. Make a list of the items you'll need to complete the lab, and round them up ahead of time.

To avoid "information overload", limit reading to one lesson per study session. The more carefully you work, the more you'll remember later on--when it really counts.

# VECTRONICS SOLDERING COURSE LESSONS

## LESSON 1

### *Solder Alloys And Wire*

A few short years ago, choosing the right type of solder was easy--you bought "rosin core" for electronics and "acid core" for plumbing. These days, it's a little more complex! Distributors now offer a wide range of solder alloys, wire sizes, core types, and fluxes--not to mention many supplemental soldering aids and chemicals. While all of these options let you select products especially matched to every job, the choices can get confusing. In this session, we'll survey a range of solder products used for electronic bench work--and look at how to use them safely.

**Properties and Characteristics of Common Solder Alloys:** Over time, solder has proven to be the most efficient and economical way to connect individual electronic components together into complex patterns of circuitry. To find out why it works so well, we'll start with a definition. The McGraw-Hill Electronics Dictionary defines "solder" this way:

*Solder (1.) An alloy that can be melted at a fairly low temperature, for joining metals which have much higher melting point. An alloy of lead and tin in approximately equal proportions is the solder most often used for making permanent joints in electronic circuits.*

Solder is unique because it's a solid at room temperature, but melts easily to bond with other metals. Once cool, it provides a *strong mechanical joint* to hold components in place, and it provides a *low-resistance electrical path* for efficient electrical flow. Best of all, the soldering process is *reversible*. If you want to replace a component or move a wire later on, you can do it. Little wonder soldering is the process of choice for a wide range of assembly tasks ranging from the laboratory bench to the manufacturing production-line!

**The Three States of Solder:** Solder does more than simply "melt" as it gets hot. Solder alloys exhibit three distinct physical *states* during the heating and cooling process. These are:

Solid State: At room temperature, solder behaves as a "frozen" metal--it's solid and mechanically stable. The exact temperature where solder begins to "thaw" depends upon the mixture of metals in the alloy. Most electronic solders change state at between 360 and 420 degrees F.

Plastic State: As solder begins to "melt", it first changes into a pasty, unstable, soft material. If a cooling solder joint is vibrated or moved while in the plastic state, the resulting connection will appear dull, grainy, and the joint may fracture. To prevent fractures, most electronic solders are specially formulated to minimize their "plastic-state" temperature range. This makes the transition from a liquid to a solid more rapid.

Liquidous State: As temperature rises, solder changes from a plastic paste to a thick, syrupy, molten liquid. This is called the *liquidous* state. When solder is in the liquidous state, it can flow, "wet", and adhere to many electrically conductive metals such as copper, tin, silver, and brass. However, electronic solders don't adhere to *all* conductive metals. It won't stick to aluminum, for example. The metals it adheres to are called *solderable metals*.

**Composition of Solder Alloys**: We've said that most solder alloys consist of *near-equal mixtures of tin and lead*. Normally, pure tin melts at 450-degrees F and pure lead melts at 621 degrees F. However, when we combine the two into an alloy, the melting point becomes lower. The actual temperature depends upon *percentage of tin to lead--as measured by weight*. The two alloys used most commonly for electronic solder are:

60/40 Alloy: Solder containing 60% tin and 40% lead begins to melt at around 374 degrees F with a plastic range of 13 degrees F. This mix provides a relatively low melting point, which helps to limit thermal stress on sensitive electronic components. The 60/40 alloy also provides superior *wetting* on solderable metals. "Wetting" refers to liquidous solder's ability to spread over the surface of another metal and adhere to it. In addition to superior wetting, 60/40 solder has a moderate ability to *bridge short gaps* between metal surfaces. "Gapping" is especially useful for assembly jobs where contact between conductive surfaces may be loose or incomplete.

63/37 Solder: Solder containing a mixture of 63% tin and 37% lead begins to melt at around 364 degrees F--slightly lower than the 60/40 alloy. The 63/37 alloy is unique because it has an extremely narrow plastic-state temperature range--only a degree or two. Because of this characteristic, the transition from a liquidous state to a solid state is virtually instantaneous. Alloys that "set" this quickly during cooling are called *eutectic* (you-tech-tic) solders. The 63/37 alloy exhibits less gapping and less movement from contraction during cooling.

Both alloys are extremely popular for general-purpose hand soldering. The 60/40 alloy generally works better for single-sided circuit board assembly, hand-wiring, larger connector installations, and any other application where superior wetting or moderate gapping is beneficial. The 63/37 alloy works better for assembling crowded multi-layer PC boards and for making surface-mount repairs. These are applications where gapping could cause unwanted short-



circuits and where joint contraction might move tiny surface-mount parts out of position during cooling. As a rule, however, either type may be used interchangeably for most bench applications.

**Specialty Solders:** In addition to the popular 60/40 and 63/37 alloys, electronics distributors now offer a variety of *specialty* solders. Specialty solders have unique properties that are well matched to specific electronic applications. Here are some of the more popular types:

2% Silver Solder: This lead/tin/silver alloy provides a somewhat higher melting point, improved conductivity, and increased strength over 60/40 and 63/37 solders. The 2% alloy works well where added joint durability is needed, or in applications where high operating temperatures and strong electrical currents may work together to melt conventional solders.

Low-Temperature Solder: This alloy melts at a significantly lower temperature than 63/37 or 60/40, reducing the risk of thermal damage to unusually heat-sensitive electronic components. The most popular low-temp formula combines a mix of 43% tin, 43% lead, and 14% bismuth into an alloy that melts at 295-325 degrees F. Some low-temperature solders are highly toxic, so be sure to read instructions carefully before using them.

Lead-free Solder: Lead is a toxic substance that accumulates in the body. Because of this, leaded solders can't be used in some applications or handled by people who are medically at-risk for lead contamination. As an alternative, Tin/antimony solder alloys provide a low-toxicity bond for electronic applications where environmental protection or medical safety is important. A tin/silver alloy may also fulfill this requirement.

### **Commonly Available Forms of Solder**

Wire solder comes in a variety of standard diameters and core configurations. Most have one or more hollow cores filled with flux. Flux is an essential chemical agent used to free metal surfaces of oxides during heating. Dispensing flux via a hollow core in the solder wire controls the delivery rate and ensures uniform flux dispersion over the connection.

**Solder Wire Size:** Standard wire diameters for solder range from a thick .125-inch (11 gauge) wire to a hair-fine .010-inch (31 gauge) wire. Here is a list of standard solder diameters shown:

<u>Diameter</u>	<u>Gauge</u>
.125"	11
.093"	13
.062"	16
<u>Diameter</u>	<u>Gauge</u>

.050"	18
.040"	19
.031"	21
.025"	23
.020"	25
.015"	28
.010"	31

As you can see, there's a lot of them! However, most distributors carry only a few of the more popular sizes. As a rule of thumb, solder manufacturers recommend using the *largest wire size with the highest flux percentage practical* to ensure good iron tinning and adequate flux delivery. In general, when solder wire is too large for the job, you'll have difficulty controlling how much melted solder is applied to the joint. When the wire is too small, you'll have difficulty feeding enough solder onto the connection with a single well-controlled hand movement.

In practice, many technicians like to keep a roll of .020-inch 63/37 for intricate surface-mount work and a roll of .031 or .040-inch 60/40 for general bench use. Large high-power component assembly require a thicker solder--.062-inch for example--to provide rapid coverage of the joint area. Ultimately, the ideal wire size depends on the task and on your personal preference.

**Type of Core:** In addition to the ten standard wire diameters, solders also come in three core types--single core, multi-core, and solid core. *Single-core solder* has one hollow cavity at its center filled with flux. *Multi-core solder* has several smaller-diameter flux cavities clustered around the center. The manufacturers of multi-core products claim better flux dispersion, but--in practice--both single and multi-cores work acceptably well. *Solid-core solder* has no flux cavity. When using solid-core solders, you must apply a flux paste to connections by hand using a brush or syringe.



Single Core



Multi-Core



Solid

**Size of Core:** Not all flux cores are the same size. The *core-size* of wire solder is especially important because it controls the *amount* of flux delivered to each connection. Core size may be specified as a *number* (Kester No. 66), a generic *name* ("regular"), or a *flux percentage* (3.3%). Flux percentage is based on the weight of the flux as compared to the weight of 60/40 alloy. Three "manufacturer's standard" core sizes are shown below:

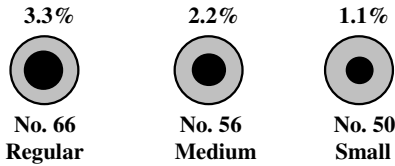

For general bench work and field repairs, "regular-core " (3.3%) solder delivers the most flux, providing the fastest chemical action and best preparation of metal surfaces. For hand assembly operations where metals are highly solderable and surfaces pre-cleaned, 2.2% or even 1.1% solder will do the job--and leave less residue behind for clean-up.

It's always important to check core size when you select a roll of solder. Solder wires with low flux delivery may perform poorly on unprepared surfaces, and may also cause your iron to "de-wet". De-wetting (or loss of tinning) is a condition where solder no longer adheres to the tip because there isn't enough flux available to keep it free of oxides. If forced use solder with a medium or small core for general bench work, apply supplemental flux to each connection before heating. This will protect your iron and to ensure adequate joint preparation.

## LESSON 2

### *Kinds of Flux*

Flux is essential for successful hand-soldering. However, not all fluxes have the same chemical composition or working characteristics. Different formulations do the job in slightly different ways. In this section, we'll take a closer look at what flux does, and cover the various types of flux in common use for hand soldering.

**How Flux Works:** When exposed to air, most "raw" solderable metals quickly attract oxygen molecules and form a layer of oxide. Once oxide forms, the surface is rendered chemically "passive". This means no molecular bonding sites are available for combining with other metals! If you apply solder to a passive oxidized surface, it will bead up into a ball and pull away--much like water on a freshly waxed automobile (Figure-A). This process is called *retraction*. Solder retracts because there are no bonding sites on the surface where it can take hold and hang on. Instead, a ball forms because internal cohesion attracts the solder molecules toward each other.

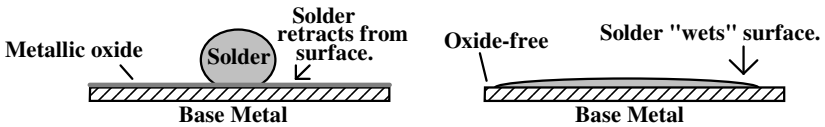

A. Cohesive forces pull solder into a ball. B. Adhesive forces spread solder out.

Flux is a specially-formulated chemical agent that *removes oxide* to expose the base metal underneath. Once oxide is removed, the surface becomes chemically "active" (Figure-B). This means the molecular bonding sites are restored and the surface is again free to combine with other metals. When liquidous solder is applied to an activated surface, powerful molecular forces take over--pulling the solder downward and forcing it outward to cover the area in a process called adhesion. When solder adheres to a chemically active surface, we say it *wets* the surface. Complete wetting is essential for good solder connections.

In addition to removing oxides, flux has a second job--to form a *protective coating* over the newly-activated metal. Although flux is a semi-solid at room temperature, it melts and spreads well below the melting temperature of solder. This allows it to flow ahead of liquidous solder--activating the surface and locking out air to prevent re-contamination.

Finally, it's important to remember that flux isn't a "cleaning agent". Flux removes oxides through chemical action and floats them off the surface in a chemical suspension. If metal is dirty, greasy, or contaminated in other ways, it should be cleaned prior to applying flux. Also, note that flux residue contains the oxides it has removed after the solder connection is made. In some applications, these deposits may need to be removed through cleaning.

### Common Types of Flux

Fluxes fall into two general categories--*inorganic* and *organic*. Inorganic, or "acid-core" types, are normally used for plumbing and are far too corrosive for electronic applications! Most electronic solder fluxes are organic. Organic flux falls into three classes: *rosin*, *water-soluble organic*, and *solvent soluble organic*. Of those groups, rosin flux is most common. Rosin is a natural substance produced by pine trees that contains *abietic* (a-bee-tic) *acid*. Rosin fluxes are classified by their degree of chemical activity and residue conductivity. Some rosins are mild and poorly-conductive, while others are very aggressive and more conductive. The two most-common rosin fluxes are RMA and RA:

**RMA Flux:** "Rosin--mildly activated" flux (RMA) is a good choice for assembling products made from highly solderable metals. The cleaning action of RMA is adequate for hand assembly in a well-controlled manufacturing environment, but generally insufficient for general bench and field work where

oxidation is more prevalent. The residue from RMA flux is relatively non-conductive and non-corrosive.

**RA Flux:** "Rosin--fully activated" flux (RA) is the most widely-used flux, and clearly the best choice for bench and field work. RA flux delivers more aggressive cleaning action, and it activates a wider range of solderable metals than RMA. Although RA residue is more conductive and corrosive than RMA, it is also "self-encapsulating". This characteristic isolates corrosive agents from air and moisture to prevent long-term contamination. On the down side, encapsulation may interfere with probe contact during testing procedures, and its protection may fail to hold up when exposed to extreme humidity and moisture.

Other rosin flux formulations are available, but rarely used for hand soldering. For example, "R" flux (non-activated rosin) is too mild for most practical applications, and "highly-activated RA" leaves a highly corrosive residue that must be removed immediately after use. In addition to the popular RMA and RA rosin fluxes, other formulations such as *water-soluble* and *no-clean* flux are now widely available in wire solders.

**No-Clean Flux:** "No-clean" flux contains few solids (2-5%), and leaves only a small trace of non-corrosive and non-conductive residue behind. This, in turn, eliminates the need for cleaning after the job is completed. No-clean flux is less aggressive than RA, which reduces its usefulness for general field and bench work where oxidation may be poorly controlled. However, "no-clean" works very well for hand-assembling new circuit boards, and is especially popular with technicians and engineers for surface-mount prototype work.

**Water-Soluble Flux:** This organic water-soluble flux consists of citric, glutamic, or lactic acids dissolved in a water or alcohol base. On the plus side, water-soluble flux is more aggressive than rosin fluxes, and it successfully activates some metals that RA flux cannot. On the negative side, water-soluble fluxes leave organic acids and salts behind which are potentially corrosive and conductive--and these must be removed immediately after use. Of course, removal is relatively easy, since only water and mild non-toxic cleaning agents are needed to do the job.

### **Supplemental Flux**

When hand soldering, flux is delivered primarily through the core of solder wire. In some cases, "core flux" may not provide sufficient chemical action to get the job done, and additional flux is needed to fully prepare the area. Supplemental fluxes are available from distributors in most popular types (RMA, RA, no-clean, etc.), and may be dispensed as a paste or liquid--depending upon packaging.

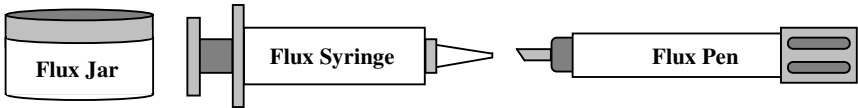

Flux Pastes are most often packaged in a small jars or a plastic syringes. Jar paste is applied to larger areas with a flux brush, and to miniature surfaces and with a wooden toothpick. Paste-filled syringes come with special applicator tips which offer controlled flow-rate and pin-point placement. Replacement tips are available in a variety of sizes. Syringes provide convenient packaging, and they work well for a wide range of tasks. The *flux pen* delivers flux as a liquid, much like a felt-tip marker delivers ink. Pens are especially convenient for miniature PC board and surface-mount work. Supplemental pastes and liquids may evaporate and dry out when exposed to air for long periods. Be sure to cap or cover all flux containers when not in use. Refrigerating during prolonged periods of non-use helps extend shelf life.

### PC Board Cleaners and Flux Removal Solvents

Most off-the-shelf cleaners are formulated for removing rosin-core flux residues (RMA and RA). Although cleaning is routine during automated PC board assembly, residue removal *may not be required* for general purpose bench and field hand-soldering jobs. That's because RMA and RA fluxes are self-encapsulating, and "no-clean" fluxes leave no harmful residue behind.

If cleaning *is* needed to satisfy a cosmetic or technical requirement, consider using an alternative to older-style CFC-based organic solvents. While CFCs are very effective, the price, toxicity, and environmental impact may not be justified. Less-toxic *organic solvents*, *alkaline saponifiers* (sap-on-a-fires), and *emulsion cleaners* are now available to do the job with minimal risk. Organic solvents dissolve rosin deposits, while saponifiers and emulsion cleaners convert them into water-washable substances.

Before using any flux removal product, read instructions carefully! Most organic solvents require adequate ventilation and other safety precautions for safe use. A stiff-bristle brush is usually needed to remove particles and debris (a discarded toothbrush works well for this). After handling cleaning chemicals, be sure to clean hands thoroughly before eating or smoking. Finally, *never improvise by using solvents not specified for flux removal*. These may expose you to a needless health hazard, and may also damage chemical-sensitive plastics on the PC board!

## Purchasing and Using Solder--A Quick Review

By now, you're probably getting the idea that "grabbing any old roll of solder" to do a job might not yield the best results! Before you select a product, ask yourself the following questions:

1. Is the solder *alloy* right for the job?
2. Is the *wire size* matched to the task (too small, too big)?
3. Is the *core type* acceptable (single, multi, or solid)?
4. Is the *core size* going to deliver the right amount of flux?
5. Is the *type of flux* right for the application?
6. Is *supplemental flux* needed?
7. Will the *flux residue* require removal?
8. If so, what type of *cleaning product* is best?

You probably won't always be able to find exactly what you want! However, if you understand solder specification and what they mean, substitution should be easy. For example, for most routine PC board hand-soldering jobs, a 60/40 alloy in a .031" or .040" wire size with a 3.3% (regular) RA flux core works well. From that starting point, you can add other solders to accommodate specific tasks. For example, a 63/37 alloy in a .020" wire size with 3.3% RA (or "no-clean") flux works well for surface-mount applications. And, a roll of "fat" 60/40 might come in handy for assembling high-power equipment with large components.

When forced to use "SE" (or someone else's) solder, always read the label first! If the flux is unaggressive or the core size "small", use supplemental flux (usually RA). If the flux is highly-activated RA or water-soluble, remove the residue afterward. Finally, if it's acid core or the roll's unmarked, put it back and find something else. It always pays to be an informed consumer!

## LESSON 3

### *Soldering--Health and Safety*

Industrial hygienists evaluate occupational safety in terms of *acute* and *chronic* health hazards. Acute hazards relate to immediate threats from traumatic injury. A misplaced cable that causes someone to trip and fall downstairs is an acute health hazard. Chronic hazards relate to long-term threats from toxic agents. A chemical known to cause cancer after prolonged exposure to its fumes is a chronic health hazard. Soldering isn't regarded as a high-risk activity in either category, but there are hazards you need to know about and avoid.

#### **Acute Hazards**

**Burns:** The most obvious short-term health hazard associated with solder is heat. Iron tips typically operate at 600-800 degrees F, and the temperature of molten solder exceeds 350 degrees F. Moreover, liquidous solder can spatter over a wide area without warning. Either of these heat sources can inflict painful burns and even permanent injury.

To reduce your vulnerability to heat-related injuries, always wear appropriate clothing and eye protection (no shorts or tanks tops if you value your skin). In the event of accidental skin contact with a hot iron or hot solder, immediately run cold water over the burn area. This first-aid response cools skin rapidly to limit tissue damage, and anesthetizes damaged nerve endings to reduce pain! Never apply butter or any other substance--only ice or a cool wet towel. If severe blistering or wounding breaks the skin barrier, seek further medical attention as soon as possible to prevent secondary infection. Also, have *any eye injury* resulting from a solder spatter checked at once--no matter how minor.

**Electric Shock:** Electrocution is a second acute hazard associated with soldering and solder irons. Most thermostatically-controlled solder stations supply low voltage to soldering tools, greatly reducing the risk of injury. However, solder-station control units, self-contained desoldering tools, and unregulated bench irons usually connect directly to the 110-volt AC line. Inspect plugs and power cords frequently for heat damage, iron burns, or wear. Also, confirm the integrity of power-plug grounds. Damaged power cords should always be replaced, and never repaired using electrical tape or shrink tubing! Finally, *never* attempt soldering operations on a piece of electronic equipment while it is connected to a power source!



## Chronic Hazards

**Lead Poisoning:** Lead is a toxic substance that accumulates in the body over time. If toxic levels are reached, the impact on health will be serious. Medical outcomes may include damage to productive organs, cancer, birth defects, colic, kidney disease, paralysis, brain damage, and even death! Fortunately, electronic soldering is done at temperatures well below the "fuming point" of lead, so lead vapors pose little threat to your health. Mishandling lead-bearing solder wire presents a greater long-term hazard. Each time you use solder wire, a small quantity of lead is transferred to your fingers. This, in turn, may be ingested when you handle food or smoke cigarettes. Although the amount of lead transferred may be small, it can accumulate to dangerous levels over time. To prevent unwanted lead from accumulating in your system, it's extremely important to wash your hands thoroughly after handling solder--especially before eating or smoking!

**Flux Fume Inhalation:** Solder fluxes may also present a chronic health hazard. Some flux vapors contain mineral acids that are irritating to the skin and toxic to inhale. Repeated exposure may produce asthma-like respiratory symptoms or chronic throat irritation. To minimize your exposure to flux vapors, ventilate the area around your soldering station. A small portable air-filter, or a larger ducted ventilation system, work well for removing airborne irritants. If ventilation is unavailable, avoid breathing in visible plumes of smoke or strong-smelling vapors. Even a small fan aimed across your work area will help to blow irritants clear and reduce exposure.

**Other Workplace Hazards:** In addition to solder, electronic work areas usually harbor a collection of flux solvents, degreasing chemicals, and PC board etching chemicals. Also, high-speed drilling and abrasive cleaning of PC boards generates airborne particles of epoxy and copper dust. Most of these substances present one or more health hazard, ranging from mild respiratory irritation to severe or deadly toxic effects. Be sure to obtain and read MSDS information (hazardous material data sheets) for *all* chemicals stored in your work area. Know how to use them properly, and know what to do in case of an accidental spill or over-exposure!

## LESSON 4

### Soldering Irons

**Types of Irons:** There are a lot of different soldering irons out there, and choosing the right one can be as confusing as choosing the right roll of solder! Electronic distributors offer products ranging from ten-dollar hobby irons to microprocessor-driven rework stations costing several thousand dollars. All soldering irons do pretty much the same thing--heat connections and melt solder alloys. But, there are differences in how they do the job--and *how well* they do it! Here's a survey of the popular hand-soldering irons in use today.

**Low-Cost Hobby Iron:** These are simple low-cost consumer products intended for home-owners and beginning-hobbyists. Most provide a two-wire power cord connected directly to a fixed-output 110-volt 30-40 Watt heating element. Iron tips are ungrounded and unsuited for working with static-sensitive components. Elements and tips aren't designed for continuous use, and replacement parts may be hard to find--making these products "throw-aways" when they fail (not suitable for lab or shop use).

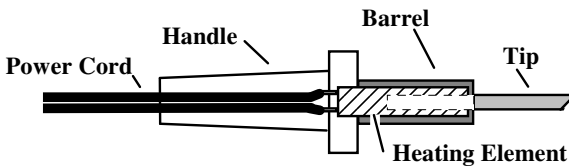

**Unregulated 110-volt Professional Iron:** These irons work on the same principle as low-cost hobby irons, but the heating elements and tips are higher quality and designed for continuous use. Power cords may be two-wire (isolated tip) or three wire (grounded tip). Tips and elements are easily replaced, and a variety of wattages and tip styles may be used with the same basic handle assembly. Some "high-end" 110-volt irons may have thermostatic temperature control, but most will not.

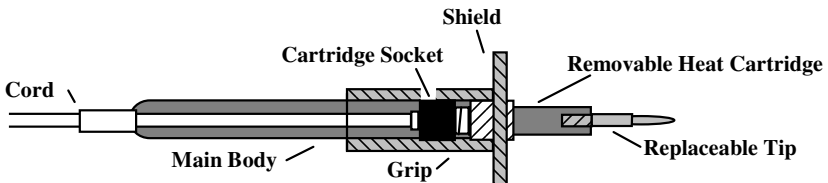

**Transformer Powered Soldering Station:** Transformer-powered soldering irons run on low voltage. Typically, a transformer unit enclosed in a separate bench-top control box converts 110-volts to 24 volts. Irons plug into a socket on the front panel of the box, allowing for rapid substitutions. Virtually all transformer-powered stations use three-wire AC cords and provide grounded iron tips. Grounded tips bleed off electro-static discharge (ESD) that might otherwise build up on the iron and damage sensitive electronic parts during construction.

Two kinds of temperature control are popular, depending on the solder station's model and manufacturer. One method uses magnetic-thermostat switching with a temperature-sensitive element built into the iron's tip. The type of tip you install controls temperature. The classic "Weller Soldering Station", an industry mainstay for over 30 years, uses the magnetic thermostat design.

Other soldering stations use an electronic thermostat that provides continuously adjustable temperature control. All thermostatically-controlled irons apply element power on demand to maintain a more constant tip temperature. This is an important feature not found on lower-cost unregulated irons.

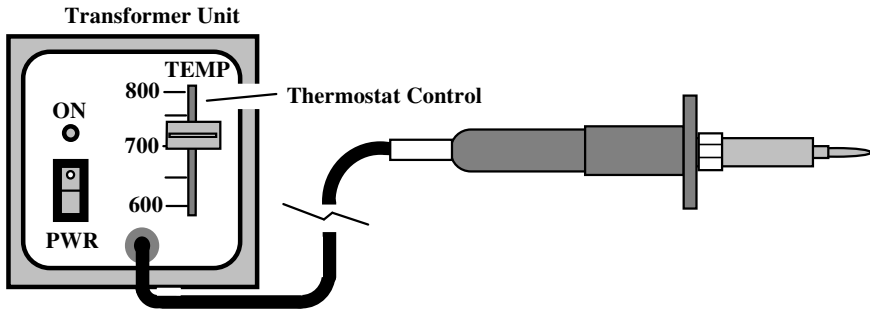

**Mini-Irons:** With the advent of surface-mount technology and increased miniaturization, a smaller version of the conventional soldering iron has gained popularity. Light-weight "mini-irons" (or soldering pencils) outfitted with ultra-fine tips reach into tight spots where other irons can't reach. Mini-irons are available in both unregulated and thermostatically-controlled models.



**Alternative Soldering Irons:** For field work or quick bench jobs, many people prefer to use a "no-plug-in, fast heat" alternative to the traditional iron. The most common energy sources for these irons include internal rechargeable NiCd batteries and liquid butane fuel. Portable types may not deliver the power and

temperature regulation of a transformer powered bench station, but they get small jobs done quickly without need for running extension cords or removing equipment from remote locations. Another type of alternative iron, the trigger-operated soldering gun, has been around for many years. These days, battery-powered versions are especially popular.

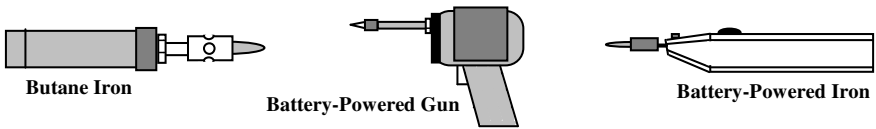

**High-Capacity Irons:** High-output irons are characterized by powerful heating elements (100 watts or more), elevated tip temperatures (up to 1000-degrees F), and massive tips. These "Big-Bertha" irons are especially useful for heating large surface areas, heavy-gauge wiring, and certain types of RF-cable coaxial connectors. Most shops and labs have one tucked away for special jobs. High-output irons can inflict severe burns very quickly, and must be handled with plenty of respect!

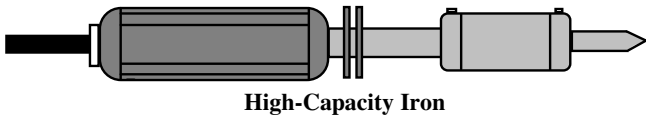

Other specialized resistance-soldering systems are sometimes used for connector installation—especially in manufacturing. Resistance soldering units consist of a powerful low-voltage high-current transformer connected to a special clamp-on hand-tool. When the hand-tool is clamped on, it literally turns the entire metallic part into a heating element! Heating is uniform and fast with these systems.

**How Soldering Irons Work:** A soldering iron has two jobs. First, it generates thermal energy (or heat) by means of a heating element. Second, it stores up and transfers that heat to a solder connection via the tip. Prior to contact with a solderable connection, the iron pre-heats well above the melting temperature of solder (typically 600-800-degrees F). As it heats, a substantial reservoir of thermal energy becomes stored in the barrel and tip. Upon contact, an energy exchange takes place that simultaneously heats up the solder joint and cools down the iron. Most of the heat required to complete an average connection comes from stored energy alone. However, the element assists by pumping new thermal energy into the tip to slow its rate of cooling. Once tip contact is broken, the element immediately begins to reheat the iron, restoring an energy reservoir in preparation for the next connection.

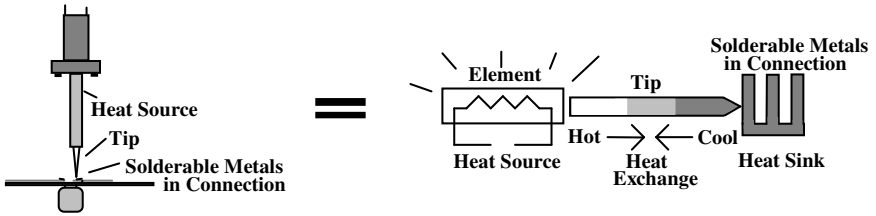

**Mass, Temperature, and Thermal Energy:** The amount of heat energy stored by your iron depends on several factors, but the two most important ones are *the tip's mass and the tip's temperature*.

**Mass:** As the iron's element pumps heat energy into the barrel and tip, the molecules move faster--causing the tip to get hotter. When the iron makes contact with a cold connection, heat energy is liberated and the molecules start to slow down. The greater the metallic mass, or the more molecules you have in your tip, the more thermal energy it will store *for every degree of temperature rise*. An iron with a big tip stores more thermal energy for every degree of temperature rise than a small one. That's because more molecules are available.

**Temperature:** The higher the tip's temperature rises, the more thermal energy you can store (per ounce, gram, or whatever). That's because it takes more energy to make a fixed number of molecules move faster. Conversely, the further the temperature drops, the more energy you can liberate. Faster-moving molecules have more energy to give off.

To put this in perspective, say you need to heat a connection to 400 degrees F so it will melt solder. It makes sense that a 800-degree F tip will contribute more thermal energy to the heating process than an *identical tip* heated to only 600-degrees F. However, a *more massive tip* heated to 600-degrees F could contribute the same amount of energy as the less massive 800-degree F tip--because more storage mass is available in the bigger tip.

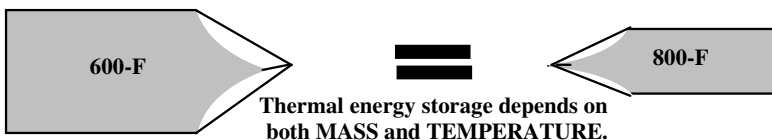

Without getting into BTUs (British Thermal Units) and the finer points of hermodynamics, we can generalize the concept and say:

1. A *more massive tip* contributes more energy to a solder connection than a smaller tip (per degree of temperature rise).
2. A *hotter tip* contributes more energy than a solder connection that a cooler tip (per unit volume of tip mass).
3. And, finally, a *larger and hotter tip* contributes a lot more energy than a smaller cooler tip.

Of course, practical considerations limit how massive or hot a "real world" soldering iron can get! Irons need to be relatively small and light-weight to work on today's miniaturized equipment. Also, any time tip temperatures rise above 750-800 F, excessive heat can easily destroy sensitive miniature components and damage solder pads on PC boards. It all comes down to finding the right balance.

**Selecting Unregulated Irons:** The heating element in an iron without thermostatic control remains powered continuously. Continuous heating means the iron cannot adjust itself to a very wide range of heat demands. If the iron is too small for a given job, the tip will cool too rapidly and won't transfer enough heat to melt solder. If too large, it may overheat sensitive components and damage PC boards. Ideally, the wattage of the heating element--along with the size and shape of the tip--will provide a good "fit" with the demands of the job at hand. The chart below provides guidance for selecting an unregulated iron:

<u>Element</u>	<u>Tip Temp.</u>	<u>Tip Dia.</u>	<u>Application</u>
25-W	625	1/8"	Precision, SMD
30-W	700	1/8"	Instrument repair
35-W	750	3/16"	Light PC board
50-W	800	1/4"	PC-board, small connectors
60-W	750	5/16"	Hand-wiring, installing connectors

In addition to choosing the right iron, it's important to choose the right tip. We've noted that tips with greater mass store more energy (that's why irons with more powerful heating elements come with larger tips installed). A small diameter tip with a thinly-tapered end has less mass available for storing energy--and less contact area to transfer heat onto the connection. This could be an advantage when soldering extremely fine or temperature-sensitive work, but an extreme disadvantage when soldering heavy parts onto large PC board land areas. For heavy jobs, a large-diameter tip with a blunt screwdriver shape stores and delivers energy more efficiently.

**Using Thermostatically-Regulated Irons:** Thermostatically-regulated irons and solder stations are more flexible because they can adapt to a wider range of heat demands than unregulated irons. While unregulated iron elements are

relatively small and run continuously, regulated element are larger and turn off as soon as the iron reaches a pre-set tip temperature. This limits the amount of thermal energy stored in the tip, preventing damage to sensitive components and circuit board pads. As tip contact is made with the cool surface of a connection, the thermostat senses a temperature drop and applies full power on the heating element. The larger element contributes significantly more thermal energy to the tip than would be available from a smaller unregulated element. As a result, the regulated iron can solder larger connections and recover more quickly than its unregulated counterpart.

By the same token, a regulated iron with a continuously-adjustable thermostat offers even more flexibility than one with a fixed-temperature thermostat. Adjustable thermostats may be used to establish the *quantity* of thermal energy stored in the tip. For extremely fine work, reducing the temperature control below normal settings reduces the amount of stored thermal energy, protecting small PC board pads and temperature-sensitive parts from damage. By the same token, increasing the temperature control above normal increases the amount of thermal energy stored for big jobs.

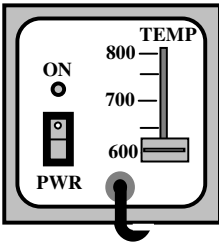

A. Temperatures 600-F and below are best for miniature work--less likely to damage small parts and delicate pc-board soldering pads.

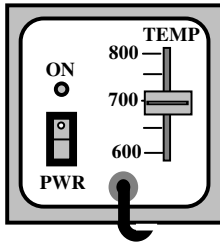

B. Temperatures around 700-F are best for general pc-board work--enough energy to solder quickly without damaging board.

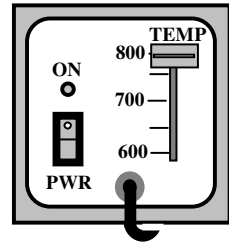

C. Highest temperatures are reserved for larger connections and large land areas on pc boards. Use caution to prevent damage.

In the end, unregulated and regulated irons are both capable of doing a good job. However, the size of the unregulated iron you select--or the way you adjust your soldering station's heat controls--can make a big difference in how well you perform as a craftsman!

Here are some signs that will help you recognize when it's time to make a change:

**Too Little Heat:** When your iron fails to deliver enough thermal energy, solder may melt slowly, incompletely, or not at all. If solder is melting at the point of iron contact, but not beyond, find a more powerful iron or crank up the thermostat! A properly heated solder connection flows outward--wetting the entire area.

**Too Much Heat:** When the iron is too hot, you may observe more smoke and an increase in flux spattering. You may also begin to see de-wetting because flux is burning off rather than coating and protecting the connection area. Worst of all, the iron may begin delaminating and lifting pads and traces off the PC board! If this happens, get a lower-power iron or turn down the heat fast--before irreversible damage destroys the board!

## LESSON 5

### *Soldering Iron Tips*

Manufacturers provide a wide range of tips to go with the irons they sell, and choosing the right tip can be as important as choosing the right iron! Here's a brief survey of the more popular tips in use today:

**Screwdriver Tip:** The screwdriver tip provides a wedge-shape that's especially handy for working on boards and terminals with flat areas. The extra width provided by the blade improves contact area and promotes rapid heat transfer. A long shank with a narrow blade stores and delivers less heat, favoring miniaturized applications. A short shank with a broad tip stores more heat and delivers it more rapidly for larger components or broad PC land areas. The one you choose depends on the kind of work you do.

**Chisel Tip:** This variation on the screwdriver is wedged on one side only--providing a large contact area and fast heat delivery to flat surfaces.

**Conical Tip:** Shaped like a cone, these tips concentrate heat toward one spot for "pin-point" soldering. Conical tips work especially well for platethrough type PC boards, where heat is focused on a small solderable eyelet imbedded in the PC board. Conical tips also work well for soldering miniature connectors and terminals. Long and skinny conical tips deliver thermal energy at a slower rate than short stocky conical tips. Short cones deliver thermal energy faster for heating large component leads, eyelets, and heavy terminal areas.

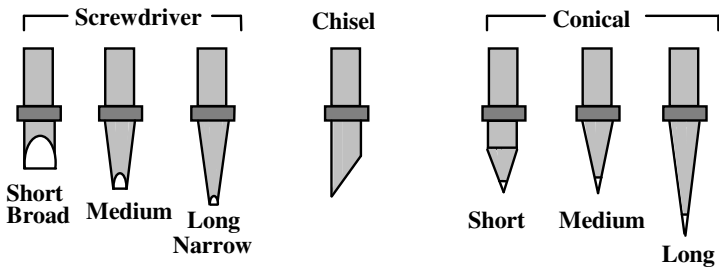



Some manufacturers offer special variations such as the "bent conical tip" or "micropoint tip" for special applications. Also, for slightly better heat transfer, some narrow screwdriver tips may be used interchangeably with the longer conical tips.

**Tip Construction:** Most iron tips are made from copper, a metal with unusually good thermal storage and heat transfer characteristics. Although great for storing heat, copper is quite soft and oxidizes rapidly when exposed to air. If used "as is", copper tips erode quickly and require continual maintenance. To prevent this, manufacturers electroplate them with one or more protective layers to add toughness and extend life.

One popular tip-plating scheme is illustrated in the following diagram. The outer layer of the shank is electroplated with chrome, a non-solderable metal. Chrome is applied to prevent solder from wetting and sticking to the back portion of the tip. This reduces the need for cleaning, and prevents the shank from becoming stuck in the iron barrel due to a buildup of solder deposits. A layer of nickel plating beneath the chrome outer-surface prevents corrosion and "pitting" as the tip ages. The inner-most layer of electroplate is iron, and this covers the entire tip. Iron helps harden the shank, and it prevents solder from combining directly with the softer copper core beneath the tip's contact area. Note that the contact area is tinned with solder. Maintaining this surface is an important part of tip maintenance and care. Without complete wetting of the contact area, heat transfer would be extremely difficult--and the iron would fail to perform!

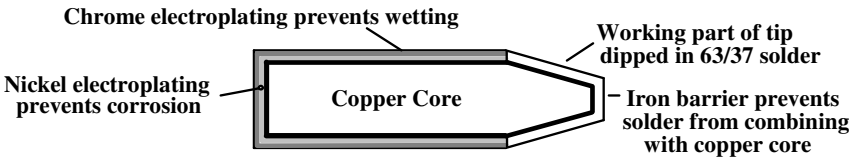

The exact composition and layering of a tip's outer shell may vary from manufacturer to manufacturer, but most high-quality tips have multiple layers of electroplating to ensure long life and top performance.

## LESSON 6

### *Tip and Iron Maintenance*

Soldering irons are subjected to the natural forces of oxidation, corrosion, and metal fatigue--but at a greatly accelerated rate due to high operating temperatures! To fight the forces of deterioration, irons require frequent inspections and maintenance. Inspections are needed because irons rarely "quit cold" when they get tired. Most often, performance will deteriorate slowly. Those "perfect connections" that used to seem routine will become progressively more difficult to make! When this happens, you *could* be experiencing a "bad bench day". However, it's far more likely your soldering iron and tip are overdue for some serious TLC!

**Caring for Tips:** If you keep your tips clean and well-tinned, they'll take good care of you. Here are some suggestions for getting the best performance:

- 1. Always use a cleaning sponge.** A thoroughly dampened cleaning sponge is the best way to clean your tip prior to making connections. Heat-resistant iron or pencil stands with built-in sponge trays are inexpensive--and they're a "must" for every bench! If the water in your area has a high mineral content, use distilled water--otherwise, water-borne minerals may bond with the iron electroplating in the tip and contaminate it. Also, don't neglect your NiCd or butane-powered irons--these tips should be clean, too!
- 2. Always clean your tip *before* making the connection--*never* after!** Tip cleanings remove old contaminated solder so it won't mix in with the "new stuff" you're about to apply. However, once a tip is sponge-cleaned, only a very thin layer of solder remains. If you don't reinforce this thin coating quickly--either by making a connection or by re-tinning the iron--it will oxidize and may cause your tip to de-wet! To prevent de-wetting, always leave your iron with a healthy protective coating of fresh solder between connections--and coat it especially well before shutting down. Never sponge-clean and shut down.
- 3. Some solders are tougher on tips than others.** When using small-diameter or low-flux solders, check the condition of your tip frequently. These solders often fail to deliver sufficient flux to maintain good tinning! To prevent de-wetting, apply supplemental flux and keep the tip well coated with solder between connections. Also, be aware that highly-activated rosin and organic water-soluble fluxes are more corrosive than less aggressive types, and regular use may mean more frequent tip replacements. This is a normal condition, so don't avoid using aggressive fluxes to save your tips! Just keep a closer eye on their condition.

4. **Never use the tip as a prying tool.** Screwdriver tips shouldn't be used to pry up flattened-over leads or to wedge apart solderable surfaces. This will damage the electroplated iron shell protecting the tip's contact surface and expose the copper core. Exposure, in turn, will cause rapid tip erosion. Also, avoid applying excessive iron pressure to PC boards to improve thermal contact. This, too, will damage electroplating--and it may delaminate the pad!
5. **High-temperatures are tough on tips.** When using tip temperatures above 650-700 degrees F, take time to clean and re-tin your iron more often. Oxidation occurs more rapidly at higher temperatures, increasing the possibility of de-wetting.
6. **Never file, sand, scrape, or grind a plated tip to clean it.** Once electroplating is compromised, core erosion will destroy the tip rapidly! If the tip is contaminated enough to require dressing, use a special polishing bar (available from many electronic supply houses). If the tip's outer plating is cracked or delaminated, don't waste time dressing it out. Replace it immediately.
7. **Renew dewetted tips.** If a tip de-wets and resists further tinning, you still may be able to save it. While the tip is hot, try a gentle cleaning with a soft wire brush or a very fine-grit emery paper (avoid aggressive abrasives that could break through the electroplate). Once the heavier oxides are removed, dip it in RA flux and attempt re-tinning. It may take several flux-cleaning and tinning cycles to restore full wetting. If this fails, replace the tip!

## Soldering Iron Cleaning and Maintenance

Like tips, irons get "crusty" and need maintenance. These steps will help you restore performance, improve safety, and extend life!

- 1. Remove heavy oxides and corrosion.** High temperatures cause the rapid buildup of scale and oxide deposits. These, in turn, decrease heat efficiency by increasing surface area. Use a soft wire brush to remove as much oxide as you can. However, avoid aggressive abrasives that could destroy metal plating.
- 2. Tighten screws and fittings.** Constant heating and cooling causes metallic parts to expand and contract. Over time, hardware loosens, decreasing contact and lowering thermal efficiency. Gently tighten loose screws and fittings, being careful not to over-torque (tap holes may strip easily after prolonged exposure to heat and corrosion).
- 3. Wipe down sponge trays.** Lead is toxic, and sponge trays tend to collect a lot of it over time! Remove the iron sponge and wipe down the tray area thoroughly. Dispose of lead debris carefully, and replace the cleaning sponge with a new one. Wash your hands after handling lead-contaminated materials.
- 4. Inspect cords and electrical connections.** Hot soldering irons and PVC electrical cords don't always mix! Inspect cords closely for heat fatigue, cracking, tip burns, and other signs of damage. Also, clean low-voltage plugs on solder stations. If these get corroded, the iron may lose thermal output. On irons with grounded-tips, connect a DVM between the AC plug's ground lug and the tip to check continuity. Never attempt to repair cords with tape or shrink tubing. Buy new ones! Burn-proof replacement cords are now available for many irons.
- 5. If a component is going bad, replace it.** Over time, heat and corrosion eventually win out, and iron parts need replacement! Order new parts at the first indication of trouble--before the iron's impaired performance deteriorates the quality of your work. Many items such as thermostat sensors, barrel assemblies, elements, and cords are available from electronic distributors or directly from manufacturers. Also, keep in mind that irons don't live forever. If yours needs a lot of new parts and its overall condition is deteriorating, it may be time to purchase a new one!

So far, we've covered a lot of material about solders, irons, tips, and supplies--but we haven't said too much about the hands-on art of *soldering*. The remainder of the course is devoted to that topic!

## LESSON 7

### *Soldering Applications*

Most hand soldering involves constructing circuit boards and wiring them into larger pieces of equipment. In this section, we'll cover the basic techniques used for constructing boards. We'll also cover the soldering methods used for installing jacks, switches, and connectors.

#### **Circuit Board Evolution and Circuit Board Types**

Circuit board technology has changed a lot over the years. Here's a "thumb-nail" look at their evolution--along with a rundown of the kinds of boards you're likely to encounter:

**Single-Sided PC Boards:** When printed circuit boards first came on the scene, all wiring was etched onto a copper-coated side, and all components were mounted on the opposite non-metalized side. The copper side was called the *solder-side* because all solder connections were made on that surface. The opposite side was called the *component-side*. The board itself was called a *single-sided* PC board because only surface was metalized.

**Double-Sided PC Boards:** Over time, as miniaturization increased and RF (radio frequency) construction techniques improved, designers began using copper on both sides of the board for wire-traces and grounds. These became known as a *two-sided* or *double-sided* boards. Although wiring was etched on both sides, construction methods usually dictated that components be mounted on one side only. Thus, the "component-side" and "solder-side" terminology stuck--and is still used today. When traces needed to be "through-connected" from one side to the other, this was done by soldering component leads on both sides of the board, and also by installing short wires through the board called *vias*.

**Plate-Through PC Board:** Eventually, techniques evolved for metal-plating the inside surfaces of the holes drilled in the boards. These metallized holes were called *plate-throughs*. Plate-throughs made electrical contact between pads on each side of the board. This innovation eliminated the need for soldering components on both sides and also eliminated the need for installing vias by hand. That, in turn, made automated soldering of two-sided boards both cost-effective and practical. A PC board with two etched surfaces and plate-through holes is called a *double-sided plate-through* board.

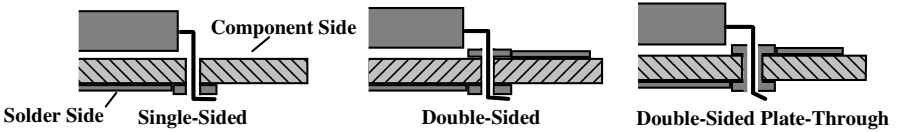

**Multi-Layer Boards:** With the advent of miniaturized computers and massive LSICs (large-scale integrated circuits), PC boards have now taken another step forward. Some PC boards contain multiple layers of conductive traces laminated into the board which are interconnected by plate-throughs. These are called *multi-layer plate-through* boards.

**Through-Hole and SMD Layouts:** Increasingly, sub-miniature leadless components are secured directly to the board's surface--reducing the need for drilled mounting holes. Because of this, we now distinguish between *through-hole construction*, where leads or mounting tabs penetrate the board, and *SMD or surface-mount construction*, where parts are held in place with adhesives and secured to pads with solder. This course focuses on through-hole construction, but many circuit boards now combine a hybrid mixture of both. Often, through-hole components are mounted on the top surface and SMD components mounted on the bottom. In other cases, they are mixed together.

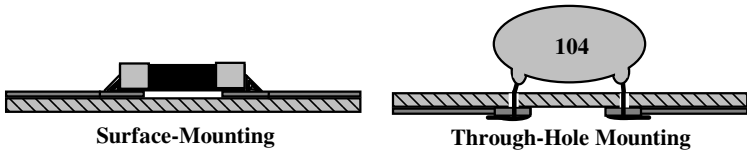

Single-sided, double-sided, and multi-layered PC board construction are all currently popular--depending on the application. Unplated and plated holes are also widely used. However, there are important differences between plate-through and non-plate-through hand-soldering techniques. In the next section, we'll look at the soldering methods for each.

**Circuit Board Soldering Techniques**

**Soldering Single-Sided Boards:** Single-sided boards remain popular for lab projects and low-cost electronic products because they are simpler and cheaper to make (many hobbyists and circuit designers make their own). When constructed properly, single-sided boards are extremely reliable and resistant to environmental deterioration.

**Cleaning and Preparing:** Etched surfaces on commercially-manufactured boards are usually pre-tinned to reduce oxidation. However, surfaces on

experimental or home-made boards may be untreated copper. Clean copper is a highly solderable metal, but it oxidizes and corrodes rapidly when exposed to air--losing solderability. As a result, *raw copper surfaces must always be cleaned thoroughly immediately prior to construction*. Steel wool, bronze wool, and chlorinated abrasive household cleaners work well for stripping away corrosion and heavy oxides. After cleaning, surfaces should appear bright, shiny, and free of oxide spots and streaks. If untinned boards will be constructed over a period of time after cleaning, store them in a dry air-tight container to minimize recontamination.

If surfaces are pre-tinned, don't scrub them with abrasives. This will remove rather than clean the protective coating! A quick washing with soap and water--or degreasing in a mild solvent--should do the trick.

**Component Installation:** Single-sided circuit boards normally provide somewhat larger pads than plate-through boards because the pad surface is the primary retention area for the solder connection. When installing components in unplated holes, the lead should be bent over and pressed firmly against the pad surface. The greater the contact area between lead and pad, the more mechanically and electrically secure the connection. Note that--whenever possible--leads should be bent in the same direction as incoming tracks to prevent inadvertent contact with adjacent pads or tracks (see below).



**Applying Heat:** Place the iron tip so it contacts both the component lead and pad. The objective is to heat *both* metal surfaces simultaneously. After about 1 second, apply solder to the *opposite side* of the wire from the iron tip (see below). The solder should melt due to contact with the solderable surfaces, and not from contact with the iron itself. Never melt solder on a connection by touching it to the iron tip!

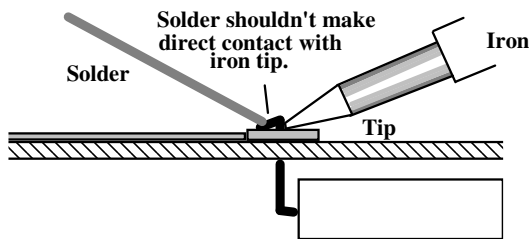

Solder should melt, flow, and wet the surface of the lead and pad to form a bright smooth connection. Rocking the iron slightly as solder flows will promote better solder distribution around the connection.

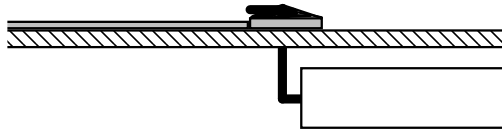

**Double-Sided Board, No Plate-Throughs:** Most commercially manufactured double-sided PC boards now have plate-through holes. However, hobby or prototype boards may not! On two-sided boards, the major grounded-plane surface is usually on the component side (top), and most of the interconnecting tracks are on the solder side (bottom). To ensure good RF (radio frequency) grounding, it's important to keep all ground connections on top as short as possible (see below). If ceramic disc capacitors are used, carefully remove any "flash" around the grounded lead prior to installation to expose a solderable surface. Make sure all vias are installed and soldered on both ends.

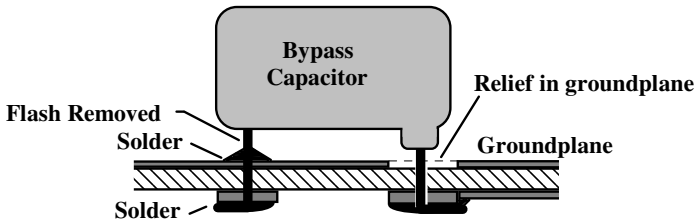

**Double-Sided (or Multilayered) Plate-Through Boards:** The solder technique for plate-through boards is different because the wall of the plate-through hole (or eyelet) provides the contact surface for the component lead. When installing parts in plate-throughs, it isn't necessary to bent leads tight against the pad surface. Only bend enough to ensure the component remains secured in place during soldering.

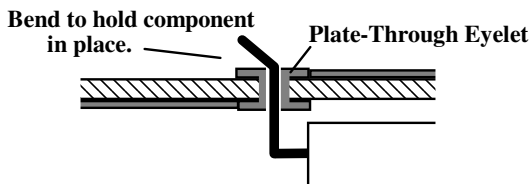



The objective is to solder the lead to the *inside of the hole*. Heat the lead and plate-through eyelet for about 1 second. Then, apply solder to the surface--allowing it to melt and wick down around the lead. Avoid loading up the pad with solder--the important thing is to fill the gap around the lead. Nip off any excess lead when the connection is complete.

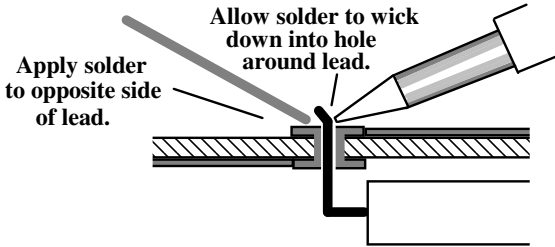

Use a similar soldering technique when installing components in multilayer boards. Note that plate-through vias *do not require soldering* because electrical contact is already established between layers by the plate-through itself.

### Hand Wiring Techniques

Before the days of PC boards, virtually all electronic interconnections were made using wire. Today, designers try to include everything--jacks, switches, connectors, and indicator lamps--on the printed circuit board. The reasoning is simple! It's a lot cheaper and faster to install "user-interface" components on a PC board with automated soldering than it is to hand-wire these parts onto a control panel using wire! Despite this, we haven't entirely escaped the need for hand wiring. When interconnections are made using wire, it's called *point-to-point wiring*. Point-to-point wiring is still widely used to interconnect circuit boards, power and signal leads, and electromechanical devices that can't be included on PC boards.

**Cable Terminations:** Interconnecting cables take two forms. Some may be soldered directly to pads provided on the circuit board. Others may be soldered to connectors that plug into the circuit board. Either way, interconnecting cables must be prepared carefully because they'll be subject to flexing and movement. Stranded wire is commonly used because it is more flexible than solid wire and it's less likely to break. Harnessing wires together with plastic ties helps to immobilize them, reducing stress. Good soldering technique reduces the chances of breakage or short-circuiting on the circuit board (see following diagram).

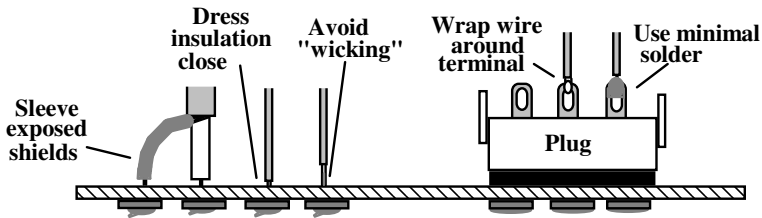

To prevent exposing un-insulated wire, install sleeving on ground shields. Also, dress wire insulation close to the board surface. When installing wires, avoid applying excess heat and solder--this causes hot solder to wick up wire strands, melt the insulation, and destroy wire flexibility (a major cause of breakage). The same rules apply to plugs. Dress insulation close to terminal tabs, and use minimal heat to prevent wicking. Follow the plug manufacturer's assembly instructions for capping plugs and immobilizing wires.

Larger control-system harnesses may use crimp-lugs to interconnect wires on terminal blocks. If these wires carry high-frequency signals, or if the terminals are exposed to harsh environmental conditions, crimping *and* soldering may be specified. When installing the lugs, crimp the wire (or wires) in place first--then apply heat, allowing solder to wick back into crimp area. Avoid depositing solder on the screw-down portion of the lug. This will make tightening to the block impossible later on!

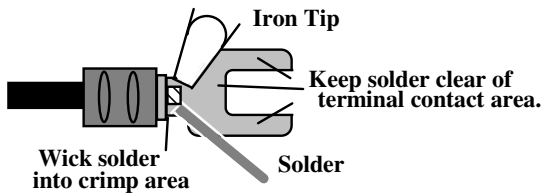

**Chassis Connectors:** When soldering wires to chassis connectors, observe the same precautions you would for PC board installation. If the connector terminal allows the wire end to pass through an opening, wrap it tight for a good mechanical connection before applying solder. If the wire end inserts into a hollow connector terminal, tin it prior to insertion for easier installation and better solder coverage.

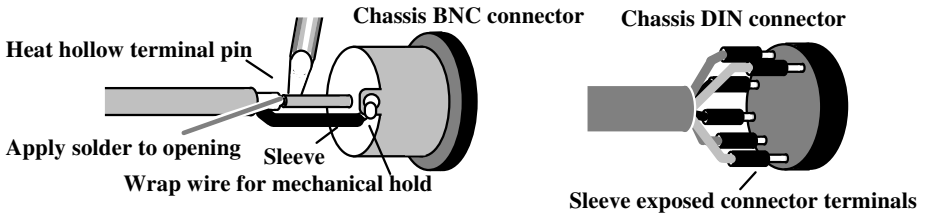

Make sure all wire strands are dressed cleanly. A stray strand hanging off a connector lug or terminal could cause a short circuit later on.

### Soldering--Good and Bad

If a connection is bad there will be tell-tale signs. By the same token, if a connection is technically "perfect", there will be tell-tale signs of that, too! Here are some visual clues for recognizing each:

**Solderability vs Retraction:** Solder adheres when surface areas are activated and bonding sites are available. If preparation is "good", the entire solderable area is available for bonding, allowing solder to flow outward and adhere uniformly. If preparation is "bad", surfaces resist bonding and the connection shows evidence of retraction. Here, solder may appear to "roll down" to a visible margin on metal surfaces, and "potholes" may be present where solder failed to adhere.

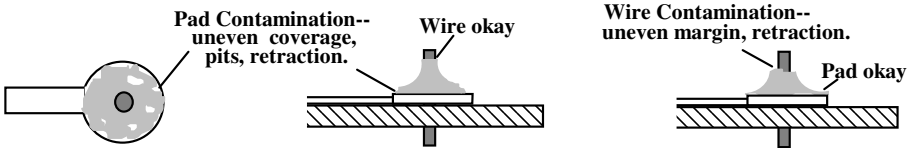

The cure for retraction is usually better PC board cleaning or lead preparation. If component lead contamination is a problem, heavy oxides can be removed easily by scraping with a hobby knife or swiping with emery cloth. A pencil eraser will clean pads without removing tinning.

### How Much Solder is Enough

In a good connection, solder appears bright, shiny, and uniformly distributed. Also, the surface of the connection may appear slightly concave due to strong forces of adhesion pulling solder outward during wetting. Avoid using excess solder. If the connection looks like a "solder mound" instead of a "solder volcano", you've applied too much!

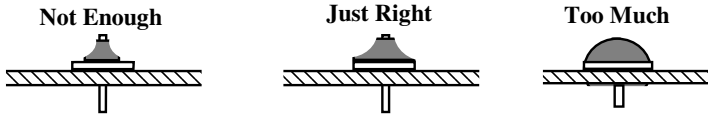

**Common PC Board Problems:** The three most frequent problems occurring with soldered connections are:

Cold Solder Joints: The "cold solder joint" is a catch-all term for connections that fail to make a reliable electrical contact. This could be due to one of the following:

1. A "grainy" or fractured joint formed because it was disturbed during the plastic phase of cooling.
2. One solderable surface on the connection was heated insufficiently, and bonding failed.
3. Retraction due to oxidation caused the joint to fail due to insufficient contact area.

Cold solder joints can often be repaired by re-heating and re-activating the joint surfaces with the introduction of more flux and some fresh solder.

Solder Bridges: These short circuits are usually the result of "gapping" between two adjacent pads or tracks (60/40 solder is more likely to gap than 63/37). Usually, removing some of the solder with wick or a solder vac will eliminate the problem.

Lifted Pads: A pad lifts when its bonding to the PC board fails due to excessive heat. A lifted pad, by itself, may not cause an immediate malfunction. However, sooner or later, a track break usually occurs at the junction of the lifted pad and the still-secured pc track. The fastest repair technique is to install a new part, and then solder the unclipped lead to a point further down the incoming track.

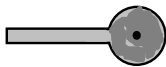

**Cold-Solder Joint**

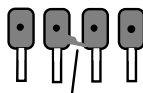

**Solder Bridge**

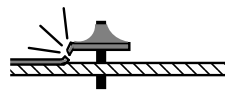

**Lifted Pad**

Looking for trouble (or excellence) in a solder connection is a little like going on an archeological expedition! The story is virtually always there, recorded for the ages in the solder itself. All you need do is look closely and read the signs!

## LESSON 8

### *Component Handling and Preparation*

We've looked closely at what happens on the bottom side of the board. This section takes a look at what happens on top. In order to follow diagrams and build working circuits, you'll need to recognize common components and read their value codes.

#### **Resistors**

Resistors limit current flow and provide voltage drop in electrical circuits. For low power circuitry, 1/4 or 1/8-watt molded resistors are most common. The resistive value of these devices is displayed by means of a banded color code.

#### **Resistor Color Code**

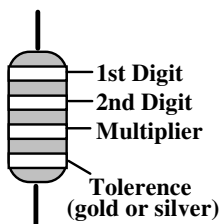

<b>Black</b> = 0 (tens)	<b>Blue</b> = 6
<b>Brown</b> = 1 (hundreds)	<b>Violet</b> = 7
<b>Red</b> = 2 (K)	<b>Gray</b> = 8
<b>Orange</b> = 3 (10K)	<b>White</b> = 9
<b>Yellow</b> = 4 (100K)	<b>Silver</b> = 10%
<b>Green</b> = 5 (1Meg)	<b>Gold</b> = 5%

When you look at a resistor, check its multiplier code first. Any resistor with a black multiplier band falls between 10 and 99 ohms in value. Brown designates a value between 100 and 999 ohms. Red indicates a value from 1000 to 9999 ohms, which is also expressed as 1.0K to 9.9K. An orange multiplier band designates 10K to 99K, etc.

#### **Capacitors**

Capacitors store electric energy, block the flow of DC current, and permit the flow of AC current. Unlike modern-day resistors, capacitors no longer use a color code for value identification. Instead, the value, or a 3-number code, is printed on the body.

Value	Code
10 pF	= 100
100 pF	= 101
1000 pF	= 102
.001 uF	= 102*
.01 uF	= 103
.1 uF	= 104

**Multilayer**  
(270 pF)



**Ceramic Discs**  
(.001 uF)    (.1 uF)



**Electrolytic**  
1 uF

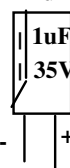

Multilayer caps are similar to a surface-mount "chip" capacitors, except that leads are spot-welded onto each end of the capacitor body. Multilayers have superior operating characteristics, but the lead welds *may* fail if the device is over-stressed. For this reason, *never use force to seat a multilayer cap* into the PC board. If the spacing isn't right, pre-form the leads to the correct spacing before installation!



For ceramic disc and multilayer capacitors, the transition from pF (pico-Farads) to uF (micro-Farads) occurs at 1000 pF (or .001 uF)\*. The first two digits indicate a numerical value, while the last digit indicates a multiplier (same as resistors).

Electrolytic capacitors are always marked in uF. Electrolytic are polarized devices and must be oriented correctly during installation. If you become confused by markings on the case, remember the uncut negative lead is always slightly shorter than the positive lead.

### Chokes and Inductors

Chokes block the flow of AC current while permitting the passage of DC. Molded chokes commonly used today are color-coded in much the same way as resistors (see below). While some chokes are specified in nano-Henries (nH) or milli-Henries (mH), most used in communications work are specified in micro-Henries (uH). The choke's third color band specifies its range. For example, a red, red, silver choke is .22 uH, a red, red, gold choke is 2.2 uH, a red, red, black code is 22 uH, and red, red, brown means 220 uH. The fourth color band indicates tolerance 10% for silver and 5% for gold.

### Molded Choke Color Code

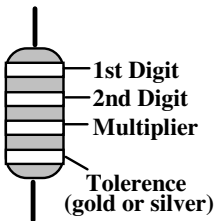

Black = 0 (tens uH)	Blue = 6
Brown = 1 (hundreds uH)	Violet = 7
Red = 2 (mH)	Gray = 8
Orange = 3	White = 9
Yellow = 4	Silver = .10 uH or 10%
Green = 5	Gold = 1.0 uH or 5%

Air-wound coils, toroids, and RF inductors belong to the same family of components, but offer no standard method of color-coding or identification. Check building instructions or part numbers for more specific identification.



**Air-Wound Coil**

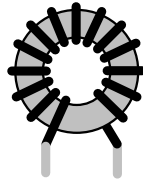

**Toroid Coil**



**Slug-Tuned RF Coil**

## Diodes

Diodes allow current to flow in one direction, but not in the other. Like electrolytic capacitors, diodes are polarized devices that must be installed correctly. Always look for the banded--or cathode--end when installing, and follow instructions carefully.

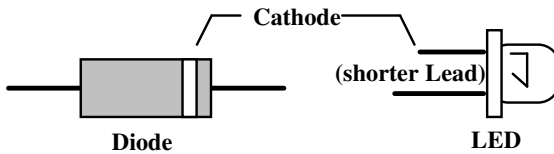

**Diode**

**LED**

## Transistors

Transistors are solid-state devices capable of amplifying or switching. If transistors are installed incorrectly, damage may result when power is applied. Transistors in metal cases have a small tab near the emitter lead to identify correct positioning. Semiconductors housed in small plastic cases (TO-92) have an easily-identified flat side to identify mounting orientation. Many specialized diodes and low-current voltage regulators also use this type packaging. Larger plastic transistors and voltage regulators use a case backed with a prominent metal tab to dissipate heat (T-220). Here, orientation is indicated by the positioning of the cooling tab.

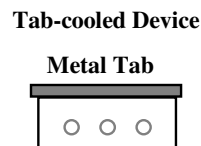
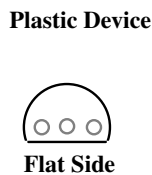
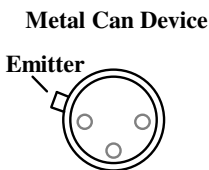

Before soldering a transistor in place, be sure to check specific installation instructions or consult a technical data sheets for that device.

### Integrated Circuits

Integrated circuits, or ICs, contain many active and passive devices (transistors, diodes, capacitors, resistors, etc.) which are connected together to perform a specialized task. These devices have a minimum of eight leads. Proper IC positioning is indicated by a dot or square marking located on one end of the device. A corresponding mark will be silk-screened on the PC board and printed on the kit's parts-placement diagram. To identify specific IC pin numbers for testing purposes, see the diagram below. Pin numbers always start at the keyed end of the case and progress counter-clock around the device, as shown:

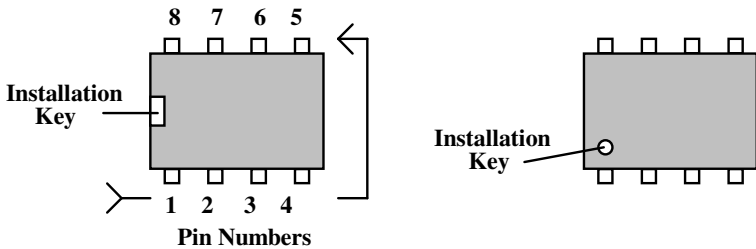



## LESSON 9

### *Desoldering for Repair or Replacement*

In addition to installing parts, it's helpful to know how to get them out! If you work carefully and use the right techniques, parts may be substituted or replaced with little or no damage to PC boards. Here are some common methods for removing them:

**Heat and Pull:** This old standby method involves heating a connection on the solder side of the board, and tugging the component free on the opposite side. Because components are removed in "see-saw" fashion, this technique is usually limited to parts with two leads. There's a fairly high risk of component damage from lead stress, so use care when extracting parts you intend to recycle.

**Heat and Brush:** The "heat and brush" method is another older technique that works best on single-sided boards where the pad surface is used for lead retention. First, the connection is heated--then molten solder is swept off the pad using a small stainless-steel wire brush. After sweeping, the bent-over component lead can usually be pried up with a hobby knife and removed. "Heat and brush" can get messy, since molten solder may fly onto nearby tracks and pads. Always inspect the surrounding area for solder bridges and debris! Other more contemporary methods may work better.

**Solder Wick:** Solder wick is a very handy soldering aid made from fine-mesh copper braid. It is highly-solderable, and will tend to "draw up" molten solder when applied to a heated connection. Wick is available in various widths from electronic distributors, and some types are pre-fluxed to enhance performance. To use wick, place it on the soldered surface and press down gently with a hot iron. As solder melts beneath, it will flow into the copper mesh--up and away from the contact surface on the pad. Wick is effective on flat surfaces and plate-through eyelets alike! If a plate-through lacks sufficient surface solder to start the wicking process, add a little more to the connection to "prime the pump". After each application, nip off the solder-saturated end of the wick and start over. Wick is a preferred method for desoldering both through-hole and SMD boards.

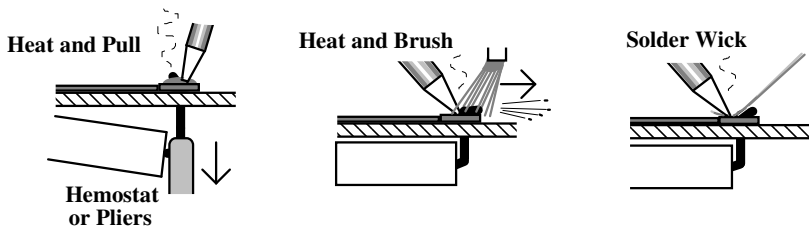

**Vacuum Solder Suckers:** This popular method of solder removal involves heating a connection, and then using vacuum to suck the molten solder up into a container. Solder suckers come in many different types, and cost anywhere from a few dollars to several thousand. The simplest types are rubber squeeze balls with heat-resistant nozzles and spring-loaded hand pumps with trigger releases. Both types are inexpensive, work marginally well, and rely on heat from a conventional iron to melt solder.

**Squeeze-Bulb Sucker**

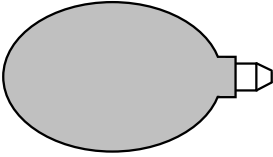

**Spring-Loaded Vacuum Pump**



Professional "rework stations" represent a giant step forward in terms of sophistication and performance. A few solder-gun-style hand-held units are available, but most are larger bench-top machines intended for high-volume repair and manufacturing applications. Some develop suction using built-in electric vacuum pumps, while others rely on compressed air lines to drive pneumatic pumps.

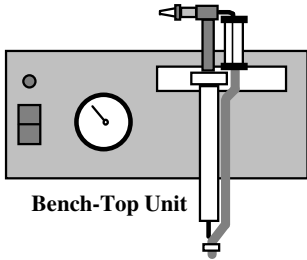

**Bench-Top Unit**

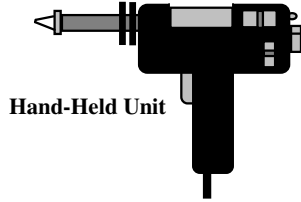

**Hand-Held Unit**

All suckers, from the simple to the complex, require frequent cleaning and maintenance to prevent clogging and ensure acceptable vacuum levels. Most work well on all types of boards, although you usually get what you pay for in terms of overall performance and usefulness. When used properly, suckers may represent the fastest and least invasive way to remove sensitive components.

**Other Tools of the Trade**

Removing components from boards and clearing solder from plate-through holes sometimes requires more than a desoldering tool alone can deliver. Stubborn leads may break off or get stuck, solder spatters have a way of wedging themselves into tight areas, and solder may not come out of plated holes with any

of the normal solder-removal methods. Many of these bench nightmares can be resolved with the help of a few simple tools.

**Electronic Shears:** Electronic shears, or "nippy cutters", are sharp close-cutting pliers that have virtually replaced traditional diagonal pliers for snipping off lead-ends. A good pair of these can slip under partially soldered-down leads and lift them off a soldered surface without damaging the pad.

**Hemostats:** Originally an emergency room medical tool, these small clamping devices are probably the best "third hand" you'll ever own for handling miniature components. They've become so popular in the electronics industry, companies now market them exclusively for printed circuit board work.

**Dental Tools:** Here's another medical tool that's found its way onto nearly everyone's electronics bench. The two most useful types are the "dental explorer", a small curved semi-flexible pick used for checking out cavities--and the "dental scaler", a sharp and tough little tool used for removing dental scale. Most electronic supply houses now have "dental tool" assortments sold exclusively for electronics work.

**Small Hobby Drill:** A small electric hobby drill is especially useful for removing left-over solder from plate-through holes. It will also drive a small burr to remove solder bridges, cut through tracks, or strip off tough insulating laminates from PC boards. Most hobby shops and larger electronic distributors carry an assortment of drill bodies, chucks, miniature bits, and rechargeable batteries. Be sure to order one with an adjustable chuck rather than a fixed-size collet. When cleaning out plate-throughs, *the bit you select must be smaller than the hole size*, or the plate-through wall will be destroyed.

**Hobby Knife:** The classic *Exacto*<sup>TM</sup> *Knife* outfitted with a #11 straight blade rounds out the list of "most popular bench tools" for PC board and hand-wiring. For cutting, scraping, de-burring, stripping, and scratching--this tool is hard to beat.

Speaking of tools, this concludes the "book learning" portion of the Vectronics soldering course. Now, it's time to step up to the plate and do some hands-on soldering using the Lab portion of the course. Remember to *look closely* at the connections you make. More than anything else, the solder will tell you how well you're doing!

# VECTRONICS SOLDERING COURSE QUIZZES

These quizzes are designed to reinforce the material you've read in each lesson. Use them as a study aid. If you have difficulty answering two or more quiz questions, we recommend returning to the lesson for a second pass.

## *Lesson 1 Solder Alloys and Wire*

1. Solder provides a (*strong/flexible*) \_\_\_\_\_ mechanical joint and a (low/high) \_\_\_\_\_ resistance electrical path.
2. The three "states" of solder are \_\_\_\_\_, \_\_\_\_\_, and \_\_\_\_\_.
3. Which solder alloy is more able to "wet" metals and bridge short gaps? (A.) 60/40, (B.) 40/60, (C.) 63/37, (D.) 2% silver. [ ]
4. Which solder alloy is most recommended for miniature electronics? (A.) 60/40, (B.) 40/60, (C.) 63/37, (D.) 2% silver. [ ]
5. Solder with a narrow plastic temperature range is called \_\_\_\_\_ solder.
6. Which solder has the narrower plastic temperature range? (A.) 60/40, (B.) 40/60, (C.) 63/37, (D.) 2% silver. [ ]
7. Which type of solder is least toxic? (A.) Low-temp, (B.) 2% silver, (C.) Lead-free, (D.) 60/40. [ ]
8. When selecting a solder wire gauge, manufacturers recommend using the (*largest/smallest*) \_\_\_\_\_ wire size with the (*highest/lowest*) \_\_\_\_\_ flux percentage practical to ensure good iron tinning and adequate flux delivery.
9. For general bench work, which wire-size is a good choice? (A.) .015", (B.) .031", (C.) .093", (D.) .125". [ ]
10. Which solder core will deliver the most amount of flux? (A.) 3.3%, (B.) No. 56, (C.) small, (D.) No. 50. [ ]

## ***Lesson 2 Kinds of Flux***

1. Flux prepares solderable metals by removing \_\_\_\_\_ from the surface.
2. When a solderable surface is prepared with flux, it becomes chemically (*active/passive*)\_\_\_\_\_.
3. When solder pulls away from a surface, it (*adheres/retracts*) \_\_\_\_\_.
4. When solder "wets" a surface, the process is called (A.) retraction, (B.) adhesion, (C.) cleaning, (D.) cohesion. [ ]
5. This highly popular flux contains abietic acid, is aggressive, and leaves a self-encapsulating residue behind. (A.) RMA, (B.) No-clean, (C.) RA, (D.) Water-soluble. [ ]
6. This aggressive organic flux may contain citric, glutamic, or lactic acid. Its residue is corrosive and should be removed immediately after soldering. (A.) RMA, (B.) No-clean, (C.) RA, (D.) Water-soluble. [ ]
7. This moderately aggressive flux contains 2-5% solids, and is especially useful for hand-soldering "new construction" where parts and circuit boards are clean. (A.) RMA, (B.) No-clean, (C.) RA, (D.) Water-soluble. [ ]
8. This organic flux works well for assembly of new products under controlled conditions, but may not be aggressive enough for general bench work and repairs. (A.) RMA, (B.) No-clean, (C.) RA, (D.) Water-soluble. [ ]
9. Older-style CFC organic solvents may not make be the best choice for removing flux residue because they are too (A.) expensive, (B.) toxic, (C.) harmful to the environment, (D.) all of the above. [ ]
10. (*T/F*) If you don't have an approved flux remover handy, it's okay to use Acetone in a pinch. [ ]

### ***Lesson 3 Soldering Health and Safety***

1. A bucket of bricks falling from a 10-story roof is an/a (*acute/chronic*) \_\_\_\_\_ workplace hazard.
2. Cancer-causing fumes leaking from a chemical tank is an/a (*acute/chronic*) \_\_\_\_\_ workplace hazard.
3. Accidental skin contact with a hot iron is the most common type of (*acute/chronic*) \_\_\_\_\_ injury associated with soldering.
4. The best first-aid treatment for a burn to the skin is to apply (A.) cold water, (B.) ointment, (C.) heavy bandage, (D.) hydrogen peroxide. [ ]
5. Obtain follow-up medical attention for burns that blister or break the skin to prevent the formation of a bacterial \_\_\_\_\_ .
6. A second type of acute injury, called \_\_\_\_\_, might be caused by a faulty electrical cord on a soldering iron.
7. Exposure to small amounts of lead from handling solder wire over a long period of time represents a/an (*chronic/acute*) \_\_\_\_\_ health hazard.
8. When soldering, the best way to avoid ingesting lead is to \_\_\_\_\_ your \_\_\_\_\_ prior to eating or smoking.
9. Flux fumes may cause asthma-like symptoms and chronic throat irritation. To reduce exposure, (A.) install a ventilation system, (B.) install a portable air cleaner, (C.) blow air from a small fan across the work area, (D.) any of the above. [ ]
10. The EPA requires that every chemical in your work area should be accompanied by a data sheet called a \_\_\_\_\_ (*four letters*). This presents important information you need to know concerning potential hazards, first aid, and emergency spill response.

## Lesson 4 Soldering Irons

1. Some soldering irons have "grounded tips" and some do not. The purpose of grounding is to prevent (A.) electrocution, (B.) fire, (C.) ESD, (D.) cold solder joints. [ ]
2. A soldering iron with a heating element that runs "full time" is called a (*regulated/unregulated*)\_\_\_\_\_ iron.
3. The transformer in a solder station (*boosts/lowers*)\_\_\_\_\_ operating voltage to the soldering iron.
4. The temperature of a solder station equipped with a magnetic-thermostat switch is controlled by the type of \_\_\_\_\_ you install.
5. The amount of thermal energy stored by your iron depends (primarily) on the tip's \_\_\_\_\_ and \_\_\_\_\_.
6. To *increase* the thermal storage capacity of an iron, you could: (A.) increase tip temperature, (B.) increase tip mass, (C.) increase tip temperature and mass, (D.) all of the above. [ ]
7. To *decrease* the thermal storage capacity of an unregulated iron, you could: (A.) install a larger tip, (B.) install a smaller heating element, (C.) install a fatter tip, (D.) turn up the voltage. [ ]
8. To *increase* the thermal storage capacity of a continuously adjustable soldering station, you could turn the temperature control (*up/down*) \_\_\_\_\_.
9. If solder melts at the point of tip contact, but not over the entire surface area of the connection, this may indicate your iron has too (*much/little*)\_\_\_\_\_ thermal storage capacity.
10. If pads begin de-laminating and lifting off the pc board when you apply heat, your iron tip might be too: (A.) cool, (B.) fat, (C.) hot, (D.) sharp on the edges. [ ]

## Lesson 5 Soldering Iron Tips

1. The three most popular *types of tip* are the chisel, \_\_\_\_\_-\_\_\_\_\_, and \_\_\_\_\_.
2. Most tip cores are made from \_\_\_\_\_, a soft highly-conductive metal with excellent heat-storage and transfer characteristics.
3. The *entire core* is usually protected by an electroplated layer of \_\_\_\_\_.
4. If electroplate layers are worn or scraped away to expose the core, it will:  
(A.) overheat, (B.) erode quickly, (C.) no longer tin, (D.) smell really bad. [ ]
5. Why electroplate the back portion of a tip with nickel? (A.) adds ballast, (B.) prevents wetting, (C.) provides insulation, (D.) prevents corrosion. [ ]
6. Why electroplate a portion of the outer surface with chrome? (A.) adds ballast, (B.) prevents wetting, (C.) provides insulation, (D.) prevents corrosion. [ ]
7. If you want to solder temperature-sensitive sub-miniature components, it's best to use a (*short/long*)\_\_\_\_\_ tip with a (*wide/narrow*)\_\_\_\_\_ blade.
8. If you want to solder a fat lead to a large land-area on a pc board, it's best to use a (*short/long*)\_\_\_\_\_ tip with a (*wide/narrow*)\_\_\_\_\_ blade.
9. For a *slower rate* of energy transfer, use a (*long/short*)\_\_\_\_\_ and (*skinny/wide*)\_\_\_\_\_ tip.
10. For a *faster rate* of energy transfer, use a (*long/short*)\_\_\_\_\_ and (*skinny/wide*)\_\_\_\_\_ tip.



## ***Lesson 6 Iron and Tip Maintenance***

1. A moistened tip-cleaning sponge should be used (*before/after*)\_\_\_\_- \_\_\_\_\_ making a solder connection.
2. Last thing, before turning off your iron, (A.) clean the tip with a wet sponge. (B.) tin the tip with a thick coating of solder. (C.) dip the tip in flux paste. (D.) dip the tip in cold water to cool it off. [  ]
3. Tip de-tinning may result from: (A.) using small-diameter solder, (B.) using low-flux solder, (C.) operating the iron at higher-than-normal temperatures, (D.) all of the above. [  ]
4. The best way to prevent de-tinning is to use \_\_\_\_\_ flux.
5. (*T/F*) It's okay to use the soldering iron tip to pry solderable surfaces apart. [  ]
6. (*T/F*) If a tip de-tins and resists further wetting, attempt a thorough cleaning and re-tinning procedure before discarding. [  ]
7. Wiping down sponge trays and changing sponges removes what kind of contamination? \_\_\_\_\_
8. It's good to tighten the hardware on your iron, but if you torque screws too hard, the threads may \_\_\_\_\_.
9. (*T/F*) If you find burned insulation on your iron's electrical cord, it's okay to repair it with electrical tape or shrink tubing. [  ]
10. Soldering irons run at high operating temperatures, and this accelerates the process of \_\_\_\_\_ .

## Lesson 7 Soldering Applications

1. For each PC board term (A-G), match a definition by number (1-7):

<b>A.</b> single-sided	<b>1.</b> several PC board layers sandwiched together
<b>B.</b> double-sided	<b>2.</b> conductive pathway between sides of a PC board
<b>C.</b> multi-layered	<b>3.</b> metalized component hole through PC board
<b>D.</b> plate-through	<b>4.</b> leadless surface-mounting component
<b>E.</b> via	<b>5.</b> any component hole through PC board
<b>F.</b> through-hole	<b>6.</b> PC board with two metalized surfaces
<b>G.</b> SMD	<b>7.</b> PC board with one metalized surface

A.\_\_\_\_ B.\_\_\_\_ C.\_\_\_\_ D.\_\_\_\_ E.\_\_\_\_ F.\_\_\_\_ G.\_\_\_\_

- "Raw" copper circuit board patterns are highly solderable, but must be cleaned immediately before construction because of rapid \_\_\_\_\_.
- (T/F) The best way to melt solder onto a connection is to lightly touch the tip of the iron with the solder wire. [ ]
- When soldering to pc-board pads that *aren't* plated through, the primary contact surface is the \_\_\_\_\_.
- When soldering to PC board pads that *are* plated through, the primary contact area is the \_\_\_\_\_.
- Connections made using wire are called \_\_\_\_\_ -to-\_\_\_\_\_ wiring.
- When soldering wires onto a pc board: (A.) dress each lead so insulation is close to the surface of the board. (B.) don't overheat and allow solder to wick up the wires. (C.) install sleeving over exposed shields. (D.) all of the above. [ ]
- If a connection is poor, you'll probably see signs of \_\_\_\_\_, a condition where the solderable surface resists bonding with solder.
- (T/F) The more solder you can deposit on the pad, the better the connection--especially when working with plate-throughs. [ ]
- A "cold solder joint" may result from: (A.) A joint disturbed in its "plastic" phase while cooling. (B.) A connection where one surface was poorly heated. (C.) A connection where solder failed to adhere due to oxidation. (D.) All of the above. [ ]

## ***Lesson 8 Component Handling and Preparation***

1. When reading the value of a resistor, the first two color bands represent the first two digits and the third represents the \_\_\_\_\_.
2. The fourth color band (reading left to right) indicates the resistor's \_\_\_\_\_.
3. If you have a capacitor marked "104", its value will be: (A.) .001uF, (B.) .01uF (C.) .1 uF, (D.) 1.0 uF. [   ]
4. Electrolytic capacitors are polarized and must be oriented correctly on pc boards. When determining polarity, the shorter lead is always (+ or -) \_\_\_\_\_.
5. (T/F) Molded chokes use the same general color-code scheme as resistors. [   ]
6. The banded end of a diode indicates the (*cathode/anode*) \_\_\_\_\_.
7. On an LED, the cathode is the (*longer/shorter*) \_\_\_\_\_ lead.
8. (T/F) Transistors are non-polarized devices that may be installed either way. [   ]
9. When a transistor is packaged in a metal can, the tab on the side of the case marks the (*emitter/base/collector*) \_\_\_\_\_.
10. To find pin #1 on an IC (looking from the top down), first locate the installation key, then move (*clockwise/counter-clockwise*) \_\_\_\_\_ around the device and find the first pin.

## ***Lesson 9 Desoldering for Repair and Replacement***

1. Which is true for the "heat and pull" method of desoldering components? (A.) It is *least* likely to damage the part. (B.) It favors components with three or more leads. (C.) It is likely to damage the part. (D.) It is the most highly recommended way to remove parts. [  ]
2. "Heat and Brush" desoldering is apt to spatter molten solder onto surrounding parts, causing the formation of a \_\_\_\_\_.
3. Solder wick performs better when it is pre-treated with \_\_\_\_\_.
4. If there isn't enough solder on the surface of the connection to start the wicking \_\_\_\_\_ process, \_\_\_\_\_ you \_\_\_\_\_ should \_\_\_\_\_.
5. (T/F) Solder wick is one of the *least recommended* ways to desolder and remove components. [  ]
6. Solder suckers use \_\_\_\_\_ to remove molten solder and deposit it into a container.
7. (T/F) All solder suckers require frequent cleaning and maintenance to prevent clogging and to ensure efficient operation. [  ]
8. When all normal solder-removal techniques fail, the best way to remove solder from a stubborn plate-through hole is with a small \_\_\_\_\_.
9. This medical emergency-room and "OR" implement is also one of the most popular bench tools for clamping and holding small parts or wires. (A.) retractor, (B.) scalpel, (C.) explorer, (D.) hemostat. [  ]
10. This dental tool is great for removing stubborn bits of solder debris or for breaking up solder bridges. (A.) explorer, (B.) scaler, (C.) Novocain, (D.) molar extractor. [  ]

## *Answers to quizzes*

### **Lesson 1**

(1.) strong, low (2.) solid, plastic, liquid or liquidous (3.) A (4.) C (5.) eutectic (6.) C (7.) D (8.) largest, highest (9.) B (10.) A

### **Lesson 2**

(1.) oxides (2.) active (3.) retracts (4.) B (5.) C (6.) D (7.) B (8.) A (9.) D (10.) F

### **Lesson 3**

(1.) acute (2.) chronic (3.) acute (4.) A (5.) infection (6.) electrocution or electric shock (7.) chronic (8.) wash, hands (9.) D (10.) MSDS or Material Safety Data Sheet

### **Lesson 4**

(1.) C (2.) unregulated (3.) lowers (4.) tip (5.) mass, temperature (6.) D (7.) B (8.) up (9.) little (10.) C

### **Lesson 5**

(1.) screwdriver, conical (2.) copper (3.) iron (4.) B (5.) D (6.) B (7.) long, narrow (8.) short, wide (9.) long, skinny (10.) short, wide

### **Lesson 6**

(1.) before (2.) B (3.) D (4.) supplemental or extra (5.) F (6.) T (7.) lead (8.) strip (9.) F (10.) corrosion or oxidation.

### **Lesson 7**

(1.) A7, B6, C1, D3, E2, F5, G4 (2.) oxidation or corrosion (3.) False (4.) pad or pad surface (5.) hole wall, inside of hole (6.) point-to-point (7.) D (8.) retraction (9.) False (10.) D

### **Lesson 8**

(1.) multiplier (2.) tolerance (3.) .1 uF (4.) - or minus (5.) True (6.) cathode (7.) shorter (8.) False!! (9.) emitter (10.) counter-clockwise

### **Lesson 9**

(1.) C (2.) solder bridge (3.) flux (4.) add more (5.) False (6.) vacuum or suction (7.) True (8.) drill (9.) D (10.) B

# VECTRONICS SOLDER COURSE LAB

## *Parts List*

Your kit should contain all of the parts listed below. Please go through the parts bag to identify and inventory each item on the checklist before you start building. If any parts are missing or damaged, refer to the warranty section of this manual for replacement instructions. If you can't positively identify an unfamiliar item in the bag on the basis of the information given, set it aside until all other items are checked off. You may then be able to identify it by process of elimination. Finally, your kit will go together more smoothly if parts are organized by type and arranged by value ahead of time. Use this inventory as an opportunity to sort and arrange parts so you can identify and find them quickly.

<input checked="" type="checkbox"/>	Qty	Part Description	Designation
<input type="checkbox"/>	1	75K-ohm ¼-watt resistor (violet-green-orange)	R2
<input type="checkbox"/>	11	10K-ohm ¼-watt resistor (brown-black-orange-gold)	R4,R5,R6,R7,R8,R9,R10,R11,R12,R13
<input type="checkbox"/>	10	1K-ohm ¼-watt resistor (brown-black-red-gold)	R1,R14,R15,R16,R17,R18,R19,R20, R21,R22,R23
<input type="checkbox"/>	1	1-uF electrolytic capacitor	C1
<input type="checkbox"/>	3	.1-uF monolithic capacitor	C2,C3,C4
<input type="checkbox"/>	10	2N3904 NPN transistor	Q1,Q2,Q3,Q4,Q5,Q6,Q7,Q8,Q9,Q10
<input type="checkbox"/>	1	555 8-pin IC	U1
<input type="checkbox"/>	1	4017 16-pin IC	U2
<input type="checkbox"/>	10	Red LEDs	CR0,CR1,CR2,CR3,CR4,CR5,CR6, CR7,CR8,CR9
<input type="checkbox"/>	1	1N4148 Silicon diode	D1
<input type="checkbox"/>	1	9-volt battery clip	
<input type="checkbox"/>	1	8-pin IC socket	for U1
<input type="checkbox"/>	1	16-pin IC socket	for U2
<input type="checkbox"/>	1	DPDT push-action switch	SW1
<input type="checkbox"/>	5	4" nylon wire tie	
<input type="checkbox"/>	1	30" length of insulated wire	
<input type="checkbox"/>	1	VEC-1500K PC board	

# Parts Placement Diagram

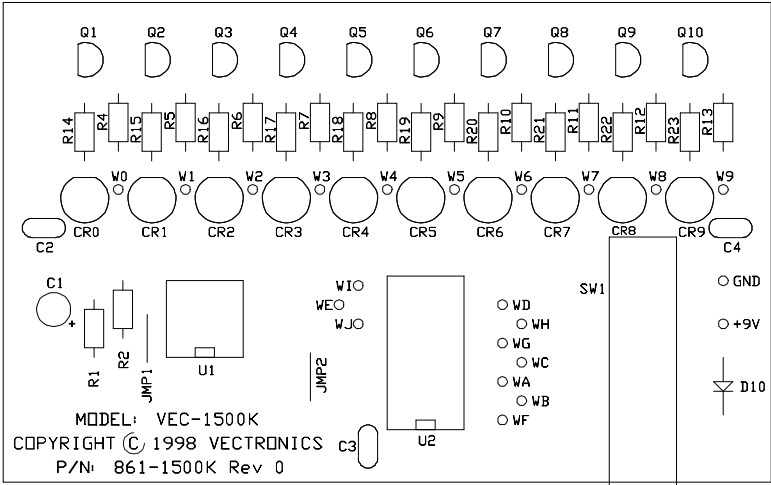

## Step-By-Step Assembly Instructions

First, a few notes and comments to help you along. Part designators for components such as R1, C3, etc., appear in the parts placement diagram. The parts are inserted on the top side of the board; traces are on the bottom side of the board.

Install the monolithic (multilayer) capacitors so their values are easy to read once all the parts are installed. Likewise, orient all fixed-resistor color bands in similar directions. Doing so makes troubleshooting and verifying that no errors were made during assembly easy.

In these instructions, when you see the term *install*, this means to locate, identify, and insert the part into its mounting holes on the PC board. This includes pre-bending or straightening leads as needed so force is not required to seat the part. Once a component is mounted, bend each lead over to hold it in place. Use sharp side-cutters to clip off excess lead length before soldering. Make sure trimmed leads don't touch other pads and tracks, or a short circuit may result:



The term *solder* means to solder the part's leads in place, and to inspect both (or all) solder connections for flaws or solder bridges. Nip off excess protruding leads with a sharp pair of side cutters.

Generally, it's easier to install small close-to-the-board parts first, and then mount larger stand-up parts second. Delicate parts usually go on the PC board last. Concentrate on your soldering while doing the assembly. Don't attempt to rush towards completion of the board--that only defeats the purpose of this course.

*Placing components:* To help you determine the proper location for each part the manual contains a pictorial diagram showing the location of each part on the PC board. Once again, the parts are inserted on the top side of the board; traces are on the bottom side of the board.

Assembly will begin with installing the ¼-watt fixed resistors. Because these are all 5-percent tolerance, ending with a fourth *gold* color band, you need only read the first three bands of the color code during the following steps. All resistor leads should be formed as shown below:

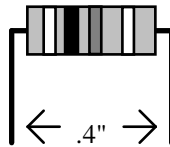

**Note:** Resistors are non-polarized devices. This means they may be installed in any direction on the board. When assembling your board, try to keep all resistor beginning and ending color bands oriented in the same directions. This makes troubleshooting easier, and also produces a neater looking board.

- Locate a 1K-ohm (1000 ohm) resistor (brown-black-red). Form the resistor leads as shown above, and install the resistor at location R1. Use the parts placement diagram for assistance.

The body of the resistor should be resting flat against the PC board surface. Gently bend the leads to hold the resistor package in place (see the example below). Using a pair of fine cutting pliers, trim off the excess lead length.



Leads are bent over to provide a good mechanical connection before soldering.



Based on the work to be done, select a soldering iron with the proper tip and operating temperature, and also the correct solder to make the connection.

- Carefully solder both leads of resistor R1 to the PC board.

Once the soldering operation is completed, carefully examine your work. Is the connection bright and shiny? Has the solder flowed over the resistor lead and the PC board surface (wetting) properly? Has solder splashed onto adjacent runs (*if so, it must be removed*)?

If the joint is poorly soldered, or is grainy in appearance, reheat the work and use solder braid or a solder sucker to remove the solder. Try resoldering the connections again. If the connections are still poor, review your material dealing with soldering techniques.

- When you are satisfied with the soldered connections for the leads of R1, use a pair of fine cutting pliers to trim the remaining lead lengths even with the solder connection.
- Locate the 75K-ohm (75,000 ohm) resistor (violet-green-orange). Install at location R2 on the PC board. Following the steps used for R1, solder and trim the leads for resistor R2.

Locate the ten 10K-ohm resistors (brown-black-orange). These resistors will be installed at locations R4 through R13 on the PC board. Carefully review each solder connection as it is made. Do not proceed with soldering until the previous solder connection is properly made, and any mistakes are corrected. Trim excess lead lengths after completing each soldering operation.

- Install a 10K-ohm resistor (brown-black-orange) at location R4. Solder.
- Install a 10K-ohm resistor (brown-black-orange) at location R5. Solder.
- Install a 10K-ohm resistor (brown-black-orange) at location R6. Solder.
- Install a 10K-ohm resistor (brown-black-orange) at location R7. Solder.
- Install a 10K-ohm resistor (brown-black-orange) at location R8. Solder.
- Install a 10K-ohm resistor (brown-black-orange) at location R9. Solder.

- Install a 10K-ohm resistor (brown-black-orange) at location R10. Solder.
- Install a 10K-ohm resistor (brown-black-orange) at location R11. Solder.
- Install a 10K-ohm resistor (brown-black-orange) at location R12. Solder.
- Install a 10K-ohm resistor (brown-black-orange) at location R13. Solder.

Carefully review your work. Make sure that locations R4 through R13 each contain a 10K-ohm resistor. Examine all of the solder connections. Look for unwanted solder bridges or poorly made solder connections.

Select ten 1K-ohm (1000 ohm) resistors (brown-black-red). These resistors will be installed at locations R14 through R23 on the PC board.

**Note:** save a few of the clipped resistor leads for later use as jumper wires.

- Install a 1K-ohm resistor (brown-black-red) at location R14. Solder.
- Install a 1K-ohm resistor (brown-black-red) at location R15. Solder.
- Install a 1K-ohm resistor (brown-black-red) at location R16. Solder.
- Install a 1K-ohm resistor (brown-black-red) at location R17. Solder.
- Install a 1K-ohm resistor (brown-black-red) at location R18. Solder.
- Install a 1K-ohm resistor (brown-black-red) at location R19. Solder.
- Install a 1K-ohm resistor (brown-black-red) at location R20. Solder.
- Install a 1K-ohm resistor (brown-black-red) at location R21. Solder.
- Install a 1K-ohm resistor (brown-black-red) at location R22. Solder.
- Install a 1K-ohm resistor (brown-black-red) at location R23. Solder.
- Select two of the discarded resistor lead clippings. Form both leads to make jumper wires having a .3" span.

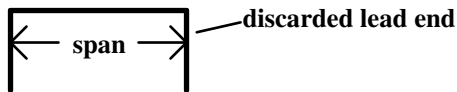

- Install a .3" jumper wire at location JMP1 on the PC board. Solder.
- Install the other .3" jumper wire at location JMP2 on the PC board. Solder.

Locate the 1-uF electrolytic capacitor.

**Important Note:** Electrolytic capacitors are polarized devices, and must be inserted with respect to polarity. The style used in this kit has radial leads; both leads exit from one end of the device body. The capacitor's plus (+) mounting hole is noted on the parts placement diagram. If the markings on the capacitor body are unclear, the plus (+) lead is always the longer of the two.

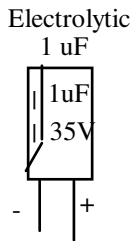

- Observing polarity, install the 1-uF electrolytic at location C1. Solder.

Locate the three .1-uF monolithic capacitors. These capacitors will be installed at locations C2 through C4 on the PC board.

**Important Note:** A monolithic cap is similar to a surface-mount "chip" capacitor, except that it has a lead spot-welded onto each end of the capacitor body. Monolithic caps have superior radio-frequency operating characteristics, but the lead welds *may* fail if the device is over-stressed during installation or removal. For this reason, *never use force to seat a monolithic cap* into the PC board. If the spacing isn't right, pre-form the leads to the correct spacing before installation!



- Install a .1-uF monolithic capacitor at location C2. Solder.
- Install a .1-uF monolithic capacitor at location C3. Solder.

- Install a .1-uF monolithic capacitor at location C4. Solder.

Locate the 1N4148 silicon diode. Note this is a polarized device. The cathode band must be installed as indicated by the parts placement diagram.



- Form the leads of the 1N4148 to a .4" span. Be careful not to stress the glass body, it may crack and fail. Install the 1N4148 diode at location D1 observing polarity. Solder.

Locate the ten 2N3904 plastic transistors. These transistors will be installed at locations Q1 through Q10 on the PC board.

**Important Note:** The 2N3904 transistor body has a flat and rounded side. The device body outline must correspond to the parts placement outline in reference to the PC board.

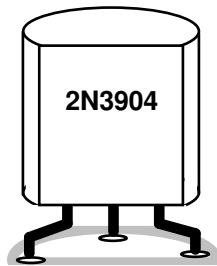

All the transistors should be mounted with their bodies at the same elevation above the PC board.

- Install a 2N3904 transistor at location Q1. Solder.
- Install a 2N3904 transistor at location Q2. Solder.
- Install a 2N3904 transistor at location Q3. Solder.
- Install a 2N3904 transistor at location Q4. Solder.
- Install a 2N3904 transistor at location Q5. Solder.

- Install a 2N3904 transistor at location Q6. Solder.
- Install a 2N3904 transistor at location Q7. Solder.
- Install a 2N3904 transistor at location Q8. Solder.
- Install a 2N3904 transistor at location Q9. Solder.
- Install a 2N3904 transistor at location Q10. Solder.

Locate the ten red LEDs. Observe that the cathode lead is the shorter of the two device leads. The cathode lead is also indicated by a small flat area in the otherwise round base of the device.

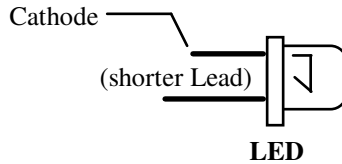

The RED LEDs will be installed at locations CR0 through CR9 on the PC board. Observe cathode lead orientation. All of the LED device bodies should be mounted at the same elevation above the PC board surface. The leads of the diodes are “shouldered”, these should set how high the LEDs sit above the PC board.

- Install a red LED at location CR0. Solder.
- Install a red LED at location CR1. Solder.
- Install a red LED at location CR2. Solder.
- Install a red LED at location CR3. Solder.
- Install a red LED at location CR4. Solder.
- Install a red LED at location CR5. Solder.
- Install a red LED at location CR6. Solder.
- Install a red LED at location CR7. Solder.
- Install a red LED at location CR8. Solder.
- Install a red LED at location CR9. Solder.

Locate the eight-pin DIP IC socket. This is a “low-profile” style socket. Note that the sockets are *keyed* to indicate pins 1 and 8. The key is either a “U” or rectangular shaped notch. The parts placement will indicate proper orientation.

Inspect each socket carefully, and straighten any bent pins before attempting installation.

- Install the eight pin IC socket at location U1 observing orientation. Solder.
- Locate the sixteen-pin low-profile DIP IC socket. Install the 16-pin socket at location U2 observing orientation. Solder.

**Note:** It is very easy to bridge adjacent pins on these sockets because of the very close spacing; be very careful when soldering. If bridges occur, remove them using a solder sucker or solder braid.

- Locate the push-action DPDT (double-pole/double throw) switch. Install the switch at location SW1 on the PC board. The white switch shaft should face the edge of the PC board. The body of the switch should be flush and parallel to the PC board surface. Solder.

Locate the spool of insulated jumper wire. Install the jumpers as directed below:

**Note:** For the following steps you will need to determine the proper wire length needed for each jumper. The jumpers will vary from about 2 inches to 3.5 inches for the longer runs. The wire jumpers should rest on the PC board, in the area between the red LEDs CR0 to CR9, and U1, U2 and SW1. Prepare each jumper by cutting the wire to length. Strip about 1/8" of insulation from each end in preparation for soldering.

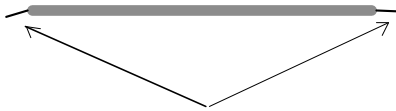

Strip insulation back 1/8-inch from each end.

- Install a jumper between points W8 and WI on the PC board. Solder.
- Install a jumper between points W4 and WE. Solder.
- Install a jumper between points W9 and WJ. Solder.

- Install a jumper between points W3 and WD. Solder.
- Install a jumper between points W7 and WH. Solder.
- Install a jumper between points W6 and WG. Solder.
- Install a jumper between points W2 and WC. Solder.
- Install a jumper between points W0 and WA, Solder.
- Install a jumper between points W1 and WB. Solder.
- Install a jumper between points W5 and WF. Solder.

Locate the 9-volt battery snap.

- Insert the black lead at the point marked “GND” on the parts placement diagram. This is near capacitor C4. Solder.
- The red wire from the battery snap should go the point marked “+9V” on the parts placement diagram, this is near diode D1. Solder.
- Use a 4” nylon wire tie to secure the battery leads to the PC board. The wire tie hole is located near Q10.

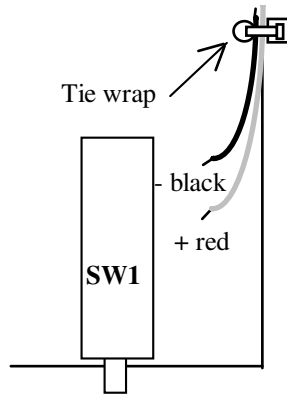

Locate the NE555 timer IC.

**Important Note:** An IC body has a small notch, or *key*, molded at one end, to indicate pin 1. A small dimple-like body-molding is often found adjacent to pin 1. Some IC packages may include both key indicators.

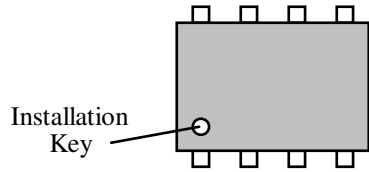
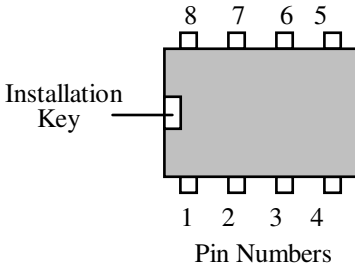

- Align the key on the IC body so it corresponds with the key of socket U1. Loosely insert the pins of the socket into U1. All 8 pins should fit freely into the socket openings. If not, straighten the IC pins until they do. Using firm and steady pressure, fully seat the IC into the socket.

Locate the 4017 IC.

**Note:** The 4017 is a CMOS device, and requires ESD handling precautions.

- Align the key on the IC body so it corresponds with the key of socket U2. Loosely insert the pins of the socket into U2. All 16 pins should fit freely into the socket openings. If not, straighten the IC pins until they do. Using firm and steady pressure, fully seat the IC into the socket.

This completes the assembly portion of the Vectronics VEC-1500K kit. Now is a good time to carefully recheck all of your wiring and soldering. Check that all of the ICs, LEDs, diodes and electrolytic capacitors have been installed correctly.



## ***Operating Instructions***

Connect a fresh battery, and turn the power switch on. The LEDs should immediately begin flashing in sequence.

The “Blinky Light” project was designed especially for this Vectronics soldering course. Sit back and enjoy the array of blinking lights! You have successfully completed your project board.

**Note:** Changing the value of R2 will change the cycle rate of the flashing LEDs.

## ***In Case of Difficulty***

Only high-quality components and proven circuit designs are used in Vectronics kits. In very rare instances is a defective component the source of a problem. Ninety-five percent of the kits returned for factory repair are due to soldering problems or parts in the wrong locations. We advise repeating the assembly instructions step-by-step, looking for mistakes or soldering problems. Be especially wary of electrolytic capacitors and semiconductors. Kit builders often miss obvious mistakes. Sometimes what is needed is a “fresh” set of eyes. You may want to enlist a friend to go over your work.

*Always check the obvious!* Is the battery dead? Is the power switch on?

Connect a fresh battery and turn the power switch on (“ON” is indicated by the switch remaining in the inward position).

Using a voltmeter, nine volts should be present on pins 4 and 8 of U1, and on pin 16 of U2. Use a DC coupled oscilloscope (5-V per division) and check pin 3 of U1 for a pulse train.

1. All LEDs flashing, but not in proper sequence: Check jumper wiring.
2. Some LEDs not lighting: Check jumper wiring. Check LEDs for proper orientation on PC board. Driver transistor installed wrong.
3. LEDs dim, erratic operation: Check battery voltage.

## ***Theory of Operation***

IC U1, a 555 timer, along with resistors R1 and R2, and capacitor C3 form a simple astable multivibrator circuit. The output of U1 on pin 3 is a square wave pulse train with a repetition rate that is variable from about 100 mS to about 10 mS.

The pulse train drives IC U2, a CMOS 4017 decade decoder IC. Each positive going transition of the square wave generated by U1 causes the count of the 4017 to advance by one. The active output of U2 is a high signal level. At any one time, only one of the ten decade outputs will be in a high signal state. A clock cycle begins when the square wave goes high, advancing the count of the 4017 by one.

Each of the decade outputs drives a 2N3904 switching transistor. When the decade output of the 4017 goes high, the associated 2N3904 is driven into conduction. Bias current to the base of the 2N3904 is limited by a 10K resistor. When the transistor base is forward biased by the decade output, the transistor is driven into saturation, or full conduction. This provides a return path to ground for the Light Emitting Diode (LED), through a 1K current limiting resistor, at the transistor collector.

## ***Specifications***

- Power Requirements .....Nine volt transistor battery at about 15 mA.  
Circuit will operate over a 6 to 15 VDC supply range.
- Flash Rate .....About 100mS to 10mS sequence.

# Schematic

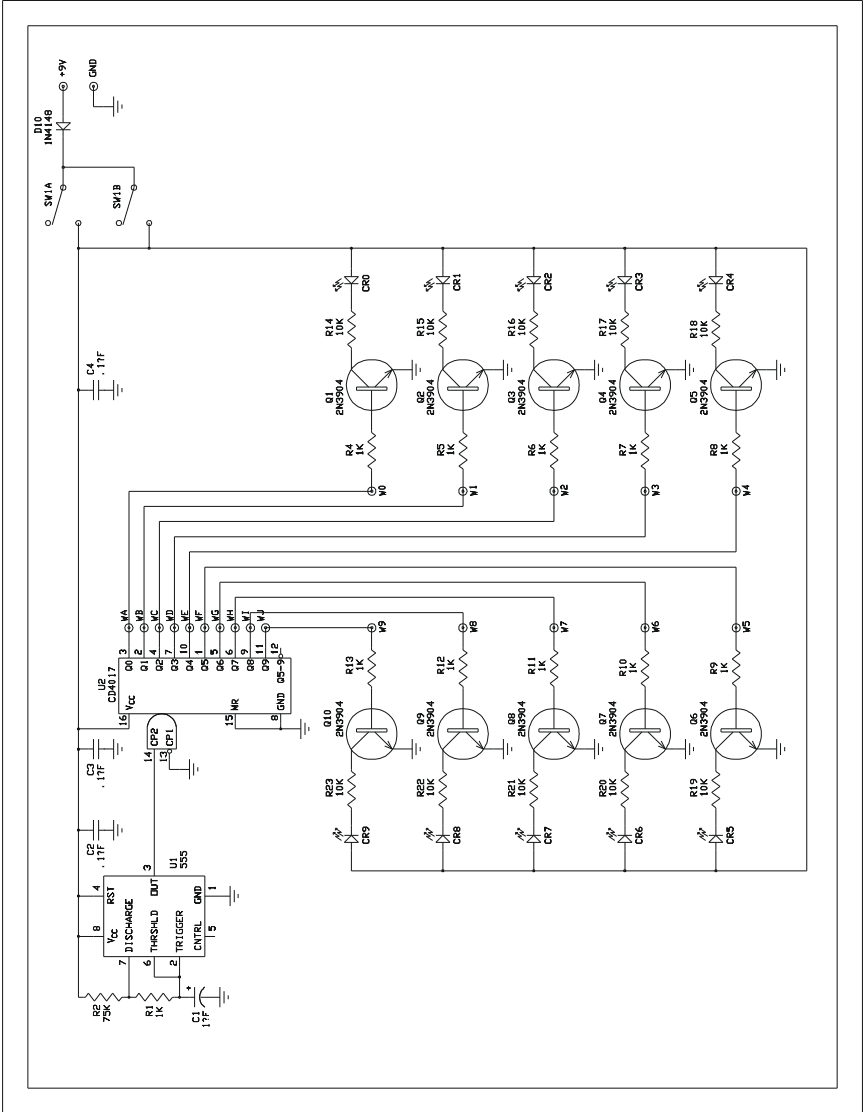

## VEC-1500K



*High-performance electronic kits . . . fun to build and use!*

**Kit building** is a super fun way to spend a quiet evening or weekend. You'll find it extremely satisfying to build your own electronic equipment. You'll have a useful electronic gadget that you can show off once you're through. You'll cherish it for years because *you built it yourself!* From shortwave converters to aircraft receivers and ham radio kits to an old fashioned crystal radio kit, you'll find many fun items in the **VECTRONICS** kit line for you.

**VECTRONICS** kits work! They're created by engineers who are hobbyists-at-heart to give you what you want -- a professional product at a hobby price. Each kit features a professional quality epoxy glass PC board with solder mask and screen printed component legend, simple step-by-step instruction manual and the highest quality components. Kit assembly is easy, and they work the first time.

**Don't** forget about our custom cabinets -- they turn your kit into a show piece that your friends won't believe that *you* built.

With **VECTRONICS** kits you get satisfaction, relaxation, and a super fun product you'll be proud to use . . . *because you made it yourself!*

**VECTRONICS** has a worldwide reputation of building the finest quality amateur radio products made. You can trust our 25 years of experience to deliver super quality, high-performance kits.

All **VECTRONICS** electronic hobby kits are designed and kitted in the USA . . . *and built by you!*

### OTHER **VECTRONICS** hobby KITS:

VEC-121K Crystal Radio Set	VEC-830K Super SSB Filter	VEC-1180K 80 Meter Receiver	VEC-1402K 2 Meter Preamp
VEC-131K Aircraft Receiver	VEC-841K Tunable CW Filter	VEC-1202K 2M Transmitter	VEC-1422K 220 MHz Preamp
VEC-201K CW Keyer	VEC-1002K 2 Meter Receiver	VEC-1220K 20M Transmitter	VEC-1444K 440 MHz Preamp
VEC-221K Memory Keyer	VEC-1006K 6 Meter Receiver	VEC-1230K 30M Transmitter	VEC-1402DK Super 2M Preamp
VEC-412K Battery Charger	VEC-1010K 10 Meter Receiver	VEC-1240K 40M Transmitter	VEC-1500K Soldering Course
VEC-422K SCA Decoder	VEC-1102K 20 Meter Receiver	VEC-1280K 80M Transmitter	VEC-1680K Vacuum Tube Preamp
VEC-820K CW Filter	VEC-1130K 30 Meter Receiver	VEC-1290K Radio Transmitter	VEC-4001K Function Generator
VEC-821K Super CW Filter	VEC-1140K 40 Meter Receiver	VEC-1294K TV Transmitter	VEC-8210K Stress Level Monitor