

IMPORTANT WARRANTY INFORMATION! PLEASE READ

Return Policy on Kits When *Not* Purchased Directly From Vectronics: Before continuing any further with your VEC kit check with your Dealer about their return policy. If your Dealer allows returns, your kit must be returned *before* you begin construction.

Return Policy on Kits When Purchased Directly From Vectronics: Your VEC kit may be returned to the factory *in its pre-assembled condition only*. The reason for this stipulation is, once you begin installing and soldering parts, you essentially take over the role of the device's manufacturer. From this point on, neither Vectronics nor its dealers can reasonably be held accountable for the quality or the outcome of your work. Because of this, Vectronics cannot accept return of any kit-in-progress or completed work as a warranty item for any reason whatsoever. If you are a new or inexperienced kit builder, we urge you to read the manual carefully and determine whether or not you're ready to take on the job. If you wish to change your mind and return your kit, you may--but you must do it *before* you begin construction, and within ten (10) working days of the time it arrives.

Vectronics Warrants: Your kit contains each item specified in the parts list.

Missing Parts: If you determine, during your pre-construction inventory, that any part is missing, please contact Vectronics and we'll send the missing item to you free of charge. However, *before* you contact Vectronics, *please look carefully* to confirm you haven't misread the marking on one of the other items provided with the kit. Also, make certain an alternative part hasn't been substituted for the item you're missing. If a specific part is no longer available, or if Engineering has determined that an alternative component is more suitable, Vectronics reserves the right to make substitutions at any time. In most cases, these changes will be clearly noted in an addendum to the manual.

Defective Parts: Today's electronic parts are physically and electrically resilient, and defective components are rare. However, if you discover an item during your pre-construction inventory that's obviously broken or unserviceable, we'll replace it. Just return the part to Vectronics at the address below accompanied with an explanation. Upon receipt, we'll test it. If it's defective and appears unused, we'll ship you a new one right away at no charge.

Missing or Defective Parts After You Begin Assembly: Parts and materials lost or damaged *after construction begins* are not covered under the terms of this warranty. However, most parts supplied with VEC kits are relatively inexpensive and Vectronics can replace them for a reasonable charge. Simply contact the factory with a complete description. We'll process your order quickly and get you back on track.

Factory Repair After You Begin Assembly: *Kits-in progress and completed kits are specifically excluded from coverage by the Vectronics warranty.* However, as a service to customers, technicians are available to evaluate and repair malfunctioning kits for a minimum service fee of \$18.00 (½ hour rate) plus \$7.00 shipping and handling (prices subject to change). To qualify for repair service, your kit must be fully completed, unmodified, and the printed circuit board assembled using rosin-core solder. In the event your repair will require more than an hour to fix (or \$36.00, subject to change), our technicians will contact you in advance by telephone before performing the work. Defective units should be shipped prepaid to:

Vectronics
300 Industrial Park Road
Starkville, MS 39759

When shipping, pack your kit well and include the minimum payment plus shipping and handling charges (\$25.00 total). No work can be performed without pre-payment. Also, provide a valid UPS return address and a day time phone number where you may be reached.

INTRODUCTION

General Information: Personal CD players are famous for bringing concert-hall ambiance and bone-rattling realism to private listening. However, there are times when headphone isolation and dangling cords makes it difficult to carry on a conversation, share the music, hear the phone ring, or perform other activities. This great little CD amp helps you get beyond that limitation, extending the usefulness of your player and turning it into a mini-stereo system. Use it in your dorm room, at the beach, on the patio, in the workshop--anywhere a full-sized stereo can't be found! Circuitry uses two high-quality amplifier ICs--just like those used in car stereo systems. You'll love the full-bodied sound this project delivers!

Circuitry: Your VEC-1604K uses two (2) TDA1013 4-Watt monolithic audio ICs (one per channel). Each IC provides both a pre-amp and power amp to boost weak headphone level signals up to robust speaker levels. Volume for each channel is controlled individually to maintain stereo balance, while tone is set by a single control. Use a 12-volt battery, automotive electrical system, or AC power-adaptor--and DC source from 12 to 24 Volts--to run your amp. Works with any 8 to 16-Ohm speaker system capable of handling at least 4 Watts RMS per channel.

TOOLS AND SUPPLIES

Construction Area: Kit construction requires a clean, smooth, and well-lighted area where you can easily organize and handle small parts without losing them. An inexpensive sheet of white poster board makes an excellent construction surface, while providing protection for the underlying table or desk. Diffused overhead lighting is a plus, and a supplemental high-intensity desk lamp is especially helpful for close-up work. Safety is always important! Use a suitable high-temperature stand for your soldering iron, and keep the work area free of clutter.

Universal Kit-building Tools: No special tools are required to complete this kit beyond common items normally used for bench construction. We recommend the following:

- Soldering Iron (grounded-tip and temperature-controlled preferred)
- High-temperature Iron Holder with Cleaning Sponge
- Solder, 60/40 or 37/63 with rosin or "no-clean" flux (.031" dia. is good size).
- Needle Nose Pliers or Surgical Hemostats

- Diagonal Cutters or "Nippy Cutters"
- Solder Sucker (squeeze or vacuum pump type), or Desoldering Braid
- Bright Desk Lamp
- Magnifying Glass

BEFORE YOU START BUILDING

Experience shows there are *four common mistakes* builders make. Avoid these, and your kit will probably work on the first try! Here's what they are:

- 1. Installing the Wrong Part:** It always pays to double-check each step. A 1K and a 10K resistor may look *almost* the same, but they may act very differently in an electronic circuit! Same for capacitors--a device marked 102 (or .001 uF) may have very different operating characteristics from one marked 103 (or .01uF).
- 2. Installing Parts Backwards:** Always check the polarity of electrolytic capacitors to make sure the positive (+) lead goes in the (+) hole on the circuit board. Transistors have a flat side or emitter tab to help you identify the correct mounting position. ICs have a notch or dot at one end indicating the correct direction of insertion. Diodes have a banded end indicating correct polarity. Always double-check--especially before applying power to the circuit!
- 3. Faulty Solder Connections:** Inspect for cold-solder joints and solder bridges. Cold solder joints happen when you don't fully heat the connection--or when metallic corrosion and oxide contaminate a component lead or pad. Solder bridges form when a trail of excess solder shorts pads or tracks together (see Solder Tips below).
- 4. Omitting or Misreading a Part:** This is easier to do than you might think! Always double-check to make sure you completed each step in an assembly sequence.

Soldering Tips: *Cleanliness* and good *heat distribution* are the two secrets of professional soldering. Before you install and solder each part, inspect leads or pins for oxidation. If the metal surface is dull, sand with fine emery paper until shiny. Also, clean the oxidation and excess solder from the soldering iron tip to ensure maximum heat transfer. Allow the tip of your iron to contact both the lead and pad for about one second (count "one-thousand-one") before feeding solder to the connection. Surfaces must become hot enough for solder to *flow smoothly*. Feed solder to the opposite side of the lead from your iron tip--solder will wick around the lead toward the tip, wetting all exposed surfaces. Apply

solder sparingly, and do not touch solder directly to the hot iron tip to promote rapid melting.

Desoldering Tips: If you make a mistake and need to remove a part, follow these instructions carefully! First, grasp the component with a pair of hemostats or needle-nose pliers. Heat the pad beneath the lead you intend to extract, and pull gently. The lead should come out. Repeat for the other lead. Solder may fill in behind the lead as you extract it--especially if you are working on a double-sided board with plate-through holes. Should this happen, try heating the pad again and inserting a common pin into the hole. Solder won't stick to the pin's chromium plating. When the pad cools, remove the pin and insert the correct component. For ICs or multi-pin parts, use desoldering braid to remove excess solder before attempting to extract the part. Alternatively, a low-cost vacuum-bulb or spring-loaded solder sucker may be used. Parts damaged or severely overheated during extraction should be replaced rather than reinstalled.

Work Habits: Kit construction requires the ability to follow detailed instructions and, in many cases, to perform new and unfamiliar tasks. To avoid making needless mistakes, work for short periods when you're fresh and alert. Recreational construction projects are more informative and more fun when you take your time. Enjoy!

Sorting and Reading Resistors: The electrical value of resistors is indicated by a color code (shown below). You don't have to memorize this code to work with resistors, but you do need to understand how it works:

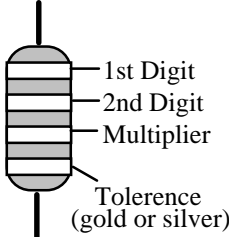
Resistor Color Code		
	Black = 0 (tens)	Blue = 6
	Brown = 1 (hundreds)	Violet = 7
	Red = 2 (K)	Gray = 8
	Orange = 3 (10K)	White = 9
	Yellow = 4 (100K)	Silver = 10%
	Green = 5 (1Meg)	Gold = 5%

When you look at a resistor, check its multiplier code first. Any resistor with a black multiplier band falls between 10 and 99 ohms in value. Brown designates a value between 100 and 999 ohms. Red indicates a value from 1000 to 9999 ohms, which is also expressed as 1.0K to 9.9K. An orange multiplier band designates 10K to 99K, etc. To sort and inventory resistors, first separate them into groups by multiplier band (make a pile of 10s, 100s, Ks, 10Ks, etc.). Next, sort each group by specific value (1K, 2.2K, 4.7K, etc.). This procedure makes the inventory easier, and also makes locating specific parts more convenient later.

on during construction. Some builders find it especially helpful to arrange resistors in ascending order along a strip of double-sided tape.

Reading Capacitors: Unlike resistors, capacitors no longer use a color code for value identification. Instead, the value, or a 3-number code, is printed on the body.

Value	Code			
10 pF	= 100			
100 pF	= 101			
1000 pF	= 102			
.001 uF	= 102*			
.01 uF	= 103			
.1 uF	= 104			

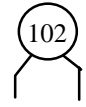
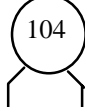
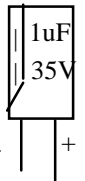
Multilayer (270 pF)	Ceramic Discs (.001 uF) (.1 uF)		Electrolytic 1 uF
			

As with resistors, it's helpful to sort capacitors by type, and then to arrange them in ascending order of value. Small-value capacitors are characterized in pF (or pico-Farads), while larger values are labeled in uF (or micro-Farads). The transition from pF to uF occurs at 1000 pF (or .001 uF)*. Today, most monolithic and disc-ceramic capacitors are marked with a three-number code. The first two digits indicate a numerical value, while the last digit indicates a multiplier (same as resistors).

Electrolytic capacitors are always marked in uF. Electrolytics are polarized devices and must be oriented correctly during installation. If you become confused by markings on the case, remember the uncut negative lead is slightly shorter than the positive lead.

Integrated Circuits: Proper IC positioning is indicated by a dot or square marking located on one end of the device. A corresponding mark will be silk-screened on the PC board and printed on the kit's parts-placement diagram. To identify specific IC pin numbers for testing purposes, see the diagram below. Pin numbers always begin at "1" at the keyed end of the case and progress along the device, as shown:

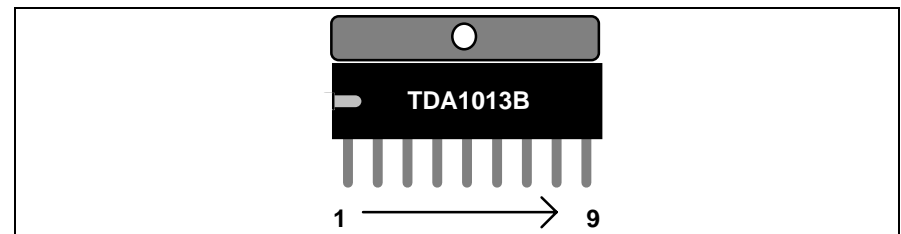

PARTS LIST

Your kit should contain all of the parts listed below. Please identify and inventory each item on the checklist before you start building. If any parts are missing or damaged, refer to the manual's warranty section for replacement instructions. If you can't positively identify an unfamiliar item on the basis of the information given, set it aside until all other items are checked off. You may then be able to identify it by process of elimination. Finally, your kit will go together more smoothly if parts are organized by type and arranged by value ahead of time. Use this inventory as an opportunity to sort and arrange parts so you can identify and find them quickly.

<input checked="" type="checkbox"/>	Qty	Part Description	Designation	VEC P/N
<input type="checkbox"/>	2	1.5 ohm resistor (brn-grn-gold)	R9,R10	100-0150
<input type="checkbox"/>	2	1K ohm resistor (brn-blk-red)	R11,R12	100-3100
<input type="checkbox"/>	2	5.1K ohm resistor (grn-brn-red)	R4,R6	100-3510
<input type="checkbox"/>	2	51K ohm resistor (grn-brn-org)	R3,R5	100-4510
<input type="checkbox"/>	2	100K ohm resistor (brn-blk-yel)	R7,R8	100-5100
<input type="checkbox"/>	2	10K potentiometer (B10K)	R1,R2	153-4100-1
<input type="checkbox"/>	1	500K dual potentiometer (B504)	R13	153-5500-12
<input type="checkbox"/>	3	.1 uF disc ceramic capacitor (104)	C7,C8,C13	200-3100-1
<input type="checkbox"/>	2	10 uF electrolytic capacitor	C9,C10	270-5100-1
<input type="checkbox"/>	2	470 uF electrolytic capacitor	C11,C12	270-6470-1
<input type="checkbox"/>	2	.0068 uF multilayer capacitor	C1,C3	220-1680
<input type="checkbox"/>	2	.047 uF multilayer capacitor	C2,C4	220-2470
<input type="checkbox"/>	2	.33 uF multilayer capacitor	C5,C6	220-3330B
<input type="checkbox"/>	1	TDA1013B IC	U1,U2	324-1013
<input type="checkbox"/>	1	DPDT push-button switch	SW2	504-2022
<input type="checkbox"/>	3	3.5mm stereo jack	J1,J2,J3	601-5005
<input type="checkbox"/>	1	2.1mm coaxial-type jack	J4	601-6121B
<input type="checkbox"/>	1	2" length of insulated wire (red)		871-2400-1200
<input type="checkbox"/>	2	12" length of insulated wire		871-2422-0200
<input type="checkbox"/>	1	VEC-1604 pc board		861-VEC1604
<input type="checkbox"/>	1	Owner's manual		925-VEC1604K

PARTS PLACEMENT

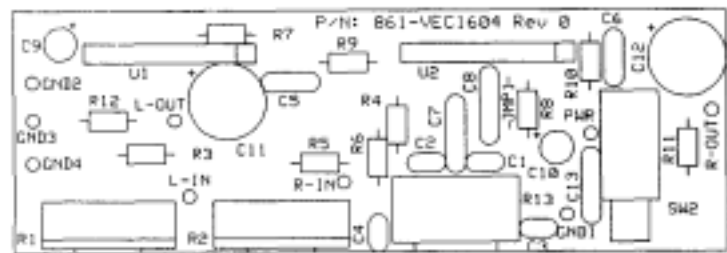

STEP-BY-STEP ASSEMBLY INSTRUCTIONS

In these instructions, when you see the term *install*, this means to locate, identify, and insert the part into its mounting holes on the PC board. This includes pre-bending or straightening leads as needed so force is not required to seat the part. Once a component is mounted, bend each lead over to hold it in place. Use sharp side-cutters to clip off excess lead length before soldering. Make sure trimmed leads don't touch other pads and tracks, or a short circuit may result:



The term *solder* means to solder the part's leads in place, and to inspect both (or all) solder connections for flaws or solder bridges. Nip off excess protruding leads with a sharp pair of side cutters.

Notice that the directions use a set of check boxes. Check one when a step is complete and use the other for double-checking your work before operation.

This kit has 10 fixed-value resistors. Mount these now, starting with the smallest value and moving to the largest. Before mounting each one, carefully bend both leads close to the resistor body to form right-angles, as shown below:

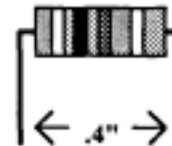

1. Install a 1.5 ohm resistor at R9 and solder.

2. Install a 1.5 ohm resistor at R10 and solder.

Find two (2) 1K resistors (brown-black-red).

3. Install a 1K resistor at R11 and solder.

4. Install a 1K resistor at R12 and solder.

Find two (2) 5.1K resistors (green-brown-red).

5. Install a 5.1K resistor at R4 and solder.

6. Install a 5.1K resistor at R6 and solder.

Find two (2) 51K resistors (green-brown-orange).

7. Install a 51K resistor at R3 and solder.

8. Install a 51K resistor at R5 and solder.

Find two (2) 100K resistors (brown-black-yellow).

9. Install a 100K resistor at R7 and solder.

10. Install a 100K resistor at R8 and solder.

This completes installation of the 10 fixed-value resistors (three variable resistors will be installed later). Take a moment to confirm each one is positioned in the right location on the PC board.

Now is a good time to install JMP1. Use a clipped resistor lead to make this jumper.

11. Install a jumper wire at JMP1. The wire should lay on top of the text "JMP1".

Next, we'll install the kit's 13 capacitors--starting with the disc-ceramic types.

Find three (3) .1 uF disc ceramic capacitors (marked 104).

12. Install a .1 uF capacitor at C7 and solder.

13. Install a .1 uF capacitor at C8 and solder.

14. Install a .1 uF capacitor at C13 and solder.

There are 6 multilayer capacitors provided with your kit. A multilayer capacitor is similar to a surface-mount "chip" capacitor, except that it has a lead spot-welded onto each end of the capacitor body. Multilayers are very small and take up less space than other capacitor types. However, lead welds *may* fail if the device is over-stressed during installation or removal. For this reason, *never use*

force to seat a multilayer capacitor into the PC board. If the spacing isn't right, pre-form the leads to the correct spacing before installation!

Find two (2) .0068 uF multilayer capacitors (marked 682).

15. Install a .0068 uF capacitor at C1 and solder.

16. Install a .0068 uF capacitor at C3 and solder.

Find two (2) .047 uF multilayer capacitors (marked 473).

17. Install a .047 uF capacitor at C2 and solder.

18. Install a .047 uF capacitor at C4 and solder.

Find two (2) .33 uF multilayer capacitors (marked 334).

19. Install a .33 uF capacitor at C5 and solder.

20. Install a .33 uF capacitor at C6 and solder.

This completes installation of the 6 multilayer caps.

The last (4) capacitors in your kit are electrolytic. ***Electrolytic caps are polarized and must be installed the correct way in order to work.*** Each capacitor's plus (+) mounting holes are noted on both the circuit board and parts placement diagram. If the markings on the capacitor body are unclear, the plus (+) lead is always the longer of the two.

Find two (2) 10 uF electrolytic capacitors. Identify the (+) lead on each.

21. Install a 10 uF capacitor at C9 and solder.

22. Install a 10 uF capacitor at C10 and solder.

Find two (2) 470 uF electrolytic capacitors. Identify the (+) lead on each.

23. Install a 470 uF capacitor at C11 and solder.

24. Install a 470 uF capacitor at C12 and solder.

This completes installation of all capacitors. Before moving on to the next phase of construction, check the polarity of each electrolytic one more time to confirm all four are installed correctly.

The front-panel controls (volume & tone) are mounted next. Before installing these parts, inspect the type of potentiometer supplied with your kit. If the pins are located on the *front* side of the pot, use the *front set of mounting holes* on the PC board for installation. If the pins are on the *rear*, use the *rear set of mounting holes* (see the following diagram). Also, using side cutters, remove the key tab from the side of each pot prior to installation.

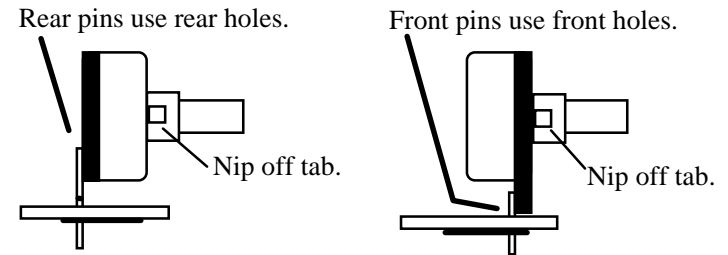

Find two (2) 10K potentiometers (marked B10K or B103K). Inspect for pin location (as described previously) and locate the appropriate mounting holes on the PC board.

25. Install a 10K pot at R1 and solder.

26. Install a 10K pot at R2 and solder.

Find the dual-section 500K pot (marked B504K). No alternative pin locations are provided for this style control.

27. Install the dual-section 500K pot at R13 and solder.

Your kit contains a miniature DPDT switch. Some versions require installation of a plastic clip-on support at the front of the switch body. This piece relieves stress on the pins and ensures level seating during installation. If your parts kit contains this piece, install as shown:

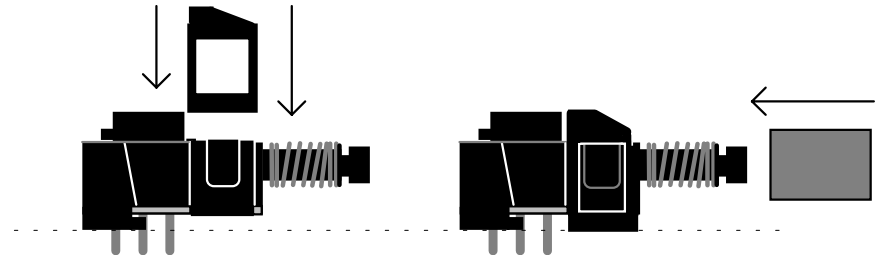

Your switch should also have a red cap supplied with it. Install this on the push-button shaft. Once the switch is prepared for installation:

28. Install the DPDT mini switch at SW2 and solder.

The two last PC board mounted components are the AF amplifier ICs, U1 and U2. Find these devices (marked TDA1013B). Before installing, inspect both carefully and straighten any bent or crooked pins. Use extreme care during IC pin insertion and move slowly. It's easy to miss a mounting hole and fold a pin underneath the body.

- 29. Find a TDA1013B and identify its keyed end. Now, find the mounting holes for U1 and identify the keyed end on the silkscreen pattern. Align U1 so it corresponds with the silkscreen pattern and insert, checking carefully that all 9 pins enter their respective mounting holes. Solder all 9 pins.
- 30. Repeat the above procedure, installing a TDA1013B at U2. Solder all 9 pins.

Installing the amplifier's power and audio connectors involves point-to-point wiring, where you'll prepare and install installed wires connecting the jacks to the PC board. Find the hookup wire provided with your kit. After cutting each wire to its specified length, prepare it for installation by removing 1/4" of insulation from each end.

Locate a 12" length of insulated wire:

- 31. Cut and prep a 2-1/2" length of insulated wire. Install one end at GND4 and solder.
- 32. Cut and prep a 3" length of insulated wire. Install one end at GND3 and solder.
- 33. Cut and prep a 4" length of insulated wire. Install one end at GND2 and solder.
- 34. Cut and prep a 2" length of insulated wire. Install one end at GND1 and solder.
- 35. Locate the 2" length of red wire. Install one end at PWR and solder.

Locate three (3) 3.5-mm stereo jacks. Find the common (or GND) terminal using the following diagram. Follow the installation detail when connecting leads to jacks.

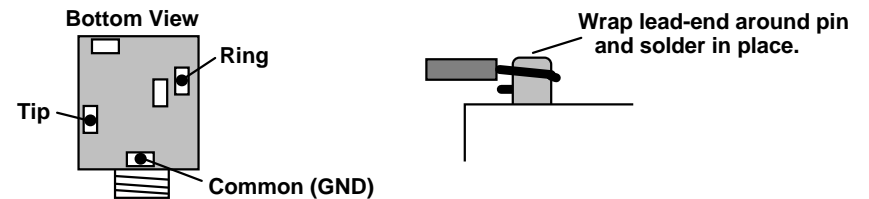

The first connector you'll install is the Left-Channel Speaker Jack:

- 36. Find the 2-1/2" insulated wire connected to GND4. Solder the free end to the common or GND tab on a 3.5-mm stereo jack.
- 37. Cut and prep a 2-1/2" length of insulated wire. Connect one end to L-OUT and solder.

- 38. Connect the free end of the insulated wire from L-OUT to the TIP tab on the jack.

Next, install the Right-Channel Speaker Jack:

- 39. Find the 3" length of insulated wire connected to GND3. Solder the free end to the common or GND tab on a 3.5-mm stereo jack.
- 40. Cut and prep a 4" length of insulated wire. Connect one end to R-OUT and solder.
- 41. Connect the free end of the insulated wire from R-OUT to the TIP tab on the jack.

Finally, install the CD-Player Stereo Input connector.

- 42. Find the 4" length of insulated wire connected to GND2. Solder the free end to the common or GND tab on the last 3.5-mm stereo jack.
- 43. Cut and prep a 3-1/2" length of insulated wire. Connect one end to L-IN and solder.
- 44. Connect the free end of the insulated wire from L-IN to the TIP tab and solder.
- 45. Cut and prep a 2" length of insulated wire. Connect one end to R-IN and solder.
- 46. Connect the free end of the insulated wire from R-IN to the RING tab and solder (see diagram).

If you have the companion VEC-1604KC cabinet kit, you'll mount the 2.1-mm power jack in the panel *prior to* connecting the power leads to from the PC board. If you plan to install your kit in a different box, go ahead and install the power jack at this time so you can test your unit. The power jack has three solder tabs on the back, as shown below:

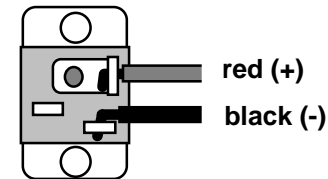

- 47. Find the 2" red wire connected to PWR. Connect the free end to the (+) tab of the power jack, as shown. Solder.
- 48. Find the 2-1/2" length of insulated wire connected to GND1. Connect the free end to the (-) tab of the power jack, as shown. Solder.

This concludes assembly of your VEC-1604K CD-Player Amplifier kit. Check your work thoroughly before proceeding to the Testing and Alignment section of the manual.

TESTING AND ALIGNMENT

There's no internal alignment required with this kit. To test the circuit board for proper operation prior to installation in a cabinet, connect as shown:

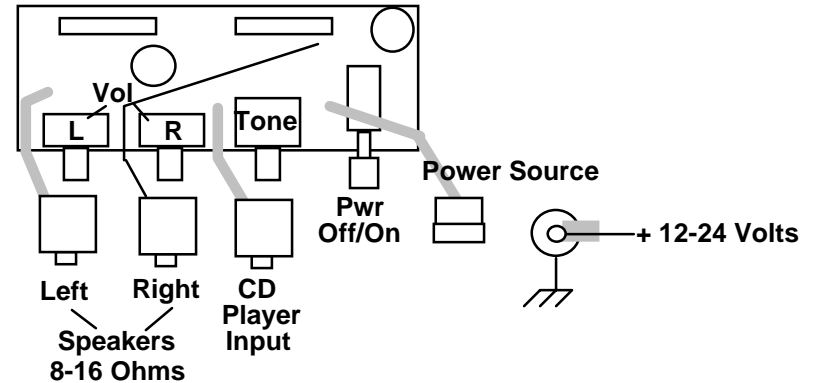

Speaker and CD Player Connections: Speaker output jacks require plugs configured for monaural wiring. Be sure to wire stereo speakers in phase with (+) to tip, (-) to common or ground. The CD Player Input jack requires a stereo plug configured for normal stereo wiring:

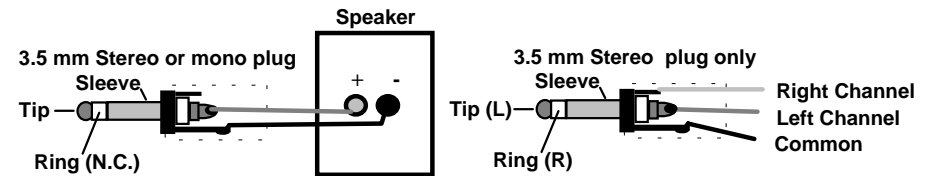

When conducting initial tests, *start with all volume controls set at minimum* to prevent the speakers from blasting when turning your unit on. The volume controls on your CD player and amp will interact. Usually its best to adjust the player so that full volume setting on your amp correspond with maximum undistorted output.

Important Note: Your amplifier ICs are not outfitted with external heatsinks. Experience shows heatsinks are not generally needed for casual listening. However, if you operate your amplifier at high volume levels for extended periods of time or connect it to 4-Ohm speakers, IC1 and IC2 may overheat. If this occurs, you may add a heatsink easily by cutting a single 3" x 1-1/2" piece of

aluminum and bolting it to the tabs of IC1 and IC2. Space your mounting holes 1.65" apart and use 4-40 mounting hardware.

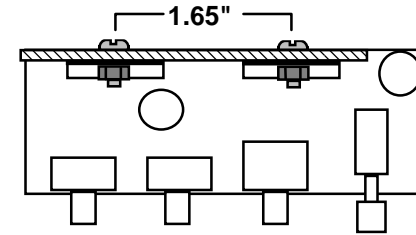

Power Connections: The power jack requires a standard 2.1 mm plug. You may obtain extras at Radio Shack under part number RS 274-1567. Wire (+) to the center terminal and (-) to the sleeve.

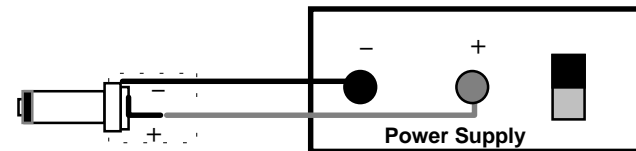

Important Note: Your amplifier isn't protected against reverse-polarity power lead connections. To avoid the possibility of damaging your amp, *always double-check your power connection lead polarity before applying power.*

OPERATING INSTRUCTIONS

Operation of your amplifier is simple. Connect the speakers and CD player as directed, and adjust controls for your listening preference. For more complete set-up and operating instructions, refer back to the previous section.

IN CASE OF DIFFICULTY

Before seeking outside assistance, check the list below for a possible solution:

Does not turn on: Check battery condition, snap clip, and power leads. Also, make sure lead polarity is correct (red to +, black to GND). Make sure power switch is "on".

Check operating voltages.

No Sound: Check all cables to and from your amp. Look for wiring errors, shorts or open leads.

Sound Distorted: Check CD Player volume. If this is too high, distortion may result. Also, operating voltage may be too low or battery condition poor. Finally, speakers may be damaged or unable to handle power provided by your amp.

Insufficient Volume: Check CD Player volume. If this is too low, insufficient drive may be available for your amplifier. Also, check speaker wiring.

Insufficient Bass Response: Check speaker phasing.

If these checks fail to uncover the problem, repeat the "QC" check one more time. Service records show that, for most malfunctioning kits, outright component failure is relatively rare. In most cases, the culprit is a misplaced part, reverse-polarized capacitor, improperly installed IC, or a faulty solder connection. If, despite your best effort, you cannot solve the problem, kit repair services are available through Vectronics. See the warranty on the inside front cover for complete instructions.

THEORY OF OPERATION AND SPECIFICATIONS

Referring to the schematic, your VEC-1604K amplifier uses two (2) identical pre-amp/power-amp ICs--one for each channel. For the left channel, volume is controlled via a voltage divider (potentiometer R1). The divider output feeds a fixed attenuator (R3, R4) to further reduce headphone level signals from the CD player. A bridge-type tone control consisting of R13, C1, and C2 provides adjustable attenuation of bass frequencies prior to amplification. U1 then boosts the AF signal and provides power amplification for speaker-level output. Output is single-ended with DC isolation provided by coupling capacitor C11. Snubber circuit R9, C5 prevents high-frequency oscillation due to reactive speaker loads. R12 provides a "safety" load to prevent over-voltage damage if no speaker is connected. Vcc-line filtering is electronic, using R8 and C9 to establish the proper LF time constant. Right channel circuitry is identical to the left.

SCHMATIC

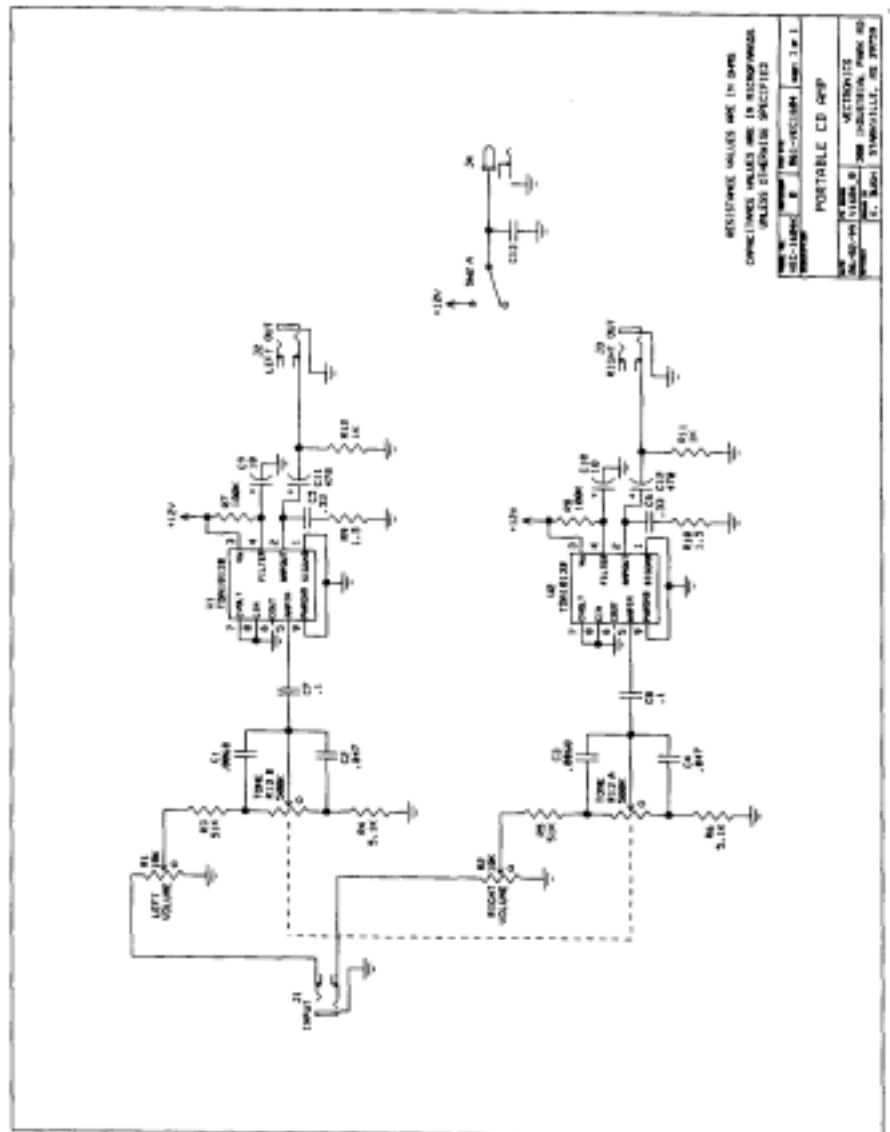

ENCLOSURE

To install your CD amp in the VEC-1604KC matching enclosure follow these instructions (*read all instructions before beginning ... take your time*):

1. Find the front panel decal and trim. Be sure to leave excess decal material around the edges. Put the front panel decal on. This is done by: **a.)** Remove all debris and oil from the face plate. This should be done using a piece of cloth and alcohol. **b.)** Remove the crack and peel to expose the adhesive. **c.)** Place the decal on the front panel without securing it completely. **d.)** Gently rub the alignment circles with your finger--if the circles are centered in the enclosure holes (also check the corner alignment marks) secure the decal by rubbing and removing all air bubbles. **e.)** If the alignment circles are not centered, adjust the decal accordingly, then secure. **f.)** Use a penknife, or small Exacto™ knife, to cut away the unused edges (*cut from the adhesive side*) and cut out the component holes (*cut from the description side*).
2. Install the 2.1mm power jack. Find the two 3/8" small screws and the appropriate nuts. Insert the jack so that the mounting holes line up, and tighten the nuts onto the screws.
3. Now insert the PC board. This must be done by: **a.)** Remove the nuts and washers from R1, R2, and R13. **b.)** Insert the front of the PC board so the controls enter their respective holes. **c.)** Place the washers and nuts onto the potentiometers and tighten. Ensure that the switch is aligned properly.
4. Install the three 3.5mm stereo jacks into the respective holes. This must be done by: **a.)** Remove the nuts from J1, J2, and J3. **b.)** Ensure that the left output (J2), right output (J3), and stereo input (J1) jacks are inserted into the correct positions. **c.)** Place the nuts onto the three jacks and tighten.
5. Find the knobs. Now put the knobs on R1, R2, and R13. You may need to loosen the set screw. Align appropriately then tighten the set screws.
6. Next, solder the red power (PWR) and black ground (GND1) wires to the power jack as shown in the following illustration.

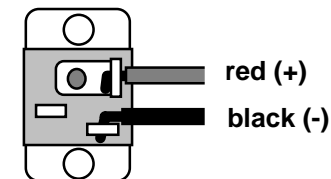

7. Install the face plate into the plastic enclosure. Find the four 3/8" black mounting screws. Insert the screws into the four mounting holes on the face plate and tighten.
8. Finally, place the four rubber feet on the bottom of the enclosure at the corners.

