

IMPORTANT WARRANTY INFORMATION! PLEASE READ

Return Policy on kits When Not Purchased Directly From Vectronics: Before continuing any further with your VEC kit check with your Dealer about their return policy. If your Dealer allows returns, your kit must be returned *before you* begin construction.

Return Policy on kits VVhen Purchased Directly From Vectronics: Your VEC kit may be returned to the factory *in its pre-assembled condition only*. The reason for this stipulation is, once you begin installing and soldering parts, you essentially take over the role of the device's manufacturer. From this point on, neither Vectronics nor its dealers can reasonably be held accountable for the quality or the outcome of your work. Because of this, Vectronics cannot accept return of any kit-in-progress or completed work as a warranty item for any reason whatsoever. If you are a new or inexperienced kit builder, we urge you to read the manual carefully and determine whether or not you're ready to take on the job. If you wish to change your mind and return your kit, you may--but you must do it *before you* begin construction, and within ten (10) working days of the time it arrives.

Vectronics Warrants: Your kit contains each item specified in the parts list.

Missing Parts: If you determine, during your pre-construction inventory, that any part is missing, please contact Vectronics and we'll send the missing item to you free of charge. However, *before you* contact Vectronics, *please look carefully* to confirm you haven't misread the marking on one of the other items provided with the kit. Also, make certain an alternative part hasn't been substituted for the item you're missing. If a specific part is no longer available, or if Engineering has determined that an alternative component is more suitable, Vectronics reserves the right to make substitutions at any time. In most cases, these changes will be clearly noted in an addendum to the manual.

Defective Parts: Today's electronic parts are physically and electrically resilient, and defective components are rare. However, if you discover an item during your pre-construction inventory that's obviously broken or unserviceable, we'll replace it. Just return the part to Vectronics at the address below accompanied with an explanation. Upon receipt, we'll test it. If it's defective and appears unused, we'll ship you a new one right away at no charge.

Missing or Defective Parts After You Begin Assembly: Parts and materials lost or damaged *after construction begins* are not covered under the terms of this warranty. However, most parts supplied with VEC kits are relatively inexpensive and Vectronics can replace them for a reasonable charge. Simply contact the factory with a complete description. We'll process your order quickly and get you back on track.

Factory Repair After You Begin Assembly: *Kits-in progress and completed kits are specifically excluded from coverage by the Vectronics warranty*. However, as a service to customers, technicians are available to evaluate and repair malfunctioning kits for a minimum service fee of \$18.00 (1/2 hour rate) plus \$7.00 shipping and handling (prices subject to change). To qualify for repair service, your kit must be fully completed, unmodified, and the printed circuit board assembled using rosin-core solder. In the event your repair will require more than an hour to fix (or \$36.00, subject to change), our technicians will contact you in advance by telephone before performing the work. Defective units should be shipped prepaid to:

Vectronics
1007 HWY 25 South
Starkville, MS 39759

When shipping, pack your kit well and include the minimum payment plus shipping and handling charges (\$25.00 total). No work can be performed without pre-payment. Also, provide a valid UPS return address and a day time phone number where you may be reached.

| | |
|--|----|
| Introduction..... | 1 |
| Tools and Supplies | 1 |
| Before You Start Building | 2 |
| Soldering Tips: | 2 |
| Desoldering Tips:..... | 2 |
| Work Habits:..... | 3 |
| Sorting and Reading Resistors:..... | 3 |
| Reading Capacitors:..... | 4 |
| Diodes:..... | 4 |
| Transistors:..... | 5 |
| Integrated Circuits: | 5 |
| Parts List..... | 6 |
| Parts Placement Diagram..... | 7 |
| Step-By-Step Assembly..... | 8 |
| PC Board Inspection: | 14 |
| Testing and Alignment | 15 |
| Operating Instructions | 16 |
| Receiver or Scanner Operation | 16 |
| In Case of Difficulty | 17 |
| No Signal Filtering: | 17 |
| Intermittent Filter Operation: | 17 |
| Filter Stops Filtering: | 17 |
| No Speaker Audio:..... | 17 |
| Theory of Operation and Specifications | 18 |
| Operation:..... | 18 |
| Specifications:..... | 18 |
| Enclosure | 18 |
| Schematic..... | 19 |

INTRODUCTION

Thank you for purchasing the VEC-820K CW Filter kit. The VEC-820K consists of a four stage, switch selectable band pass CW filter, using selected components that will make "cleaning up" CW signals effortless and easy. With the VEC-820K you bring up any hard to hear signal out of a "band pile up," for easy listening, or get rid of unwanted, annoying signals. The VEC-820K also features a headphone output that will allow the use of standard monoral headphones. Although physically small in size, the VEC-820K is high on performance and reliability. The VEC-820K is powered from a 9-volt transistor radio battery.

TOOLS AND SUPPLIES

Construction Area: Kit construction requires a clean, smooth, and well-lighted area where you can easily organize and handle small parts without losing them. An inexpensive sheet of white poster board makes an excellent construction surface, while providing protection for the underlying table or desk. Well-diffused overhead lighting is a plus, and a supplemental high-intensity desk lamp will prove especially helpful for close-up work. Safety is an important consideration. Be sure to use a suitable high-temperature stand for your soldering iron, and keep the work area free of combustible clutter.

Universal Kit-building Tools: Although your particular kit may require additional items to complete, virtually all construction projects require a work area outfitted with the following tools and supplies:

- 30-60 watt Soldering Iron
- High-temperature Iron Holder with a Moist Cleaning Sponge
- Rosin-core Solder (thin wire-size preferred)
- Needle Nose Pliers or Surgical Hemostats
- Diagonal Cutters or "Nippy Cutters"
- Wire Strippers
- Solder Sucker, Vacuum Pump, or Desoldering Braid
- Bright Desk Lamp
- Magnifying Glass

BEFORE YOU START BUILDING

Experience shows there are *four common mistakes* builders make. Avoid these, and your kit will probably work on the first try! Here's what they are:

1. Installing the Wrong Part: It always pays to double-check each step. A 1K and a 10K resistor may look *almost* the same, but they may act very differently in an electronic circuit! Same for capacitors--a device marked 102 (or .001 uF) may have very different operating characteristics from one marked 103 (or .01uF)
2. Installing Parts Backwards: Always check the polarity of electrolytic capacitors to make sure the positive (+) lead goes in the (+) hole on the circuit board. Transistors have a flat side or emitter tab to help you identify the correct mounting position. ICs have a notch or dot at one end indicating the correct direction of insertion. Diodes have a banded end indicating correct polarity. Always double-check--especially before applying power to the circuit!
3. Faulty Solder Connections: Inspect for cold-solder joints and solder bridges. Cold solder joints happen when you don't fully heat the connection--or when metallic corrosion and oxide contaminate a component lead or pad. Solder bridges form when a trail of excess solder shorts pads or tracks together (see Solder Tips below).
4. Omitting or Misreading a Part: This is easier to do than you might think! Always double-check to make sure you completed each step in an assembly sequence.



Soldering Tips: *Cleanliness* and good *heat distribution* are the two secrets of professional soldering. Before you install and solder each part, inspect leads or pins for oxidation. If the metal surface is dull, sand with fine emery paper until shiny. Also, clean the oxidation and excess solder from the soldering iron tip to allow maximum heat transfer. Allow the tip of your iron to contact both the lead and pad for about one second (count "one-thousand-one") before feeding solder to the connection. Surfaces must become hot enough for solder to flow smoothly. Feed solder to the opposite side of the lead from your iron tip--solder will wick around the lead toward the tip, wetting all exposed surfaces. Apply solder sparingly, and do not touch solder directly to the hot iron tip to promote rapid melting.

Desoldering Tips: If you make a mistake and need to remove a part, follow these instructions carefully! First, grasp the component with a pair of hemostats or needle-nose pliers. Heat the pad beneath the lead you intend to extract, and pull gently. The lead should come out. Repeat for the other lead.

will enable you to differentiate between the two--chokes are generally larger in diameter and fatter at the ends than resistors. When doing your inventory, separate out any chokes and consult the parts list for specific color-code information.

Reading Capacitors: Unlike resistors, capacitors no longer use a color code for value identification. Instead, the value, or a 3-number code, is printed on the body.

| Value | Code | | | |
|---------|--------|--|--|--|
| 10 pF | = 100 | | | |
| 100 pF | = 101 | | | |
| 1000 pF | = 102 | | | |
| .001 uF | = 102* | | | |
| .01 uF | = 103 | | | |
| .1 uF | = 104 | | | |

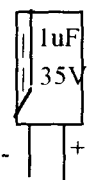
| Multilayer (270 pF) | Ceramic Discs (.001 uF) (.1 uF) | | Electrolytic 1 uF |
|---|---|---|---|
|  |  |  |  |

As with resistors, it's helpful to sort capacitors by type, and then to arrange them in ascending order of value. Small-value capacitors are characterized in pF (or pico-Farads), while larger values are labeled in uF (or micro-Farads). The transition from pF to uF occurs at 1000 pF (or .001 uF)*. Today, most monolithic and disc-ceramic capacitors are marked with a three-number code. The first two digits indicate a numerical value, while the last digit indicates a multiplier (same as resistors).

Electrolytic capacitors are always marked in uF. Electrolytics are polarized devices and must be oriented correctly during installation. If you become confused by markings on the case, remember the uncut negative lead is slightly shorter than the positive lead.

Diodes: Diodes are also polarized devices that must be installed correctly. Always look for the banded or cathode end when installing, and follow instructions carefully.

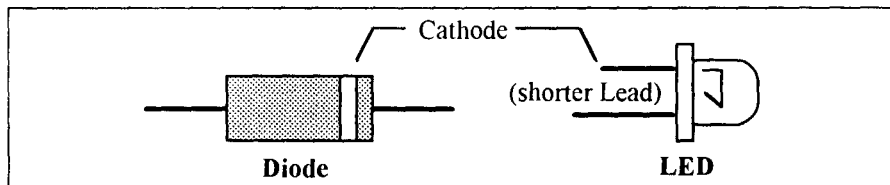

Transistors: If transistors are installed incorrectly, damage may result when power is applied. Transistors in metal cases have a small tab near the emitter lead to identify correct positioning. Semiconductors housed in small plastic cases (TO-92) have an easily-identified flat side to identify mounting

orientation. Many specialized diodes and low-current voltage regulators also use this type packaging. Larger plastic transistors and voltage regulators use a case backed with a prominent metal tab to dissipate heat (T-220). Here orientation is indicated by the positioning of the cooling tab.

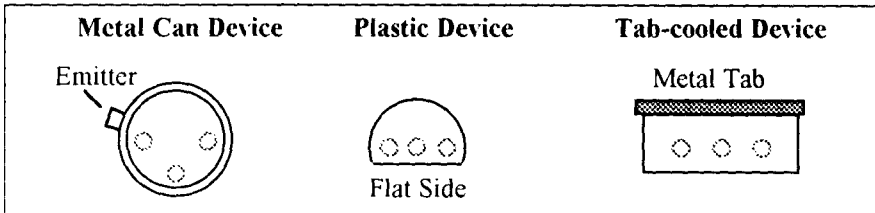

Integrated Circuits: Proper IC positioning is indicated by a dot or square marking located on one end of the device. A corresponding mark will be silk-screened on the PC board and printed on the kit's parts-placement diagram. To identify specific IC pin numbers for testing purposes, see the diagram below. Pin numbers always start at the keyed end of the case and progress counter-clockwise around the device, as shown:

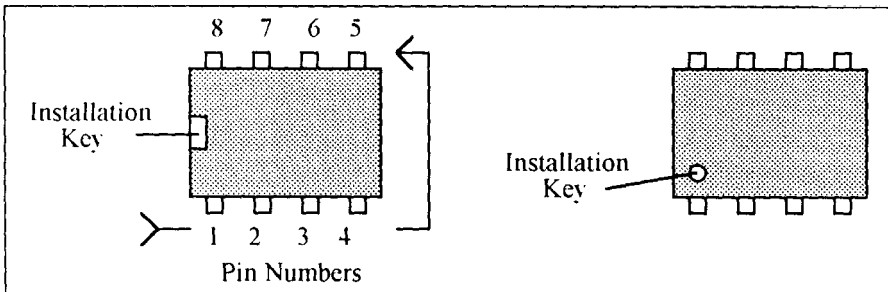

PARTS

Your kit should contain all of the parts listed below. Please go through the parts bag to identify and inventory each item on the checklist before you start building. If any parts are missing or damaged, refer to the warranty section of this manual for replacement instructions. If you can't positively identify an unfamiliar item in the bag on the basis of the information given, set it aside until all other items are checked off. You may then be able to identify it by process of elimination. Finally, your kit will go together more smoothly if parts are organized by type and arranged by value ahead of time. Use this inventory as an opportunity to sort and arrange parts so you can identify and find them quickly.

| <u>Qty</u> | <u>Part Description</u> | <u>Designation</u> |
|------------|---|------------------------------|
| 6 | 24.3K* ohm resistor (red-yellow-orange-brown) | R9,R10,R12 1,R12. R13,R14 |
| -4 | 681 K* resistor (blue-gray-brown-orange) | R5, R6. R7, R8 |
| 4 | 1.82M* ohm resistor (brown-gray-red-yellow) | R1, R2. R3, R-4 |
| 8 | 1000 pF poly capacitor (1000J) | C1,C2,C3,C4,C5,C6 C7,C8 |
| 1 | 01 uF disc ceramic capacitor (103Z) | C9 |
| 2 | 10 uF electrolytic capacitor (10uf) | C10, c1 I |
| 2 | 1-4 pin IC sockets | For U1. U2 |
| 2 | LM747 Op Amp IC | U1 . U2 |
| 1 | 4P4T Slide Switch with screws | SW1 |
| 6 | 6" Insulated wires | Circuit wiring |
| 1 | 9-volt batter, snap | GND. VCC |
| 1 | PC board VEC-820K | |
| 1 | Owner's Manual | |

" These parts have a 1% tolerance, The fourth color band on these components will BROWN, specifying a 1% tolerance. b

PARTS PLACEMENT DIAGRAM

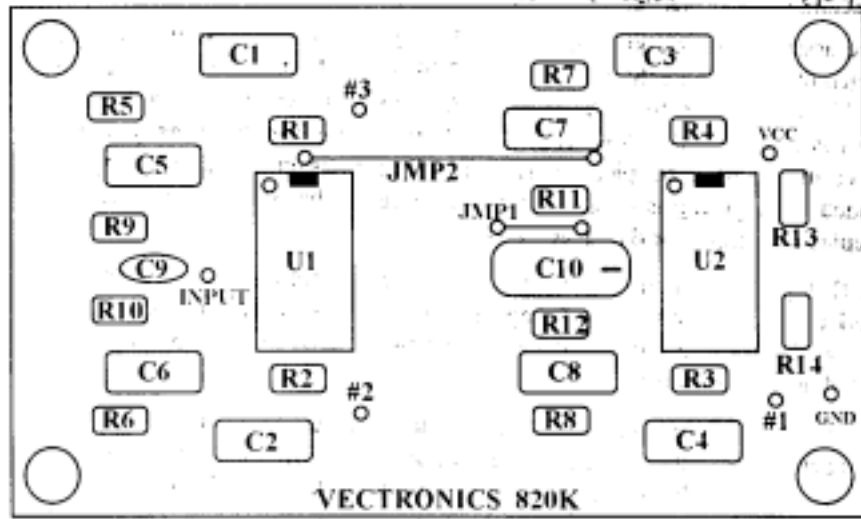

Figure 1

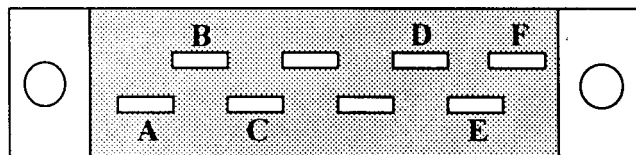

Figure 2

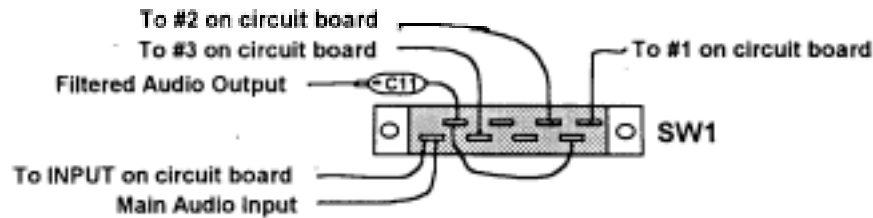

Figure 3

STEP-BY-STEP ASSEMBLY

Before assembling your kit, please take time to read and understand the VEC kit warranty printed on the inside cover of this manual. Also, read through the assembly instructions to make sure the kit does not exceed your skill level. *Once you begin construction, your kit will be non-returnable.* Finally, if you haven't already done so, please verify that all parts listed in the inventory are included.

If anything is missing or broken, refer to the warranty instructions for replacing missing or damaged parts.

Note that part designators, such as R1, C3, etc., appear on a silk-screened legend on the component-mounting side of the printed circuit board. This corresponds with the parts placement page in the manual. All parts will be inserted on the silk-screen side of the board.

If you have last-minute questions about what you need to build your kit, please refer back to the section titled "Tools and Supplies". If you're ready to begin now, here we go! The directions use two sets of check boxes. Check one when a step is complete and use the other for double-checking your work before operation.

Important Note: Capacitors C1-C8 are made of a polystyrene type material. Avoid overheating these components when soldering to prevent melting the capacitor body.

1. Locate capacitor C 1 (1000pF). This is a polystyrene capacitor and will be marked with a "1000P" on the body (actual value in pF).
2. Mount C 1 and solder both leads in place, making sure the capacitor remains seated, Remove excess leads on the bottom side of the board with diagonal cutters.
3. Locate capacitor C2 (1000 pF). This is another polystyrene capacitor, and it will be marked with a "1000J" (actual value in pF). Carefully install C2 in the same manner as C1, and solder in place.
4. Locate capacitor C3 (1000pF). This is another polystyrene capacitor and it will also be marked "1000T" (actual value in pF). Carefully install C3 in the same manner as C2, and solder in place.
5. Locate capacitor C4 (1000pF). This is another polystyrene capacitor and will be marked "1000J" (actual value in pF). Carefully install C4 in the same manner as C3, and solder in place.
6. Locate capacitor C5 (1000pF). This is yet another polystyrene capacitor and will be marked "1000J" (actual value in pF). Carefully install C5 in the same manner as C4, and solder in place.

7. Locate capacitor C6 (1000pF). This is yet another polystyrene capacitor and will be marked "1000J" (actual value in pF). Carefully install C6 in the same manner as C5, and solder in place.

8. Locate capacitor C7 (1000pF). This is yet another polystyrene capacitor and will be marked "1000J" (actual value in pF). Carefully install C7 in the same manner as C6, and solder in place.

9. Locate capacitor C8 (1000pF). This is the final polystyrene capacitor and will be marked "1000J" (actual value in pF). Carefully install C8 in the same manner as C7, and solder in place.

10. Locate capacitor C9 (.01uF). This is a disc ceramic type capacitor and will be marked "103" or "103Z" (actual value in uF). Carefully install C9, ensuring not to chip the ceramic material. Once installed, then solder in place.

11. Locate resistor R1. This is a 1.82M resistor (brown-gray-red-yellow brown).

Carefully bend the leads close to the resistor body to form right-angles (see following diagram).

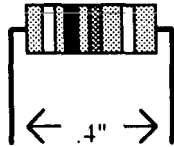

12. Insert R1 into its mounting holes so the resistor body rests against the board. Solder in place and trim the leads.

13. Locate resistor R2. This is a 1.82M resistor (brown-gray-red yellow-brown). Carefully bend the leads close to the resistor body as in Step #11.

14. Insert R2 into its mounting holes so the resistor body rests against the board. Solder in place and trim the leads.

15. Locate resistor R3. This is a 1.82M resistor (brown-gray-red-yellow brown). Carefully bend the leads close to the resistor body as in Step #11

16. Insert R3 into its mounting holes so the resistor body rests against the board. Solder in place and trim the leads.

17. Locate resistor R4. This is a 1.82M resistor (brown-gray-red-Nellmc brotk W). Carefully bend the leads close to the resistor body as in Step #11.
18. Insert R4 into its mounting holes so the resistor body rests against the board. Solder in place and trim the leads.
19. Locate resistor R5. This is a 681K resistor (blue-gray-brown-orange brown). Carefully bend the leads close to the resistor body as in Step #11.
20. Insert R5 into its mounting holes so the resistor body rests against the board. Solder in place and trim the leads.
21. Locate resistor R6. This is a 681K resistor, (blue-gray-brown-orange brown). Carefully bend the leads close to the resistor [body](#) as in Step #11.
22. Insert R6 into its mounting holes so the resistor body rests against the board. Solder in place and trim the leads.
23. Locate resistor R7. This is a 681K resistor (blue-gray-brown-orange brown). Carefully bend the leads close to the resistor body as in Step #11.
24. Insert R7 into its mounting holes so the resistor body rests against the board. Solder in place and trim the leads.
25. Locate resistor R8. This is a 681K resistor (blue-gray-brown-orange-brown). Carefully bend the leads close to the resistor body as in Step #11.
26. Insert R8 into its mounting holes so the resistor body rests against the board. Solder in place and trim the leads.
27. Locate resistor R9. This is a 24.3K resistor (red-yellow-orange-red-brown). Carefully bend the leads close to the resistor body as in Step #11.
28. Insert R9 into its mounting holes so the resistor body rests against the board. Solder in place and trim the leads.
29. Locate resistor R10. This is a 24.3K resistor (red-yellow-orange-red-brown). Carefully bend the leads close to the resistor body as in Step #11.

30. Insert RIO into its mounting holes so the resistor body rests against the board. Solder in place and trim the leads.

31. Locate resistor R11. This is 24.3K resistor (red-yellow-orange-red-brown). Carefully bend the leads close to the resistor body as in Step #11.

32. Insert RI 1 into its mounting holes so the resistor body rests against the board. Solder in place and trim the leads.

33. Locate resistor R12. This is 24.3K resistor (red -yellow-orange-red-brown). Carefully bend the leads close to the resistor body as in Step #11.

34. Insert R12 into its mounting holes so the resistor bod_N rests against the board. Solder in place and trim the leads.

35. Locate resistor R13. This is 24.3K resistor (red-yellow-orange-red-brown). Carefully bend the leads close to the resistor body as in Step #11.

36. Insert R13 into its mounting holes so the resistor body rests against the board. Solder in place and trim the leads.

37. Locate resistor R14 This is 24.3K resistor (red-yellow-orange-red-brown). Carefully bend the leads close to the resistor body as in Step #11.

38. Insert R14 into its mounting holes so the resistor body rests against the board. Solder in place and trim the leads. Save the excess trimmed pieces of resistor lead. You will need it later.

39. Locate a G" length piece of insulated wire. and cut piece 1 1/4" long off of it

40. Using the wire strippers, remove 1/4" of insulation from each end of the 1 1/4" wire.

41. Insert the bare ends of the 1 1/4" wire into the holes on the circuit board located at JMP2. Please refer to the section titled "Parts Placement". Figure 1 for the location of JNIP2.

42. Solder the 1 1/4" wire in place at JNIP2 and trim the excess wire.

43. Locate the pieces of excess resistor lead you saved back in step #38.

44. Install the excess lead in the holes located at JNIP I on the circuit board. Solder in place and trim the excess lead.

45. Locate capacitor C10 (10uF). This is an electrolytic type capacitor and will be marked "10uF" (actual value in uF). Carefully install C10: be sure to orient the negative end of the capacitor properly. Please refer to the section titled, "Parts Placement", Figure I for correct orientation of C10. Once installed, then solder in place and trim excess lead.
46. Take the remaining 6" lengths of insulated wire and cut them in half. You should have (10) 3" pieces of insulated wire.
47. Using the wire strippers, remove a 1/8" piece of insulation from each of the 10 pieces of insulated wire.
48. Take a 3" piece of insulated wire and insert one end into the hole silk-screened INPUT on the circuit board. Solder in place and trim the excess lead.
49. Take one 3" piece of insulated wire and insert one end into the hole silk-screened #1 on the circuit board. Solder in place and trim the excess lead.
50. Take one 3" piece of insulated wire and insert one end into the hole silk-screened #2 on the circuit board. Solder in place and trim the excess lead.
51. Take one 3" piece of insulated wire and insert one end into the hole silk-screened #3 on the circuit board. Solder in place and trim the excess lead.
52. Locate the battery snap. Insert the RED lead into the hole silk-screened VCC on the circuit board. Solder in place and trim the excess lead.
53. Insert the BLACK lead of the battery into the hole silk-screened GND on the circuit board. Solder in place and trim the excess lead.
54. Locate the 4P-1T slide switch (S W)
55. Inspect the slide switch for tarnished contacts. Remove any tarnish with very fine sandpaper so the contacts are nice and shiny. This will provide a good soldering surface.

Note: Please refer to the section titled, "Parts Placement" Figure 2 for Steps 56 through 66.

56. Connect one 3" piece of insulated wire to Point A on SW1. Do not solder yet.

57. Connect the other end of the insulated wire located at the INPUT location on the circuit board to **Point A** on SW 1. Solder in place and trim the excess lead from the switch contact.
58. Locate capacitor C 11 (1 Ouf . This is an electrolytic type capacitor and will be marked "IOuF" with an arrow pointing to the negative end.
59. Trim the positive lead of C 11 so about only 3/8" of the lead
60. Connect the positive lead of C 11 at **Point B** on SW 1. Do not solder this switch contact yet.
61. Connect the other end of the insulated wire located at #3 on the circuit board at **Point C** on SW 1. Solder in place and trim the excess lead from the switch contact.
62. Connect the other end of the insulated wire located at #2 on the circuit board at **Point D** on SW 1. Solder in place and trim the excess lead from the switch contact.
63. Connect the other end of the insulated wire located at #1 on the circuit board at **Point F** on SW 1. Solder in place and trim the excess lead from the switch contact.
64. Cut a 1 1/4" piece of wire from one of the remaining 3"
65. Using the wire strippers, remove a 1/4" piece of the insulation from each end of the 1 1/4" wire.
66. Connect the 1/4" piece of wire between **Points B and E** on SW 1. Solder in place and trim the excess lead from the switch contact.
67. Locate (1) 14 pin IC socket.
68. Install the IC socket at the U1 location on the circuit board. Be careful to orient the socket correctly according to the "Parts Placement" section Figure 1.
69. Carefully bend over the four corner pins of the socket against the solder pads on the solder side of the board. Solder in place.
70. Locate the remaining 14 pin IC socket.
71. Install the IC socket at the U2 location on the circuit board. Be careful to orient the socket correctly according to the "Parts Placement" section Figure 1.

- □ 72. Carefully bend over the four corner pins of the socket against the solder pads on the solder side of the board. Solder in place.
- □ 73. Locate both LM747 op amp integrated circuits. Insert them into IC sockets for U 1 and U2. Please refer to the "Parts Placement" section. Figure 1 for proper orientation. Be sure not to bend any of the pins underneath the IC body, and that all pins are inserted into the socket.

At this point, your kit is finished and it's time to take a well-earned break! When you come [back](#), be sure to give your work a close "quality control" inspection.

PC Board Inspection:

Before applying power to your kit, give it a thorough QC (quality control) inspection. This will help you find inadvertent assembly errors that might prevent the filter from working or cause damage to sensitive parts. Follow this procedure:

Compare parts locations against the parts-placement diagram. Was each part installed where it is supposed to be? Was the correct value used? Start at one side of the board and work your way across in an organized pattern.

- I] Inspect the solder side of the board for cold-solder joints and solder bridges between tracks or pads. Use a magnifying glass to obtain a clear view of the track area. If you suspect a solder bridge, hold the board in front of a bright light for a better view. All joints should be smooth and shiny, indicating good solder wetting and flow. Resolder any beaded or dull appearing connections.

If you find a construction error and need to remove a part or two, it will be easier if you have the right tools. One very convenient item for freeing soldered-in parts is a "solder sucker". This consists of a suction bulb or a spring loaded vacuum pump that draws molten solder away from the pad and lead. Alternatively, you may use a special copper braid called "solder wick" (solder suckers and solder wick are both available at your local Radio Shack or electronics supply house). If you suspect you've damaged a component during removal, better to replace it than risk reusing it!

Finally, rosin flux can absorb moisture, which may cause a problem for some electronic equipment. To remove flux, use isopropyl alcohol (or 95% grain alcohol) and an old toothbrush. Apply a generous amount of alcohol with the toothbrush and scrub gently. Once the flux has fully dissolved, blot the bottom of the board dry with an untreated tissue. Give it a final alcohol wash, and allow to dry thoroughly.

CAUTION: ALCOHOL IS HIGHLY FLAMMABLE AND MUST BE USED WITH ADEQUATE VENTILATION! USE SAFETY GOGGLES, AND AVOID PROLONGED SKIN CONTACT. IT'S ALSO BEST TO DO THIS OUTDOORS.

Now that assembly and inspection is completed, you're ready to begin the testing and alignment phase of construction.

The best way to test the VEC-820K is with a calibrated audio signal generator and oscilloscope. However, VEC-820K does not require any alignment. If all components are installed correctly and in the proper places, the center frequency of the filter will be between 750-800 hertz. The filter has three switch selectable selectivity cutoff points, 80, 110, and 180 hertz. The switch positions on SW1 from left to right are BYPASS, 180, 110, and 80. The 80 hertz cutoff is the fourth switch position from the left and is the narrowest filter cutoff, while the 180 hertz cutoff is the second position from the left and is the widest filter cutoff.

Probably the best method of seeing if the VEC-820K is working, or not, is to listen to some "on the air" CW signals. Then using SW1, select the filter cutoff position that best cleans up the signal being received.

If you are trying to pick one signal out of a very tight band pile up, then try using the 80 hertz cutoff. The 80 hertz cutoff provides the highest selectivity and will greatly help you in "pulling out" those hard to get signals.

If the CW signal you are receiving is noisy with some static, then try either the 110 or 180 filter cutoffs. However, in these positions the filter will let slightly more noise through, but in some cases this may be desirable. The best way to see which position works the best is to try it. This way you can really hear what the filter is doing for the received signal, and which switch position works the best in different band conditions.

You may use the VEC-820K with any communications receiver or scanner with a BFO (Beat Frequency Oscillator). You can also use the VEC-820K with a ham-radio transceiver in either LSB or CW mode. The VEC-820K requires a 9-volt battery power source.

There are a few items that you will need to operate the VEC-820K. We have provided a list of these items below for your convenience.

Communications Receiver, scanner, or Ham Radio transceiver Nyith proper cables.

0 9-Volt transistor radio batten

External speaker with clip

Receiver or Scanner

As mentioned above, you can use the VEC-820K with a communications receiver or scanner. The receiver or scanner must be equipped with a BFO, or Beat Frequency Oscillator. The BFO will allow you to fine tune the received CW signal to the VEC-820 center frequency. The center frequency of the filter being 750-800 hertz.

The filter requires audio from the external speaker or headphones output of the receiver or scanner. This positive side of the audio signal is applied to the insulated Nyire connected to **Point A** on SW 1. Apply the negative side of the audio to the negative side of the battery snap. Please refer to the "Parts Placement" section, Figure 2 for the location of **Point A** on SW 1.

Nest, connect the POSITIVE lead of the external speaker to the NEGATIVE end of C11. Please refer to the "Parts Placement" section Figure 3 for the location of C 11. Connect the NEGATIVE lead of the external speaker to the point labeled GND on the circuit board. Again please refer to the "Parts Placement" section Figure 1 for the location of the point labeled GND on the circuit board.

Nest, turn the receiver volume all the way down, then clip the 9-volt battery to battery snap. Set SW1 to the far left position. Now turn the receiver up slightly so you can hear the received signals on the external speaker. The signal you are listening to is the "raw" or "unfiltered" signal. Using the tuning knob on the radio find a CW signal. A good place to find CW signals is in the Amateur Radio bands. Once you find a CW signal switch SW I to the 110 filter cutoff. The 110 position is the third from the left. When you switch to the 110 cutoff, you will notice that the signal sounds cleaner than before. You can now fine tune the radio tuning knob for the best received signal. If using a

communications receiver or scanner with a BFO control. use this control to fine tune the received CW signal. If the receiver or scanner you are using does not have a BFO control, it will be very difficult trying to tune the signal in properly.

If the signal you are trying to receive is in a "pile up", then try the 80 hertz filter cutoff. Then fine tune the receiver to "pull out" the desired signal.

Operation with an Amateur Radio transceiver is basically the same, but you would use either LSB (Lower Side Band) or CW mode. All other connections are the same.

IN CASE OF DIFFICULTY

No Signal Filtering:

A newly constricted filter that fails to work upon initial power up. generally requires a very close and careful inspection of all work. Please go back through all steps of assembly and inspection. referring to the "Parts Placement" Figures 1, 2, and 3. Most of the time there will be a part that is not installed or not installed properly. a wrong value part in place of another. or a broken part. A close inspection at this point will reveal some accidental mistake.

Intermittent Filter Operation

A filter that operates intermittently may have poor solder connections. a problem with broken wires, or low voltage power source. Self-oscillation. may be caused by a defective U1 or U2. Also check for dirty or intermittent switch operation.

Filter Stops Filtering:

A working filter that fails "in-service" generally indicates a failure of in one or both U1 or U2. If you suspect a bad U1 or U2. then **do not touch** the part with your fingers. If the part is bad, it could be HOT and could cause a serious burn. Other things that should be checked is the supply voltage of the 9-volt battery. broken wires to and from the circuit board and switch.

No Speaker Audio:

No speaker audio can be a symptom of a bad SW1, a broken wire or a bad C11. Check the voltage from the 9-volt battery. A broken wire at the audio input to the filter can also attribute to no speaker audio.

If technical assistance or factory repair is desired, please refer to the warranty instructions on the inside front cover

THEORY OF OPERATION AND SPECIFICATIONS

Circuit Description:

The VEC-820K uses two UA747 operational amplifier integrated circuits to form four low Q cascaded stages with no insertion loss. This results in a very narrow bandwidth and extremely high skirt rejection with minimum audible ringing, making good signal copying possible. The center frequency is between 750-800 hertz. The filter is able to drive an 8 ohm speaker or

Specifications:

Bandwidth:.....80 Hz, 110 Hz, 180 Hz (switch)

Skirt Rejection:..... At least 60dB down 1 octave from center frequency for 80 Hz. bandwidth

Center Frequency:..... 750-800 Hz

Insertion Loss:..... None

Power Required:..... 9-volts DC: 9-volt battery

Dimensions:..... 2 inch x 3 inch printed circuit board.

ENCLOSURE

Vectronics has designed a matching enclosure just for your VEC-820K Super
CIF Audio Filter Kit. The matching enclosure is an all metal box which
includes knobs, hardware, decals, and rubber feet. The Vectronics model
number for the matching enclosure is VFC-820KC.

SCHEMATIC

