

Thanks for buying the  WOUXUN KG-816 series transceiver. This transceiver offers latest in design, multi-functionality, stable behaviour and easy operation. We believe you will be pleased with the high quality and dependable features for all your communication needs.

Warning 

» Please turn off your transceiver while taking on fuel, or while parked at a gasonline service station.

Please take time to understand this radio. After reading the manual you will fully benefit from all intelligent functions of the KG-816.

Wouxun transceiver are provided with excellent design and advanced technology. Please follow the next steps so you can enjoy the radio and avoid problems.

1. Please keep transceiver and their parts away from children.
2. Do not take it apart, or have it repaired by a nonprofessional.
3. Only use the supplied charger with radio and batterypack.
4. Only use the supplied antenna for maximum reach.
5. Do not expose the transceiver to long periods in direct sunlight nor place close to heating appliances.
6. Keep transceiver away from excessive dust, humidity.
7. Do not use aggressive material to clean the radio, but use a mild brush or cloth.
8. Do not transmit without the supplied antenna.
9. If an abnormal odor or smoke is detected coming from the transceiver, switch the power off immediately and remove the optional batterypack from the transceiver. Contact your **Wouxun** dealer.

NOTE 

- » All advice mentioned above are the same for all **Wouxun** transceiver. If the transceiver do not work, please contact your nearest **Wouxun** dealer.
- » **Wouxun** does not guarantee the safety and operation of any **Wouxun** transceiver when using accessories which are not supplied by **Wouxun**.

Contents

Unpacking and checking of your equipment	1
<i>Supplied accessories</i>	1
Description of functions	2-3
Getting started	4-8
<i>LCD display</i>	4
<i>Description of transceiver</i>	5
Shortcut operation sheet	9-14
How to operate	15-59
<i>Look menu functions</i>	15
<i>Setting frequencystep (STEP) ---- MENU 1</i>	15
<i>Setting batterypack savemode (SAVE) --- MENU 2</i>	16
<i>Setting squelch level (SQL-LE) ---- MENU 3</i>	16
<i>Setting transmission (TXSET) ---- MENU 4</i>	17
<i>CTCSS / DCS Frequencyscan (SCN CD) --- MENU 5</i>	20
<i>Setting voice prompt (SETVOC) ---- MENU 6</i>	21
<i>Setting VOX (VOX) ---- MENU 7</i>	23
<i>Setting receiving CTCSS / DCS (RX-CDC) ---- MENU 8</i>	24
<i>Setting transmitting CTCSS / DCS (TX-CDC) ---- MENU 9</i>	25

Contents

<i>Definition of sidekey (PFKEY) ---- MENU 10</i>	27
<i>Setting keypad locked (AUTOLK) ---- MENU 11</i>	31
<i>Setting auto-backlight (ABR) ---- MENU 12</i>	32
<i>Setting offset (FRQOFF) ---- MENU 13</i>	33
<i>Setting scanmode (SC-REV) ---- MENU 14</i>	35
<i>Setting power on message (PONMSG) ---- MENU 15</i>	36
<i>Setting stopwatch timer (SECOND) ---- MENU 16</i>	37
<i>Setting working mode (CH-MDF) ---- MENU 17</i>	37
<i>Edit channel name (CHNAME) ---- MENU 18</i>	39
<i>Setting memory channel (MEM-CH) ---- MENU 19</i>	41
<i>Deleting channel (DE-CH) ---- MENU 20</i>	42
<i>ANI ID CODE edit (IDEDIT) ---- MENU 21</i>	43
<i>Setting DTMF (SETDTF) ---- MENU 22</i>	43
<i>All calls, group calls and selective calls</i>	47
<i>Inspection, monitor, stun, kill and emergency</i>	50
<i>Setting reset (RESET) ---- MENU 23</i>	54
<i>Setting priority scan function</i>	55
<i>Setting reverse frequency function</i>	55

<i>Low voltage battery voice prompt</i>	56
<i>Adding channelscan</i>	56
<i>Wireclone function</i>	56
<i>Setting transmit overtime prompt</i>	57
<i>Programming repeater function</i>	57
<i>How to use your intelligentcharger</i>	58
Trouble shooting	60-61
Technology parameter	62-64
<i>Appendix 1 (CTCSS)</i>	62
<i>Appendix 2 (DCS)</i>	63
Technology specification	65
Optional accessories	66
Announce	67

Unpacking and checking of your equipment

Carefully unpack the transceiver. We recommend that you identify the items in the following table before discarding the packing material. If any items are missing or have been damaged during shipment, please notify your **Wouxun** dealer.

Supplied accessories

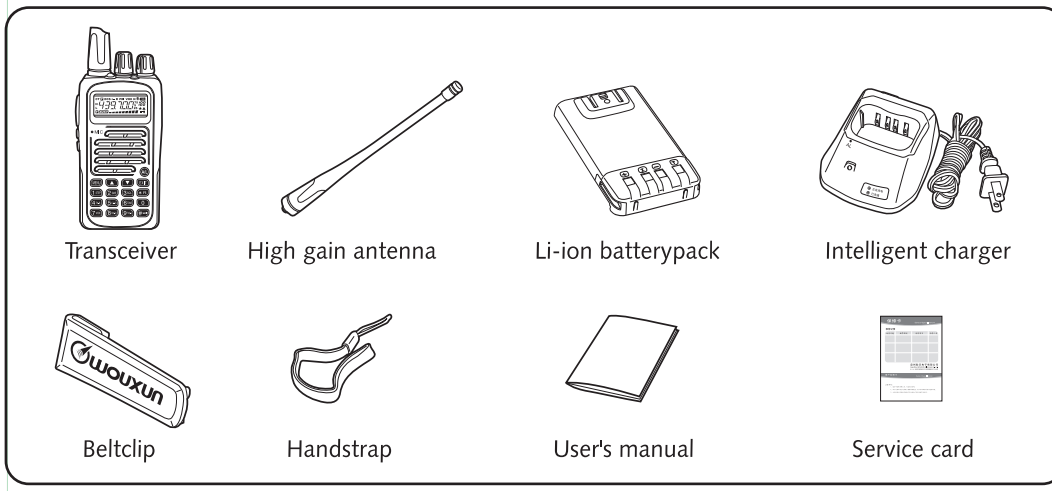

01

Description of functions

Wouxun
Professional FM Transceiver

1. VHF: 136-174MHz/245-250MHz/216-280MHz/225-226MHz
UHF: 400-470MHz/350-390MHz/400-480MHz/420-520MHz/403-469.9875MHz
2. Output power: VHF: 5W/1W UHF: 4W/1W
3. 199 memory channels
4. DTMF encoding and decoding
5. ANI (caller ID)
6. VOX
7. All calls, group calls and selective calls function
8. Calling ring function
9. Stopwatch function
10. 105 groups DCS/50 groups CTCSS
11. Voiceguide (English/Chinese)
12. Wide/Narrow bandwidth selection (25KHz/12.5KHz)
13. Auto backlight
14. Channel number, channel frequency, channel name multi-display method
15. Reverse frequency function
16. Distant urgency alarm, SOS function
17. Multi scan function
18. Priority scan function, Inspection, monitor, stun, kill and emergency

02

Description of functions

19. Digital FM radio
20. Frequency step selection (5/6.25/10/12.5/25/50/100KHz)
21. High/Low power selectable (UHF:4W/1W VHF:5W/1W)
22. High capacity Li-ion battery pack
23. Intelligent charger
24. TX/RX split selection (0.05-69.950MHz)
25. Setting frequency shift direction
26. Busy channel lockout
27. Multi display modes when power on (full screen / Batt-V / others)
28. Low voltage battery pack voice prompt
29. Transmit overtime prompt
30. Keyboard lock (auto / manual)
31. Adding channel scan function
32. High/Low power changeable when on transmitting
33. Programmable by computer
34. Wireclone function
35. Menu / Channel reset

03

Getting started

wouxun
Professional FM Transceiver

LCD display

On the display you will see various indicators that show what function you have selected. Sometimes you may not recall what those indicators mean, or how to select them, in such a case, you can refer to the table below.

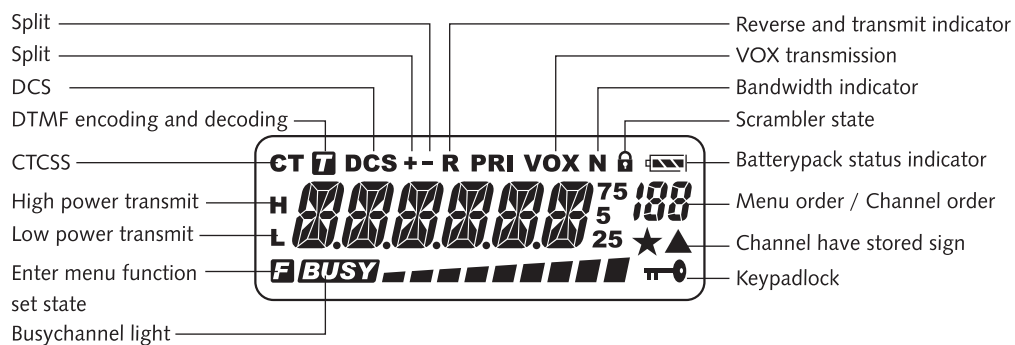

Note:

- | | |
|---------------------------------------|-----------------------------------|
| Batterypack capacity indicator (full) | Batterypack capacity is exhausted |
| Batterypack capacity spare indicator | Receive signal meter |

04

Getting started

Description of transceiver

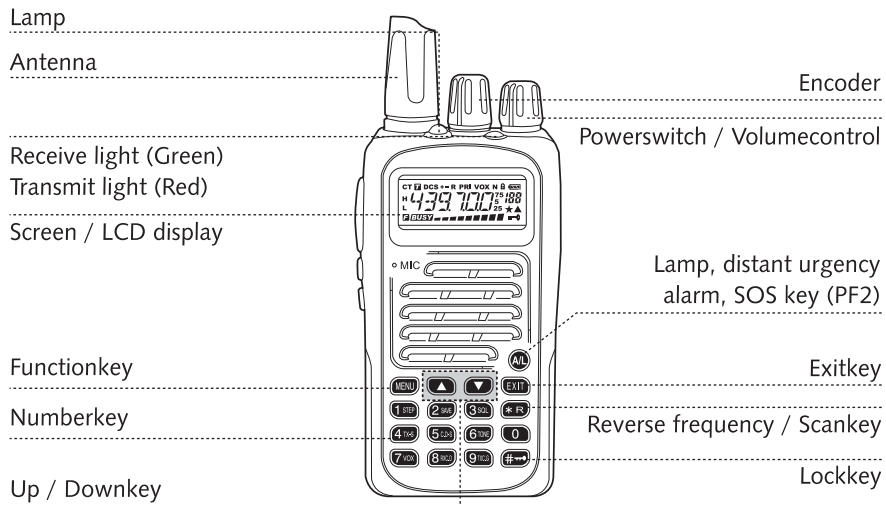

05

Wouxun
Professional FM Transceiver

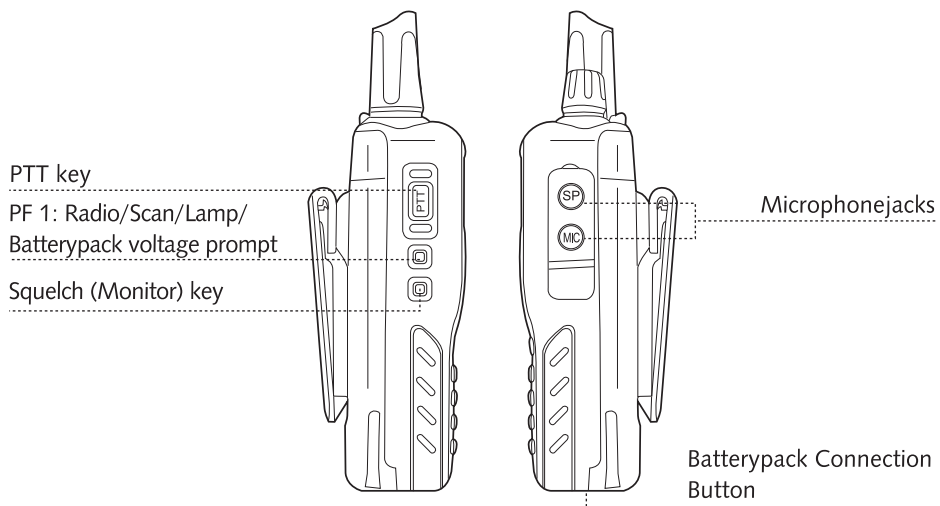

06

Getting started

■ Install/Remove Battery pack

The battery pack was not fully charged before leaving factory. Please charge it before use.

NOTE

- » Don't shortcircuit of the terminals or put the battery pack into fire.
- » Don't try to remove the case from the battery pack.

1. Please aim the battery pack at the back of the transceiver, and then push up the battery pack and the transceiver till the connection button on the bottom of the transceiver locked. (PIC1)
2. If you want to remove the battery pack, press the connection button on the bottom of the transceiver, and push the battery pack up the transceiver. (PIC2)

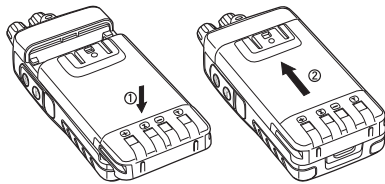



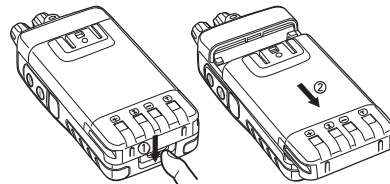

PIC1



PIC2



07

■ Speed search

When setting each function or parameter, press the  or  key one time can start searching the function or parameter. Press  or  can speed search.

■ DTMF encoding

This transceiver has DTMF encoding. By pressing the right number key on transmitting you can choose the right DTMF tone which you want to TX. Number key and the corresponding DTMF encoding are as follows:

MENU			EXIT	
1 STEP	2 SWE	3 SQL	* R	A
4 TWS	5 CDS	6 TONE	0	B
7 VOX	8 RICD	9 TICS	#	C
				D

→

1	2	3	*
4	5	6	0
7	8	9	#

■ Switch working mode

Shortcut key on switching working mode:  + . Every operation can switch frequency mode and channel mode.

■ Transmit 1750Hz tone

Press PTT to transmit, and press PF1 key at the same time, which will transmit 1750Hz tone.

08

Shortcut operation sheet

Function order	Function name	Enter function set	Screen display	Select parameter	Selectable parameter-explanation	Confirm	Back	See page
1 Setting frequency step	MENU → 1 STEP	"STEP"	MENU →	Press ▲ or ▼ key Select step	7 kinds of channel step 5K/6.25K/10K/12.5K/25K/50K/100K	MENU →	EXIT	P14
2 Setting battery pack savemode	MENU → 2 SAVE	"SAVE"	MENU →	Press ▲ or ▼ key Select step	ON: Turn on save function OFF: Turn off save function	MENU →	EXIT	P15
3 Setting squelch level	MENU → 3 SOL	"SOL --LE"	MENU →	Press ▲ or ▼ key Select step	Squelch level from 0 to 9	MENU →	EXIT	P15
4 Setting transmission	MENU → 4 TX-S	"TXSET"	MENU →	Press ▲ or ▼ key Select step		MENU →		
			MENU →	Press ▲ or ▼ key Select step	H: High power (VHF 5W/ UHF 4W). L: Low power (1W)	MENU →	EXIT	P16
			MENU →	Press ▲ or ▼ key Select step	Transmit overtime alarm has levels from 1 to 10 and 1 second each level. OFF: Turn off transmit overtime alarm	MENU →	EXIT	P17
			MENU →	Press ▲ or ▼ key Select step	TOT has 40 levels in steps of 15 seconds. OFF: Turn off TOT.	MENU →	EXIT	P17
			MENU →	Press ▲ or ▼ key Select step	ON: Turn on busy channel lock out OFF: Turn off busy channel lock out	MENU →	EXIT	P18
			MENU →	Press ▲ or ▼ key Select step	WIDE: 25KHz. NARR: 12.5KHz.	MENU →	EXIT	P18

09

Function order	Function name	Enter function set	Screen display	Select parameter	Selectable parameter-explanation	Confirm	Back	See page
5 CTCSS/DCS frequency scan	MENU → 5 C.D.-S	"SCAN"	MENU →	Press ▲ or ▼ key Select step	CTCSS: CTCSS scan DCS: DCS scan	MENU →	EXIT	P19
6 Setting voiceguide	MENU → 6 TONE	"SETVOC"	MENU →	Press ▲ or ▼ key Select step		MENU →		
			MENU →	Press ▲ or ▼ key Select step	CHINES: Chinese ENGLISH: English OFF: Turn off voiceguide	MENU →	EXIT	P20
			MENU →	Press ▲ or ▼ key Select step	OFF: Turn off all, not transmit BOT: Press PTT to transmit EOT: Releasing PTT to transmit BOTH: Both pressing and releasing PTT to transmit	MENU →	EXIT	P21
			MENU →	Press ▲ or ▼ key Select step	ON: Turn on beeprompt OFF: Turn off beeprompt	MENU →	EXIT	P21
7 Setting VOX	MENU → 7 VOX	"VOX"	MENU →	Press ▲ or ▼ key Select step	VOX has levels from 1 to 10 OFF: Turn off VOX transmission	MENU →	EXIT	P22
8 Setting receiving CTCSS/DCS	MENU → 8 RX-D.C	"RX-D.C"	MENU →	Press ▲ or ▼ key Select step		MENU →		
			MENU →	Press ▲ or ▼ key Select step	105 groups DCS (D023N-D754N) OFF: Turn off DCS	MENU →	EXIT	P23
			MENU →	Press ▲ or ▼ key Select step	50 groups CTCSS (67 -254.1Hz) OFF: Turn off CTCSS	MENU →	EXIT	P24

10

Shortcut operation sheet

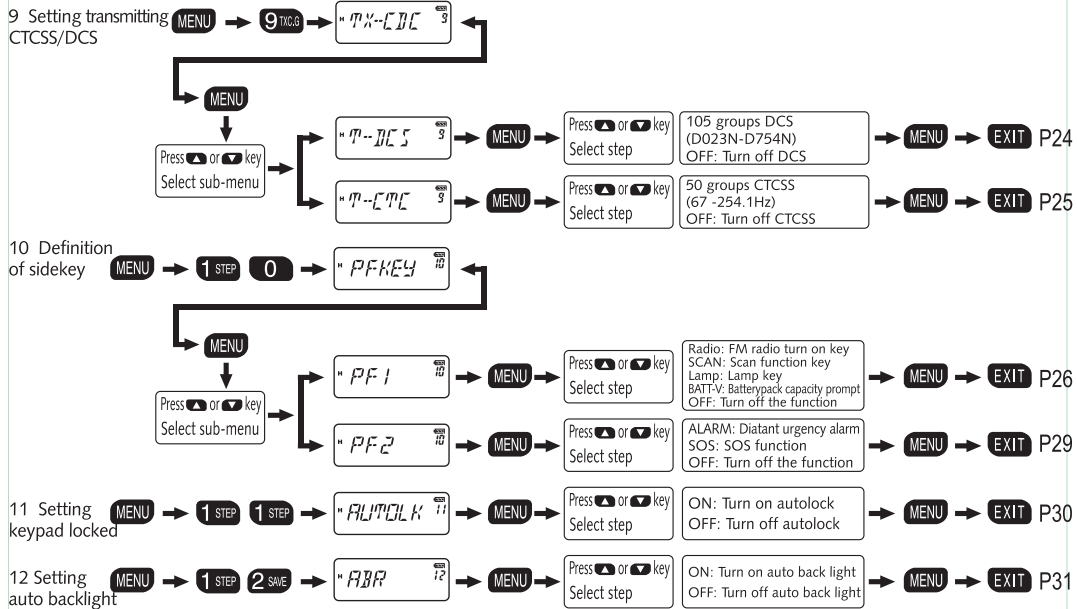

11

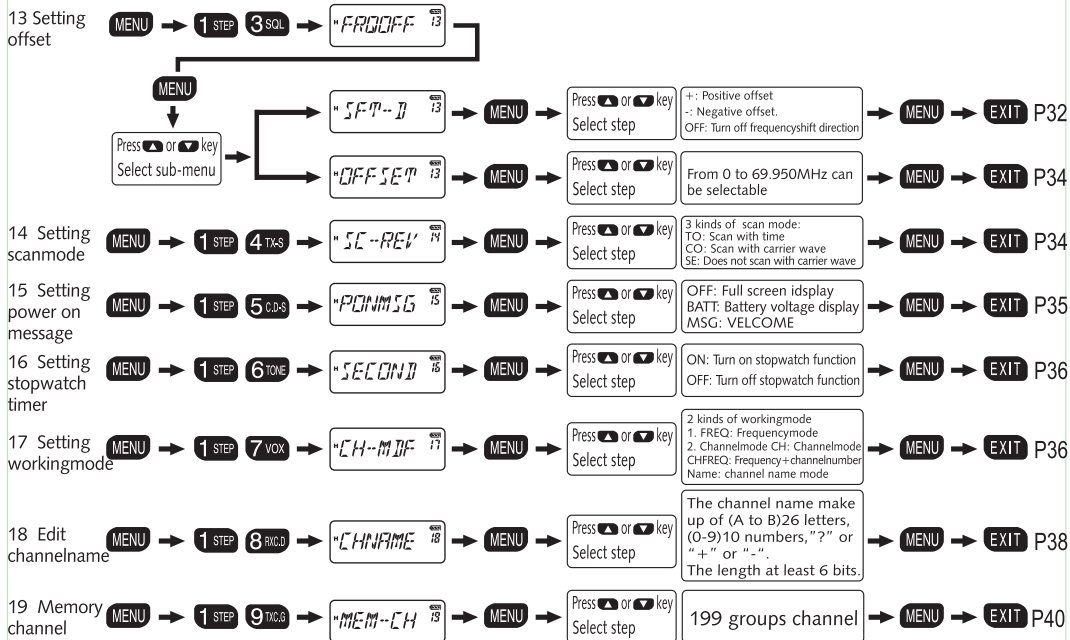

12

Shortcut operation sheet

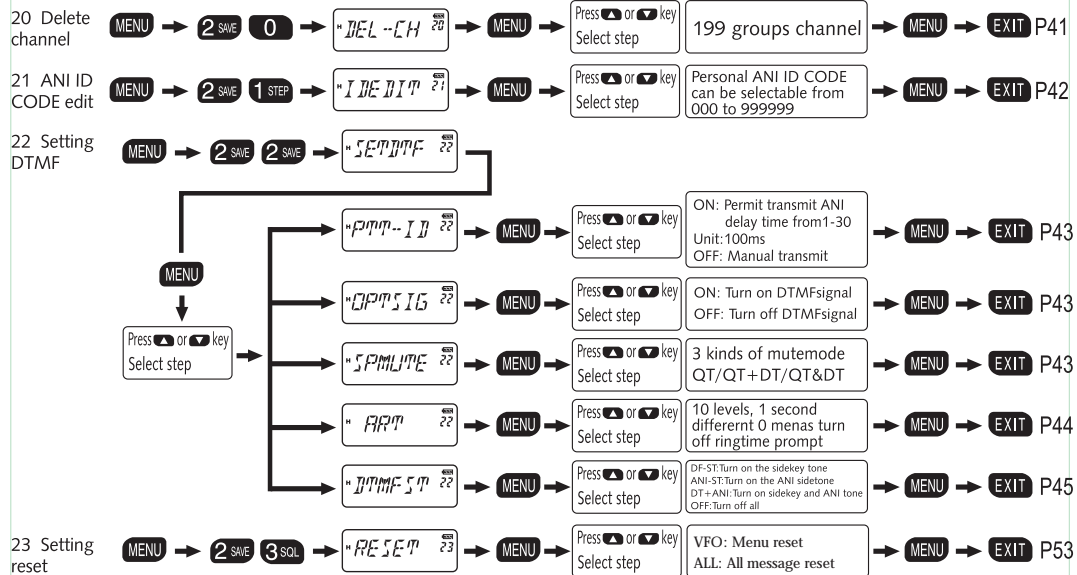

13

- Speed search ▲ / ▼ (See page 7)
- High/Low power changeable when on transmitting (See page 16)
- All calls, group calls and selective calls (See page 46-48)
- Inspection, monitor, stun, kill and emergency (See page 49-52)
- Priority scan function (See page 54)
- Low voltage battery pack voice prompt (See page 55)
- Setting reverse frequency function (See page 54)
- Adding channel scan function (See page 55)
- Wireclone function (See page 55)
- Setting transmit overtime prompt (See page 56)
- Programming repeater function (See page 56)

14

How to operate

Lock menu functions

If you don't need operate menu functions frequently: you can turn off by KG-816 programming software.

The steps as following:

1. Set password of switching between channelmode and frequency mode.
2. Set workmode as channelmode.
3. Turn off operating menu function in channelmode.

Setting frequencystep (STEP) ---- MENU 1

In standby, press **MENU** + number **1 STEP** and the screen will display "STEP 1".

Press **MENU** enter, and then press **▲** / **▼** to select the desired step. Press **MENU** to confirm, and then press **EXIT** to return to standby.

This transceiver has the option of 5 KHz, 6.25 KHz, 12.5 KHz, 25KHz, 50KHz and 100KHz steps.

Setting batterypack savemode (SAVE)----MENU 2

To save battery, this function can turn off the circuit of the receiver a certain time then turn on to check the signal.

In standby, press **MENU** + number **2 SAVE** and the screen will display "SAVE 2".

Press **MENU** enter, press **▲** or **▼** and select ON or OFF.

Press **MENU** to confirm, press **EXIT** to return to standby.

Setting squelch level (SQL-LE) --- MENU 3

This function means turn on the squelch when the signal is strong while turn off the squelch when the signal is weak. Set the same codes and turn on the squelch, the device will "sounds". Setting the level too high may not receive the weaksignals, while setting too low may receive the noise or other no desired signal.

NOTE

» This transceiver has steps from 0-9, which step 0 means to open squelch. From 1 to 9 gives different levels of noise reduction.

In standby, press **MENU** + number **3 SQL** and the screen will display "SQL-LE 3".

Press **MENU** enter, select the squelch of level you need, then press **MENU** to confirm, press **EXIT** return to standby.

How to operate

Setting transmission (TXSET)--- MENU4

This menu has 5 options:

TXP: Selecting transmit power

TOA: Setting transmit overtime alarm

TOT: Transmit overtimer

BCL: Busy channel lock out

W/N: Setting wide or narrow bandwidth

1. Selecting TXP, and it changes transmitpower

NOTE

» (1) Shortcut change on power: High/Low power can be changed during transmit. Press PTT key and  at the same time, which changes High/Low power.

» (2) Shortcut change on power is temporary. When powering on the radio again, the value will be resumed.

2. Transmit overtime alarm is the setting to alarm the user that he/she has reached the preset time(TOT) and a voiceguide and light will flicker during transmit.



This transceiver can be set from 1-10 TOA in steps of 1 second.

17

Level 1 means prompt 1 second before the transmitting time reaches the preset time on transmit over timer (TOT).

In frequency mode, press **MENU** + number **4-TXS** and the screen will display 



Press **MENU** enter, and the screen will display , press  or  and select TOA among TXP, TOT, BCL and W/N functions.

press **MENU** enter, press  or  and select OFF or select 1-10 for the overtime alarm, then press **MENU** to confirm, press **EXIT** return to standby.

3. The TOT is designed to prevent your radio to transmit too long. When the transceiver is exceeding the preset time limit, it will stop transmitting and give you a warning signal.

This transceiver can be set in 40 steps of 15 seconds, between 15 and 600 seconds.

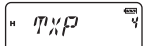
In frequency mode, press **MENU** + number **4-TXS** and the screen will display 

Press **MENU** enter, and the screen will display , press  or  and select TOT function.

Press **MENU** enter, press  or  and select the level you need when on transmitting.

press **MENU** to confirm, press **EXIT** return to standby.

18

How to operate

4. This function is to prevent others from being interfered on communicating. If the selected channel has been used by others, then press PTT the transceiver can't transmit.

In frequency mode, press **MENU** + number **4** TXS and the screen will display " **PTT** " 4

Press **MENU** enter, and the screen will display " **PTT** " 4, press **▲** or **▼** and select BCL function.

Press **MENU** enter, press **▲** or **▼** and select ON or OFF, press **MENU** to confirm, press **EXIT** return to standby.

5. Selecting W/N function, and it sets wide or narrow bandwidth.

In frequency mode, press **MENU** + number **4** TXS and the screen will display " **PTT** " 4

Press **MENU** enter, and the screen will display " **PTT** " 4, press **▲** or **▼** and select W/N function.

Press **MENU** enter, press **▲** or **▼** and select WIDE or NARR bandwidth, press **MENU** to confirm, press **EXIT** return to standby.

CTCSS/DCS frequency scan (SCN CD) ---- MENU 5

The function will scan all CTCSS and DCS frequency in order to confirm that the launcher whether transmit the CTCSS and DCS frequency or not. When your radio could not match with other's radio frequency at the same group, you can use this function to confirm CTCSS and DCS frequency.

When the transceiver is on receiving, press **MENU** + number **5** CD-S and the screen will display " **SCN CD** " 5

Press **MENU** enter, press **▲** or **▼** and select one function of CTCSS and DCS, then press **MENU** to confirm and it start the CTCSS/DCS scan.

NOTE

- » The function doesn't work on channel mode.
- » It will be unable to start the function to scan without detecting the signal.
- » Press **▲** or **▼** or turn the endoder switch to reverse the scan direction.
- » When detecting CTCSS/DCS frequency, the frequency will appear on the screen. Then you can press **MENU** to temporarily replace the current frequency. If you want to directly replace, please enter the CTCSS menu (MENU 8 MENU 9) or DCS menu (MENU 8 MENU 9) to save and confirm. Otherwise it will resume the pre-set value.

How to operate

Setting voice prompt (SETVOC)--- MENU 6

There are 3 options:

VOICE: Setting voiceguids

ROGER: Begin/End transmission prompt

BEEP: Setting beeprompt function

1. This transceiver has a selectable voiceguide in Chinese and English. It will display CHINES when it is Chinese and ENGLSH when it is English.

In frequencymode, press **MENU** + number **6 TONE** and the screen will display **"SETVOC"**

Press **MENU** enter, and the screen will display **"VOICE"**, press **▲** or **▼** and select VOICE function.

Press **MENU** enter, press **▲** or **▼** and select English or Chinese or OFF to switch off the voicguide, then press **MENU** to confirm, press **EXIT** return to standby.

NOTE

» If you want to turn off all the keypad prompt, you must turn off beeprompt function and set voiceguide function at the same time.

2. **ROGER:** means the selection of trasmitting voice prompt.

OFF: Turn off this function, don't transmit voice prompting

BOT: Press PTT, voice prompt transmits

EOT: Release PTT, voice prompt transmits

BOTH: Both pressing and releasing PTT, voice prompt transmits

In frequencymode, press **MENU** + number **6 TONE** and the screen will display **"SETVOC"**

Press **MENU** enter, and the screen will display **"VOICE"**, press **▲** or **▼** and select ROGER function.

Press **MENU** enter, press **▲** or **▼** and select one of OFF, BOT, EOT and BOTH, then press **MENU** to confirm, press **EXIT** return to standby.

3. Beeprompt function is to tell you if the transceiver is operating well or has a malfunction.

We kindly advise you to switch on this function, and the function will inform you for any possible malfunction.

In frequencymode, press **MENU** + number **6 TONE** and the screen will display **"SETVOC"**

Press **MENU** enter, and the screen will display **"VOICE"**, press **▲** or **▼** and select BEEP function.

Press **MENU** enter, press **▲** or **▼** and select ON turn on beeprompt or OFF, then press **MENU** to confirm, press **EXIT** return to standby.

How to operate

Setting VOX (VOX)---MENU 7

When detecting voice, the transceiver will switch to transmit mode automatically.

Since VOX should detect voice, you may note the transmission will be a little delayed. And the first beginning of the voice may not be transmitted.

In standby, press **MENU** +number **7** **VOX** and the screen will display 

Press **MENU** enter, press **▲** or **▼** and select OFF or turn on the 1 to 10 different sensitivity levels,

Press **MENU** to confirm, press **EXIT** to return to standby.

NOTE

- » When level is too high the VOX needs more volume to get activated.
- » When scan or radio is in using, you can not use VOX.

Setting receiving CTCSS/DCS (RX-CDC)--- MENU8

Sometimes maybe you only want to hear the calling which comes from the specific individual or group then you can ignore some (can not hear from others who using the same frequency) calling through CTCSS/DCS. Only then receive the same signal of CTCSS/DCS, the radio will release the mutemode.

There are 2 options:

R-DCS: Setting receiving DCS

R-CTC: Setting receiving CTCSS

1. In frequency mode, press **MENU** +number **8** **RXCDC** and the screen will display 

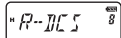
Press **MENU** enter, and the screen will display , press **▲** or **▼** and select R-DCS function, press **MENU** enter, press **▲** or **▼** and select OFF turn off setting DCS or one of the DCS value between D023N and D754N, press **MENU** to confirm, press **EXIT** return to standby.

NOTE

- » This transceiver has 105 groups DCS, see appendix (2) DCS frequency sheet. In it DXXXN (between D023N to D754N) means Positive code while DXXXI (between D023I abd D754I) means Negative code.

How to operate

2. In frequencymode, press **MENU** + number **8**^{FUNC} and the screen will display "R-CTC" 

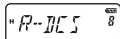
Press **MENU** enter, and the screen will display "R-DCS"  , press **▲** or **▼** and select R-CTC function, press **MENU** enter, press **▲** or **▼** and select OFF turn off CTCSS or one of the CTCSS value from 67Hz to 254.1Hz, press **MENU** to confirm, press **EXIT** return to standby.

NOTE

» This transceiver has 50 groups CTCSS, see appendix (1) CTCSS frequency sheet.

Setting transmitting CTCSS/DCS (TX-CDC)--- MENU9

There are 2 options:

T-DCS: Setting transmitting DCS

T-CTC: Setting transmitting CTCSS

1. In frequencymode, press **MENU** + number **9**^{FUNC} and the screen will display "T-DCS" 

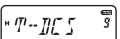
Press **MENU** enter, and the screen will display "T-DCS"  , press **▲** or **▼** and select T-DCS function, press **MENU** enter, press **▲** or **▼** and select OFF turn off setting DCS or one of the DCS value between D023N and D754N, press **MENU** to confirm, press **EXIT** return to standby.

25

NOTE

» This transceiver has 105 groups DCS, see appendix (2) DCS frequency sheet. In it DXXXN (between D023N to D754N) means Positive code while DXXXI (between D023I abd D754I) means Negative code.

2. In frequencymode, press **MENU** + number **9**^{FUNC} and the screen will display "T-CTC" 

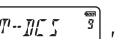
Press **MENU** enter, and the screen will display "T-CTC"  , press **▲** or **▼** and select T-CTC function, press **MENU** enter, press **▲** or **▼** and select OFF turn off setting CTCSS or one of the CTCSS value between 67HZ and 254.1HZ, press **MENU** to confirm, press **EXIT** return to standby.

NOTE

» This transceiver has 50 groups CTCSS, see appendix (1) CTCSS frequency sheet.

26

How to operate

Definition of sidekey ---MENU 10

There are two optional functions on this menu.

1. PF1

There are 5 options:

Radio: Radio function

SCAN: Scan function

LAMP: Lamp function

BATT-V: Battery Voltage function

OFF: Turn off this function

2. PF2

There are 3 options:

ARALM: Start distant urgency alarm function

SOS: SOS function

OFF: Turn off this function

1.1 PF1 RADIO function:

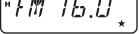
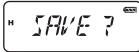
- **Turn on the Radio:** In standby mode, press Side key 1 to turn on. The screen displays  it will search the radio stations automatically when the green light flashing, and will stop until searched. You can listen the radio.
- **Turn the radio stations:** In Radio mode, press ***R**, the radio will tune the stations automatically and the green light flashing at the same time, it will stop tuning while searching the station. You can also press **▲** / **▼** to turn the radio stations.
- **Store the radio stations:** When searching the station, press **MENU** the screen displays 

27

then you can input any number key between **1 STEP** ~ **9 TONE**. The station will be stored into the transceiver's chip, you can listen this station next time.

The transceiver has two groups radio-channels storable. When storing, the default is on the 1st group storage.

E.g. if you want to store 88.1MHz into the 1st group Channel 8, just press **MENU** + **8 RCH**. If you want to store this frequency into the 2nd group Channel 8, firstly, you should select the 2nd storage, press **#**, the screen displays , then switch to the 2nd storage, then press **MENU** + **8 RCH** to store into the 2nd group Channel 8.

For the stored station, under the Radio mode, press number key 1 to 9 to listen it. Use **#** to select the stored stations in 1st and 2nd storage.

- **Exit the Radio:** press Side key 1 again to exit the radio mode.

NOTE

- » When you are listening to the radio, the current frequency or channel is still working. Once receiving signals it will return to the transceiver communicating. After signals disappeared 5 seconds return to Radio mode.
- » When you are listening to the radio, press **EXIT** to check the standby frequency. Press PTT to transmit, 5 seconds later it will return to the Radio mode automatically.

28

How to operate

1.2 PF1 Selecting scan function:

In standby, press sidekey 1, the transceiver enter scan mode (scan mode is up to the scanning setting on MENU 14) During scanning press any key to stop.

1.3 PF1 Selecting lamp function:

In standby, press sidekey 1 to startup lamp, press side key 1 again to trun off lamp.

1.4 PF1 Selecting BATT-V function:

In standby, press sidekey 1 to start up batterypack power prompt function. The screen will display current batterypack voltage.

Note: Press **EXIT** key to exit the function.

The above mentioned functions:

In standby, press **MENU** + number **1 STEP 0** and the screen will display **"PFKEY"**

Press **MENU** enter, and the screen will display **"PF1"**, press **MENU** enter, the screen will display **"RADIO"**. Press **▲** or **▼** select one of SCAN/RADIO/LAMP/BATT-V/OFF functions, press **MENU** to confirm, press **EXIT** return to standby.

2.1 PF2 Selecting ALARM function:

In standby, press PF2 for 2seconds, the speaker will sound alarm. Meanwhile, red and green LED flickers. Press PF2 again to exit.

2.2 PF2 Selecting SOS function:

In standby, press PF2 for 2seconds, the speaker will sound alarm. and transmit alarm tone.

The above mentioned functions:

In standby, press **MENU** + number **1 STEP 0** and the screen will display **"PFKEY"**

Press **MENU** enter, and the screen will display **"PF1"**, press **MENU** enter, the screen will display **"PF2"**. Press **▲** or **▼** select one of ALARM/SOS/OFF functions, press **MENU** to confirm, press **EXIT** return to standby.

How to operate

Setting keyboard lock (AUTOLK) ---- MENU11

The transceiver has two options, auto lock and manual lock. We make most of keys unable to prevent users from wrongl activite some function.

AUTOLK: When you set autolock the keyboard will be locked within 15 seconds if you don't to any operation. To release keyboard press **#→** for more than 2 seconds.

OFF: Turn off auto lock.

In frequencymode, press **MENU** + number **1 STEP** **1 STEP** and the screen will display **AUTOLK**

Press **MENU** enter, press **▲** / **▼** and select ON for autolock or OFF to switch off autolock.

Press **MENU** to confirm, then press **EXIT** to return to standby.

NOTE

» Manual lock: In standby, press **#→** for more than 2 seconds will lock keyboard, release keyboard press **#→** for more than 2 seconds.

Setting auto backlight (ABR) ---- MENU12

This function will make your operation at night easily.

NOTE

» When illuminating the screen and keypad, the backlight will automatically extiguish without pressing any key in 5 seconds. Otherwise, if you press any key will make 5 second-timer recalculate time.

In standby, press **MENU** + number **1 STEP** **2 SAVE** and the screen will display **ABR**

Press **MENU** enter, press **▲** / **▼** and select ON to turn on auto backlight or you want to switch off backlight,

Press **MENU** to confirm, then press **EXIT** to return to standby.

How to operate

frequency shift setting (FRQOFF) ---- MENU 13

There are 2 options:

1. **SFT-D**: Shift frequency direction
2. **OFFSET**: Offset frequency

SFT means that:

1. The transmit frequency is higher than receive frequency. This is called positive offset (+)
2. The transmit frequency is lower than receive frequency. This is called negative offset.(-)
3. Turn off frequencyshift (OFF).

In standby, press **MENU** + number **1 STEP 3 SQL** and the screen will display "FRQOFF 13"

Press **MENU** enter, and the screen will display "SFT-D 13"

Press **MENU** enter, press **▲** / **▼** and select +/-/OFF, press **MENU** to confirm, then press **EXIT** to return to standby.

NOTE

» It can not transmit if the frequencyshift is exceeding the permitted range. In this condition, to adjust the receiving frequency or frequencyshift and make the transmit frequency in a permitted range.

Offsetfrequency is the difference between the transmit and receive frequency. The transceiver offset range can be from 0 to 69.950MHz.

In standby, press **MENU** + number **1 STEP 3 SQL** and the screen will display "FRQOFF 13"

Press **MENU** enter, the screen will display "SFT-D 13", press **MENU** enter, the screen will display "OFFSET 13".

Press **MENU** enter, press **▲** / **▼** and select +/-/OFF, press **MENU** to confirm, then press **EXIT** to return to standby.

Only in frequency mode, frequency shift direction and offset frequency can be used that can make transmitting/receiving works on different frequencies.

Steps:

1. Setting receiving frequency.
2. Setting offset frequency direction and offset frequency.
3. Setting CTCSS/DCS frequency (if necessary).

E.g. The receiving frequency of a repeater is 460.025MHz. The receiving CTCSS is 69.3Hz. The transmitting frequency is 450.025MHz.

1. Setting receiving frequency in frequency mode, or derly input 450025.
2. Setting offset frequency in frequency mode, enter SFT-D on MENU 13 (Please see P32) and select "+".
3. Setting offset frequency in frequency mode, enter OFFSET on MENU 13 and selet "10.000".

How to operate

4. Setting transmitting CTCSS/DCS: in frequency mode, enter T-CTC on MENU 9 (Please see P25) and select "69.3".

NOTE

» In order to use this function easily, you can store the above frequencies and related data on channels. In this case, you don't need to reset it. Please refer the operation of memory channels on MENU 19 (P40).

Setting scanmode (SC-REV) ---- MENU 14

The transceiver will stop scanning when detect the frequency(memory channel) of signal. According to the method of restoring that you selected, the transceiver will resume or stop scanning.

The transceiver has three scanmodes.

TO: After signal in channel disappears the transceiver will start scanning if you don't any operation within 5 seconds.

CO: After the transceiver stopped on a signal it will resume scanning again in 3 seconds when signal disappears.

SE: Scanning will stop when receives a signal.

35

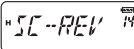
In standby, press **MENU** + number **1 STEP 4 TV-S** and the screen will display 
Press **MENU** enter, press **▲** / **▼** and select TO, CO or SE.
Press **MENU** to confirm, then press **EXIT** to return to standby.

NOTE

» Pressing ***F** for 2 seconds to enter scan mode.

Setting power on message (PONMSG) ---- MENU 15

Transceiver power on message:

FULL: Full display **BATT-V:** Display the current voltage of batterypack **MSG:** WELCOME

In standby, press **MENU** + number **1 STEP 5 C.D-S** and the screen will display 

Press **MENU** enter, press **▲** / **▼** and select FULL/BATT-V/ MSG.

Press **MENU** to confirm, then press **EXIT** to return to standby.

36

How to operate

Setting Stopwatch function (SECOND) ---- MENU 16

In standby mode, Press **MENU** and number **1 STEP 6 TONE** key, the screen will display "SECOND" 

Press **MENU** enter, and then press **▲** / **▼** to select ON or OFF, press **MENU** to confirm, then press **EXIT** to return to standby.

Usage of stopwatch:

When the stopwatch function is ON, press **#---**, it begin timing, press any key to stop it. Press **#---** to resume.

NOTE

» When the stopwatch function stops, press any key (except **#---**) to exit.

Working mode (CH-MDF) --- MENU 17

This transceiver has two working modes available:

1. Frequency mode (FREQ)
2. Channel mode

Three kinds of channel mode available:

- ① Channel (CH)
- ② Frequency + Channel number (CH FREQ)
- ③ Channel name (NAME)

37

NOTE

- » Only input the shift password can change Frequency mode into Channel mode, while change among the three kinds of channel mode without inputting password.
- » To set the shift password via the supplied programming software.
- » Set the password with six "0" is invalid (turn off the Shift password function) while set not full of "0" is valid.

Frequency (FREQ) and Channel mode changeable

① Invalid password

In standby, press **MENU** + **1 STEP 7 VOX**, the screen will displays "CH-MDF" 

Press **MENU** enter, then press **▲** / **▼** to choose working mode press **MENU** to confirm,

② Valid password

In standby, press **MENU** + **1 STEP 7 VOX**, the screen will displays "CH-MDF" 

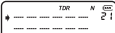
Press **MENU** enter, then press **▲** / **▼** to choose working mode press **MENU** to confirm, the screen displays six short line  Input the password, the transceiver shift to the selective mode.

38

How to operate

NOTE

- » Channel mode and channel name mode can shift only after stored at least one channel and one named channel.
- » Speedy switch over frequency mode and channel mode (CH).
In standby press **MENU** + **AIL**. If you don't set the switching code, you can switch the mode directly.
If the passcode has been set, you should firstly input the code to switch it.

Channel name Edit (CHNAME) --- MENU 18

Edit Channel name:

1. Channel name should be within 26 letters (A to Z) and 10 numbers (0 to 9).
2. Channel name should be less than six length.
3. When selecting (-) means the bit is blank.

Edit method:

1. Via programming software.
2. Via keypad of transceiver.

Editing:

1. At least one channel should have been stored.

39

2. The transceiver should be in Channel mode.
3. Enter channel name edit, press **▲** to select character while press **▼** to select edit position.

Edit step:

1. If the transceiver works in frequency mode, set the workmode as CH or CHFREQ (See MENU17).
2. Select the desired edit channel, press **MENU** + **1 STEP** + **8 PWD** + **MENU**, and then the screen display 6 digits, press **▲** and select the character then press **▼**, press **▲** again to select the second character, after selecting the sixth character press **MENU** to confirm, press **EXIT** to exit. The screen will displays the channelname and show the order of this channel on top rightcorner.
3. If the transceiver works in CH mode, then go through MENU 17 set the display to NAME.

40

How to operate

Setting memory channel (MEM-CH) ---- MENU 19

When transceiver works in frequency mode and is in standby mode, you can input the frequency and each parameter what you want to store.

Press **MENU** + number **1 STEP 9 TNCG** and the screen will display **"MEM-CH 19"**

Press **MENU** enter, press **▲** / **▼** and select channel, press **MENU** to store and you will hear an voiceprompt if it is stored.

Press **EXIT** to exit, at this moment the channel should be co-channel frequency channel.

When you need to store dis-channel, repeat the above procedure, after you stored, you will hear a voiceprompt "store transmit".

Eg: You want 450.025MHz for receive and 460.025MHz for transmit and stored in CH-20, then act as follows:

1. When the transceiver works in frequency mode, input **4 TX-S 5 C.D-S 0 0 2 SWE 5 C.D-S**, **MENU** + **1 STEP 9 TNCG** + **MENU**, then press **2 SWE 0** or **▲** / **▼** and select CH-20, press **MENU** key to confirm, voiceprompt will tell you it is stored, press **EXIT** to exit;
2. Then input **4 TX-S 6 TONE 0 0 2 SWE 5 C.D-S** + **MENU** + **1 STEP** + **9 TNCG** + **MENU** + **MENU** and voiceprompt will tell you it is stored + press **EXIT** to exit.

41

3. The dis-channel is stored.

NOTE

- » If the stored channels need to set the CTCSS/DCS codes, you should set it before you stored, so that you can store into channel with frequency.
- » Transmitting store only can store transmitting frequency.
- » Manual store, in frequency mode, only when the channel is empty it can set receiving and transmitting store, or only can set transmitting store. If channel is not empty, the transceiver only can set receiving and transmitting store once the channel deleted.
- » Besidees manual store, via programming software can also set the functions and parameters.

Delete channel (DEL-CH) ---- MENU 20

In standby, press **MENU** + number **2 SWE 0** and the screen will display **"DEL-CH 20"**

Press **MENU** enter, press **▲** / **▼** to select the channel you want to delete, press **MENU** to confirm.

The select channel and message are deleted, press **EXIT** to return to standby.

42

How to operate

ANI ID CODE edit (IDEDIT)----MENU 21

In frequency mode, Press **MENU** and number **2 SAVE 1 STEP** key, the screen will display . Press **MENU** enter, input the ID CODE directly in which you need, press **MENU** to confirm, then press **EXIT** to return to standby.

NOTE

» ID CODE on this transceiver is made up of 3-6 digits, and can be edited freely. ID CODE selectable range from 000 to 999999.

Setting DTMF (SETDTF)----MENU 22

The menu has 5 options:

PTT-ID: Setting ANI ID CODE transmit delay

OPTSIG: Setting DTMF signal

SPMUTE: Setting mutemode

ART: Setting ringtime

DTMFST: Setting DTMF sidetone

43

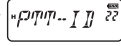
1. Setting ANI ID CODE transmit means that when you are communicating, every time press the PTT key, the ANI ID CODE will be auto or manual transmitted.
 - ① **1-30:** Preset transmit ANI delay time from 1 to 30. Unit:100ms
 - ② **OFF:** Transmit ANI ID CODE manuallyIn standby mode, Press **MENU** and number **2 SAVE 2 SAVE** key, the screen will display . Press **MENU** enter, and the screen will display , press **▲** / **▼** and select PTT-ID function. Press **MENU** enter, and then press **▲** / **▼** and select 1 to 30 for delay transmit ANI or OFF to switch off ANI delay transmit, press **MENU** to confirm, then press **EXIT** to return to standby.
2. Setting to start DTMF means enabling selective calls, group calls and all calls function.

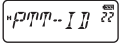
In standby mode, Press **MENU** and number **2 SAVE 2 SAVE** key, the screen will display . Press **MENU** enter, and the screen will display , press **▲** / **▼** and select OPTSIG function. Press **MENU** enter, and then press **▲** / **▼** and select ON turn on DTMF or OFF turn off DTMF signal, then press **MENU** to confirm, then press **EXIT** to return to standby.
3. The mutemode is to turn on/off the speaker audio according to your optional signal setting. This transceiver has three kinds of mode which can be selected.

44

How to operate

QT: When the transceiver receive a signal and matching CTCSS tone it will turn on speaker output. When the transceiver has not set a CTCSS tone and a signal is received you will hear that through the loudspeaker.

QT + QT: When the transceiver received matching QT and DTMF signal, it will turn on the speaker.

QT X QT: When the transceiver received matching QT and QT+DT , it will turn on the speaker.

In standby mode, Press **MENU** and number **2 SANE 2 SANE** key, the screen will display "CTCSS 00". Press **MENU** enter, and the screen will display "CTCSS- I II 00", press **▲** / **▼** and select SPMUTE function. Press **MENU** enter, and then press **▲** / **▼** and select one of QT or QT+DT or QT X DT, then press **MENU** to confirm, then press **EXIT** to return to standby.

4. Setting DTMF sidetone gives you the opportunity to switch on or off the speaker and hear the corresponding DTMF tone when transmit DTMF.

In standby mode, Press **MENU** and number **2 SANE 2 SANE** key, the screen will display "CTCSS 00". Press **MENU** enter, and the screen will display "CTCSS- I II 00", press **▲** / **▼** and select ART function. Press **MENU** enter, and then press **▲** / **▼** and select one of the ring time from 0 to 10, then press **MENU** to confirm, then press **EXIT** to return to standby.

45

5. Setting DTMF sidetone gives you the opportunity to switch on or off the speaker and hear the corresponding DTMF tone when transmit DTMF.

The transceiver has 4 different options:

- ① **DT-ST:** Switch on sidekey when transmitting
- ② **ANI-ST:** Switch on the ANI sidetone when transmitting
- ③ **DT+ANI:** Sidekey and ANI sidetone are both on when transmitting.
- ④ **OFF:** Turn off all

In standby mode, Press **MENU** and number **2 SANE 2 SANE** key, the screen will display "CTCSS 00". Press **MENU** enter, and the screen will display "CTCSS- I II 00", press **▲** / **▼** and select DTMFST function. Press **MENU** enter, and then press **▲** / **▼** and select one function of DT-ST/ANI-ST/DT+ANI/OFF, then press **MENU** to confirm, then press **EXIT** to return to standby.

46

How to operate

All calls, group calls and selective calls

The transceiver has the function of transmit ANI ID CODE, edit ANI ID CODE and decoding DTMF, without by other tool, user can achieve all calls, group calls and selective calls.

Prepare work of use all calls, group calls and selective calls.

1. ID CODE edit **NOTE:** Every transceiver in the group needs a unique ANI ID CODE.

ANI ID CODE---XXX

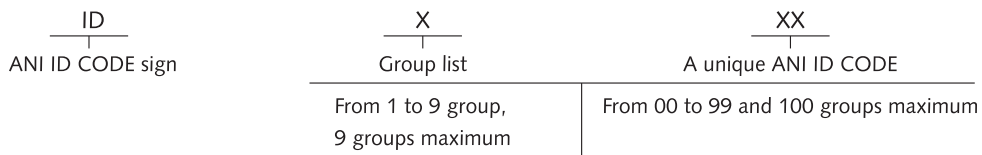

This is how to build up ANI ID CODE.

The steps of setting ANI ID CODE:

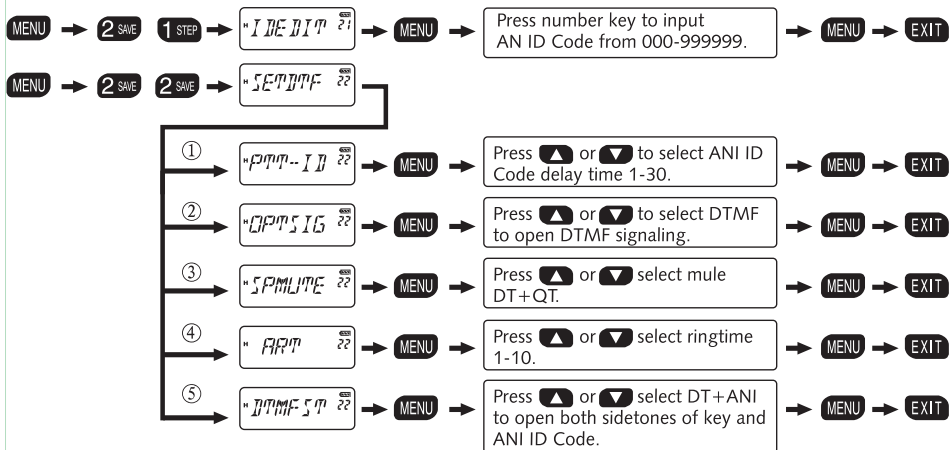

NOTE

» All transceivers in the same group must set the same frequency, channel and parameter.

How to operate

a. Using all calls function:

Press PTT key input *R + # directly by keyboard after sending ANI ID Code of the transceiver.

b. Using group calls function:

Press PTT key, input group number + *R + # directly by the keyboard after sending ANI ID Code of the transceiver. (Taking 3 digits of ANI ID Code as an example).

Note: If the ANI ID Code of the other party is 0 digits, input group number + *R + *R.

c. Using selective calls function:

Press PTT key, input the ANI ID CODE in which you want to call directly by the keyboard after sending ANI ID Code of this transceiver.

Note: When pressing PTT key to transmit, if you press number key to transmit DTMF code, the transmission will delay for 2seconds, and then the transmission stop.

Inspection, monitor, stun, kill

Inspection:

Manager can use this function when he/she want to know whether their staff are on the working; manager send the inspection signal, and the member's transceiver in the group will reply to the manager automatically(what it replied is the ANI ID CODE).

Stun:

Manager can use this function when he/she only want to let their member receive and can't transmit. Manager only need to stun the member's radio and after this over, to activate it through transmit the power on signal when needed.

Kill:

When the radio was lost or other special circumstance happened,in order to let others disable to transmit and receive ,manager can use this function to kill the radio.

Monitor:

Manager can use this function when he/she want to know what their staff are doing at the moment. When manager transmit the monitor signal, the member's transceiver in the group will transmit automatically, then manager can hear the member's voice.

How to operate

Eg.

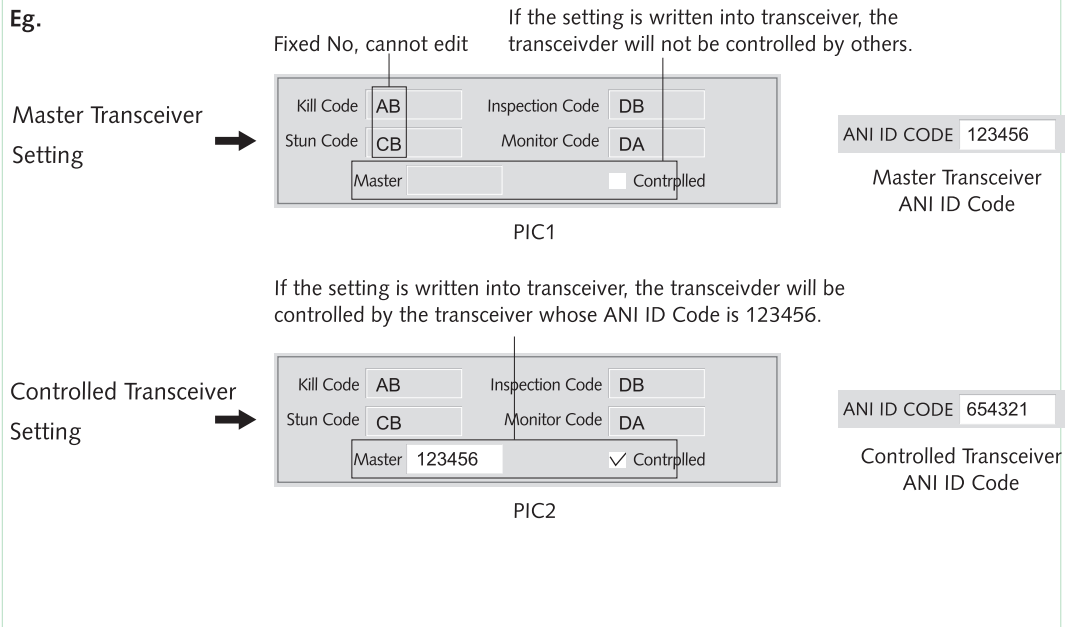

51

The way of controlling the controlled transceiver, analysis together with PIC1 & PIC2 is as follows:

1. Auto Transmission ANI ID CODE + Manual Transmission Controlled Code + Controlled Transceiver ANI ID Code.

- Editing MENU 21 to 123456.
- Setting PTT-ID on MENU 22 as one of 1-30. (If it will be passed working repeater, the time should be set longer).
- Setting DTMFST on MENU 22 as DT+ANI (you can hear transmission code sound).
- At this time press PTT key to transmit. After sending ANI ID Code, press the controlled code (eg. Kill code AB) on keypad.

2. All Manually Transmitting Code.

- Setting DTMFST on MENU 22 as DT+ANI (you can hear transmission code sound).
- Holding PTT key on to transmit, at the same time press master ANI ID Code (123456) on keypad, and then press controlled code (eg. Kill code AB). At last press ANI ID Code (654321) of the wanting controlled transceiver.

52

How to operate

NOTE

- » You only need to write the parameters on PIC1 & PIC2 into the transceiver, and the frequency of master and controlled transceiver is the same. The inspection, stun, kill and monitor function can be valuable.
- » When the master code is 3-5 digits, you need to add "#" code after sending master ANI ID Code if you transmit the code all manually. And then you can transmit controlling and controlled ANI ID Code. If you transmit ANI ID Code automatically, you don't need to transmit extra "#" code.
- » You only need to transmit stun code again to revive the stunned transceiver.
You only need to transmit kill code again to revive the killed transceiver.

Setting reset (RESET) ---- MENU 23

The transceiver has a menu which resets VFO and ALL messages.

When you use RESET VFO all parameters of menu will return to factory set.

When you use RESET ALL all menu and channel parameters will return to factory set.

1. MENU reset (VFO):

In standby, press **MENU** + number **2** **SAVE** **3** **SQ** and the screen will display 

Press **MENU** enter, press **▲** / **▼** select VFO, press **MENU** key and the screen will display 

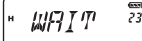
Press **MENU** again and the screen will display 

When the reset has worked well the transceiver will auto power off and auto switch on again.

2. All message reset (ALL):

In standby, press **MENU** + number **2** **SAVE** **3** **SQ** and the screen will display 

Press **MENU** enter, press **▲** / **▼** select ALL, press **MENU** key and the screen will display 

When reset has worked well, the transceiver will auto power off and auto switch on again.

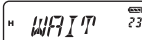
Press **MENU** again and the screen will display 

How to operate

Setting Priority Scan Function

If you want to monitor the other frequency and check the certain preferred frequency at the same time, you can set Priority scan function.

E.g.: Scan six channels: CH1, CH2, CH3, CH4 and CH5 as the common scanned channel, and CH6 set as the priority scanned channel. Scanning sequence as following chart:

CH1 – CH6 – CH2 – CH6 – CH3 – CH6 – CH4 – CH6 – CH5 – CH6

If the transceiver checks the signal on "Priority Channel", it will call out its frequency. Select the priority channels via programming software.

Setting Reverse Frequency function

When using reverse frequency function, the transmitting and receiving frequency of transceiver will interchange, and the CTCSS and DCS encode and decode will interchange either.

Operating reverse frequency function:

In standby mode, press ***R** to turn on the reverse frequency function; press ***R** again to turn off.

Low-voltage battery Voice Prompt

When the battery pack has low voltage, the transceiver will sound "low battery pack", and the LED will flash every 5 seconds and a "click" sounds.

Adding scanning channel

NOTE

- » Channel scan only according to scan list which had been added.
- » Edit method: Strictly via programming software.

Wire clone function

Using wireclone	Switch sourceradio on, after you have connected the targetradio to the sourceradio via the cloningcable, push the [MONI] key and the sourceradio starts cloning.	LED is flashing red during cloning. LED goes out in case of successful cloning. LED glows continuous red in case of cloning failure.
	Targetradio	LED is flashing green during cloning. LED will switch OFF when cloning complete.

How to operate

Setting transmit Overtime Prompt

When transceiver transmits beyond the limited time, there will be a sound warning "transmit overtime", and stop transmitting. Press PTT to transmit again. (Setting Transmit Over Timer pls see page 16)

Programming repeater function

Most repeaters use standard or different splits and/or matching CTCSS/DCS or DTMF signals.

When you need to join a repeater, you need to set different parameters on receive and transmit.

In this case, the transceiver should be set different parameters and stored on the appointed channels.

The transceiver will build up communication via this channel.

Eg.: The repeater transmit frequency is 450.025MHz, CTCSS value is 67Hz, receive frequency for 460.025MHz. CTCSS value for 254.1Hz. transmitting frequency for 460.025MHz.

How to use your intelligent charger

The intelligent charger is including adaptor and intelligent charger.

feature and characteristic:

Intelligent charger have trickle charge power, constant voltage charging, constant-current charge in three modes, on the charge of the battery charging process in the different voltages, automatic conversion, more efficient battery charging and protection of life and the same time, there are short-circuit protection and battery temperature detection protection.

The instruction of how to use the intelligent charger:

- 1.** The one end of the power adaptor and the intelligent charger are connected, and the other end into socketgrid, the red light flash, and the intelligent chargers to be standby charger.
- 2.** Insert the battery pack, red light continuously shines, now it is charging.
- 3.** When the green light continuously shines, the charging is completed.

How to operate

NOTE

- » When your batteries pack run out of power in the walkie-talkie, insert charger, red lights will be flashing 10-20 minutes, which is a normal phenomenon. To run out of battery power, Intelligent charger to trickle charge for battery power to pre-charge. It is battery pack protection.
- » Insert the battery pack when the power did not run out of power, and the intelligent charger has a red light flashing, because: It may be a battery pack with intelligent charger bad, please re-insert. May be inserted into the battery temperature is too high when the battery pack cooling, re-insert the charging.

Trouble shooting

Please check carefully if your transceiver has problems by following this chart.

If you maintain to have trouble you can reset your transceiver and very often this will eliminate your problem.

Problem	Solution
Cannot power on, no power	<ol style="list-style-type: none">1. The battery may exhausted, pls change the new battery or re-charge.2. The battery install incorrect, pls take out the battery and re-install.
Battery life not long	<ol style="list-style-type: none">1. The battery life is over, pls change a new battery.2. Not charging completely, be make sure fully charged before take out.
Receive light turn on but no sounds	<ol style="list-style-type: none">1. Make sure the volume is highest2. Make sure the CTCSS/DCS code is the same with other members.3. Make sure if you set the right mute.
Keypad do not work	<ol style="list-style-type: none">1. Make sure the keypad is locked or not.2. Make sure any other key stuck.
In standby, it will auto- transmit without pressing PTT	Make sure VOX function is ON or not, and its level is set too low or not.

Trouble shooting

Problem	Solution
Some functions can not be stored	Make sure work in Channel mode. Some functions can be set only via programming software in Channel mode.
Receive other groups signal while communicating	Pls change another CTCSS/DCS code of your group.

Technology parameter

Appendix 1

CTCSS									
1	67.0	11	94.8	21	131.8	31	171.3	41	203.5
2	69.3	12	97.4	22	136.5	32	173.8	42	206.5
3	71.9	13	100.0	23	141.3	33	177.3	43	210.7
4	74.4	14	103.5	24	146.2	34	179.9	44	218.1
5	77.0	15	107.2	25	151.4	35	183.5	45	225.7
6	79.7	16	110.9	26	156.7	36	186.2	46	229.1
7	82.5	17	114.8	27	159.8	37	189.9	47	233.6
8	85.4	18	118.8	28	162.2	38	192.8	48	241.8
9	88.5	19	123.0	29	165.5	39	196.6	49	250.3
10	91.5	20	127.3	30	167.9	40	199.5	50	254.1

Technology parameter

Appendix 2

DCS

1	D023N	16	D074N	31	D165N	46	D261N	61	D356N
2	D025N	17	D114N	32	D172N	47	D263N	62	D364N
3	D026N	18	D115N	33	D174N	48	D265N	63	D365N
4	D031N	19	D116N	34	D205N	49	D266N	64	D371N
5	D032N	20	D122N	35	D212N	50	D271N	65	D411N
6	D036N	21	D125N	36	D223N	51	D274N	66	D412N
7	D043N	22	D131N	37	D225N	52	D306N	67	D413N
8	D047N	23	D132N	38	D226N	53	D311N	68	D423N
9	D051N	24	D134N	39	D243N	54	D315N	69	D431N
10	D053N	25	D143N	40	D244N	55	D325N	70	D432N
11	D054N	26	D145N	41	D245N	56	D331N	71	D445N
12	D065N	27	D152N	42	D246N	57	D332N	72	D446N
13	D071N	28	D155N	43	D251N	58	D343N	73	D452N
14	D072N	29	D156N	44	D252N	59	D346N	74	D454N
15	D073N	30	D162N	45	D255N	60	D351N	75	D455N

Technology parameter

DCS

76	D462N	82	D516N	88	D606N	94	D645N	100	D723N
77	D464N	83	D523N	89	D612N	95	D654N	101	D731N
78	D465N	84	D526N	90	D624N	96	D662N	102	D732N
79	D466N	85	D532N	91	D627N	97	D664N	103	D734N
80	D503N	86	D546N	92	D631N	98	D703N	104	D743N
81	D506N	87	D565N	93	D632N	99	D712N	105	D754N

Technology specification

Frequencyrange	VHF: 136-174MHz/245-250MHz/216-280MHz/225-226MHz UHF: 400-470MHz/350-390MHz/400-480MHz/420-520MHz/ 403-469.9875MHz	
Memorychannels	199 channels	
Voltage	7.4V DC	
Working temperature	-30C(-22F) to +60C(140F)	
Channels	Co-channel or Dis-channel simplex	
Poweroutput	VHF: 5W / UHF:4W	
Mode	F3E(FM)	
Maximum deviation	≤ ±5KHz	
Adjacent channel power	< -60dB	
Stability	±5 ppm	
Sensitivity	< 0.2 μV	
Audio output power	≥ 700mW	
Weight	216g	
Size	100.6 X 56.5 X 33 (mm)	3.96x2.22x1.30(inch)

NOTE

» Specifications are subject to change without notice.

Optional accessories

 Professional FM Transceiver

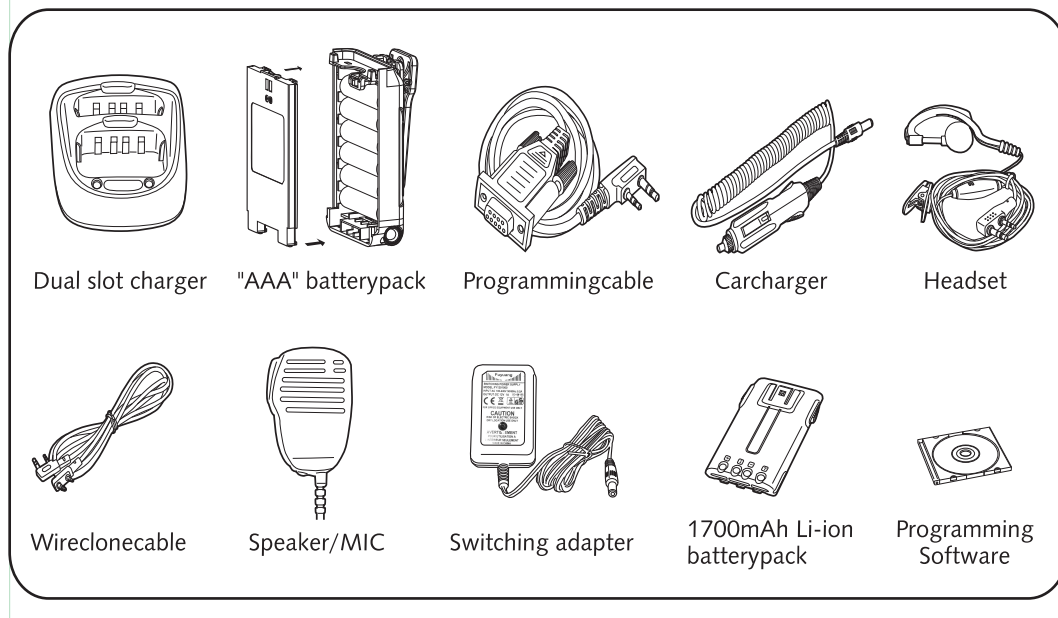

Announce

Wouxun endeavors to achieve the accuracy and completeness of this manual, but is not liable for any possible omission and printing errors. All the above specifications are subject to change by *Wouxun* without prior notice.

English Version: KG-816-0910-V1