

Thanks for buying the  WOUXUN transceiver.

This transceiver offers latest design, enhanced features, solid performances and easy accessibility. We believe you will be pleased with the high quality and reliable features for all your communication needs.

READ THIS IMPORTANT INFORMATION ON THE SAFE AND EFFICIENT OPERATION BEFORE USING  WOUXUN PORTABLE TRANSCEIVER. This manual is ONLY suitable for KG-D901 VHF/UHF.

User Safety, Training, and General Information

READ THIS IMPORTANT INFORMATION ON SAFE AND EFFICIENT OPERATION BEFORE USING YOUR **Wouxun** PORTABLE TWO-WAY RADIO.

Compliance with RF Energy Exposure Standards

Your **Wouxun** two-way radio is designed and tested to comply with a number of national and international standards and guidelines (listed below) regarding human exposure to radio frequency electromagnetic energy. This radio complies with the IEEE (FCC) and ICNIRP exposure limits for occupational/controlled RF exposure environment at duty cycles of up to 50% talk-50% listen and should be used for occupational use only. In terms of measuring RF energy for compliance with the FCC exposure guidelines, your radio radiates measurable RF energy only while it is transmitting (during talking), not when it is receiving (listening) or in standby mode.

NOTE

» The approved batteries supplied with this radio are rated for a 5-5-90 duty cycle (5% talk-5% listen-90% standby), even though this radio complies with the FCC occupational RF exposure limits at duty cycles of up to 50% talk.

Your **Wouxun** two-way radio Complies with the following of RF energy exposure standards and guidelines:

- United States Federal Communications Commission, Code of Federal Regulations; 47CFR part 2 sub-part J
- American National Standards Institute (ANSI)/Institute of Electrical and Electronic Engineers (IEEE) C95. 1-1992
- Institute of Electrical and Electronic Engineers (IEEE) C95. 1-1999 Edition
- International Commission on Non-Ionizing Radiation Protection (ICNIRP) 1998

Operational Instructions and Training Guidelines

To ensure optimal performance and compliance with the occupational/controlled environment RF energy exposure limits in the above standards and guidelines, users should transmit no more than 50% of the time and always adhere to the following procedures:

Transmit and Receive



To transmit (talk), push the Push-To-Talk (PTT) button; to receive, release the PTT button.

Hand-held radio operation





Hold the radio in a vertical position with the microphone 5 cm away from the lips and keep the antenna

far away from your head.

Body-worn operation

Always place the radio in an  approved clip, holder, holster, case, or body harness for this product. Use of non- -approved accessories may exceed FCC RF exposure guidelines.

Antennas & Batteries

- Use only  approved, supplied antenna or  approved replacement antenna.
- Unauthorized antennas, modifications, or attachments could damage the radio and may violate FCC regulations.
- Use only  approved, supplied batteries or  approved replacement batteries.
- Use of non- -approved batteries may exceed FCC RF exposure guidelines.



Approved Accessories

For a list of  approved accessories, see the accessories page of this user manual or visit the following website which lists approved accessories: <http://www.wouxun.com>

Notices to the User

- Government law prohibits the operation of unlicensed radio transmitters within the territories under government control.
- Illegal operation is punishable by fine or imprisonment or both.
- Refer service to qualified technicians only.

Warning

- » It is important that the operator is aware of and understand hazards common to the operation of any transceiver. Explosive environment (such as gases, dust, fumes, etc). Turn off your transceiver while talking on fuel, or parking in gasoline service stations.
- » If you require this machine to be developed or get some changes, please contact with  or your  dealer.

FCC Caution:

This equipment has been tested and found to comply with the part 90 of the FCC Rules. These limits are designed to provide reasonable protection against harmful interference in a residential installation. This equipment generates, uses and can radiate radio frequency energy and, if the equipment is not installed and used in accordance with the instructions, it may cause harmful interference to radio communications. However, there is no guarantee that interference will not occur in a particular installation. If this equipment

does cause harmful interference to radio or television reception, which can be determined by turning the equipment off and on, the user is encouraged to try to correct the interference by one or more of the following.

Measures:

- Reorient or relocate the receiving antenna.
- Increase the separation between the equipment and receiver.
- Connect the equipment into an outlet on a circuit different from that to which the receiver is connected.
- Consult the dealer or an experienced radio/TV technician for help.

FCC Licensing Requirements

Your radio must be properly licensed Federal Communications Commission prior to use. Your  Wireless dealer can assist you in meeting these requirements. Your dealer will program each radio with your authorized frequencies, signaling codes, etc., and will be there to meet your communications needs as your system expands.

Precautions

Only qualified technicians are allowed to maintain this product.
Do not use the radio or charge a battery in explosive areas such as coal gas, dust, steam, etc.

Switch OFF the radio while refueling or parking at a gas station.

Do not modify or adjust this radio without permission.
Do not expose the radio to direct sunlight over a long time, nor place it close to heat source.
Do not place the radio in excessively dusty, humid areas, nor place close to heating appliances.
Safety: It is important that the operator is aware of and understands hazards common to the operation of any radio.

Warning

» MODIFICATION OF THIS DEVICE TO RECEIVE CELLULAR RADIOTELEPHONE SERVICE SIGNALS IS PROHIBITED UNDER FCC RULES AND FEDERAL LAW.

CE Caution:

Hereby,  declares that this Two-way radio is in compliance with the essential requirements and other relevant provisions of Directive 1999/5/EC.

A copy of the DOC may be obtained through the following address.

Address: No.928 Nanhuan Road, Jiangnan High Technology Industry Park, Quanzhou, Fujian 362000,
China

Contents



Professional DMR Transceiver

Attention	01
Product Inspection	02
Battery Information	03
Attention to charging	03
Charging Information	03
Care and Cleaning	04
Accessory Installation	05-08
Battery Installation and Remove	06
Antenna Installation and Remove	06
Beltclip Installation and Remove	07
MIC/Speaker and Earphone Installation	07
Digital Repeating Channel Setting	09
Learning Transceivers	10-11
Button Setting	12-15
LCD Screen	16-17
LED Indicator	18

Contents

Basic Operations	19-20
<i>Turning ON/OFF transceiver</i>	19
<i>Channel Selection</i>	19
<i>Volume Control</i>	19
<i>Transmitting</i>	19
<i>Receiving</i>	19
<i>Respond to Call</i>	20
<i>Backlight</i>	20
Channel Edit	21-23
<i>Program TX/RX Frequencies</i>	22
<i>Program Color Code(Digital Mode)</i>	22
<i>Program Bandwidth(Analogue Mode)</i>	22
<i>Program TX/RX Tone(Analogue Mode)</i>	22-23
Menu	24-32
<i>MENU in Digital Mode</i>	24
<i>MENU in Analogue Mode</i>	32

Contents



Professional DMR Transceiver

Functions and Operations	33-48
<i>Radio ID Setting</i>	33
<i>Record</i>	33
<i>Text Message</i>	33
<i>Short Message(CommMsg)</i>	34
<i>One Touch Access</i>	35
<i>Keypad Lockout</i>	35
<i>Transmission Overtime Forbidden (TOT)</i>	35-36
<i>Language Setting</i>	36
<i>Power Saving</i>	36
<i>Power Saving Start Timeout</i>	36
<i>Squelch Setting</i>	36
<i>VOX Setting</i>	37
<i>Key Tone</i>	37
<i>Battery Tone</i>	37
<i>Zone Setting</i>	38

Contents

Channel Name	38
Scan	38
Scan List	38-39
Tx Reply Channel	39
Residence Time	39
TX Residence Time	39
Double Priority Channel Scan	40-41
Color Code Setting	41
Relay Slot	41-42
Emergency System	42
Access Poltics	42
Private Call Setting	43
Digit Contact	43
Receiving Group List	43
Digit Encryption	44
Talk Around	44

Contents



Professional DMR Transceiver

Disable, Enable, Check	44-45
DMR Basic Setting	45-46
DTMF Signalling Setting(Analogue Mode)	47-48
PC Programming Password	48
Frequency Sheet	49-50
CTCSS Standard List	49
DCS Standard List	50
Trouble Shooting	51
Specification	52
Optional Accessories	53
Announcement	54

Attention

- Please use this machine properly under the local regulation or law.
- Repairing or modification is only authorized to the professional technician legally.
- Please turn off this machine where is asked "Transceiver OFF" in order to avoid electromagnetic interference or electromagnetic compatibility, i.e. In Hospital or other medical care places, or on the airplane when it is asked by the steward.
- Don't put this machine where the SRS opening area in a car.
- Please turn off this machine when you are in the surrounding with ethylene or explosives.
- Don't keep transmission for long time to make machine getting too hot to scald people or breakage itself.
- Don't use the broken antenna for transmission, as touching it may cause minor burns to skin.
- Don't make machine exposed under sunshine or heating places.
- Please ensure 5mm away from the transceiver when it is transmitting.
- Please turn off power of machine immediately if there is smell or smog from it, and contact the local dealer for support.

Product Inspection

Thanks for selecting our DMR/Analogue Combined Radio KG-D901, please do the product inspection before use.

- whether the package is well packed without any breakage.
- please check the accessories inside the package.

Accessories list

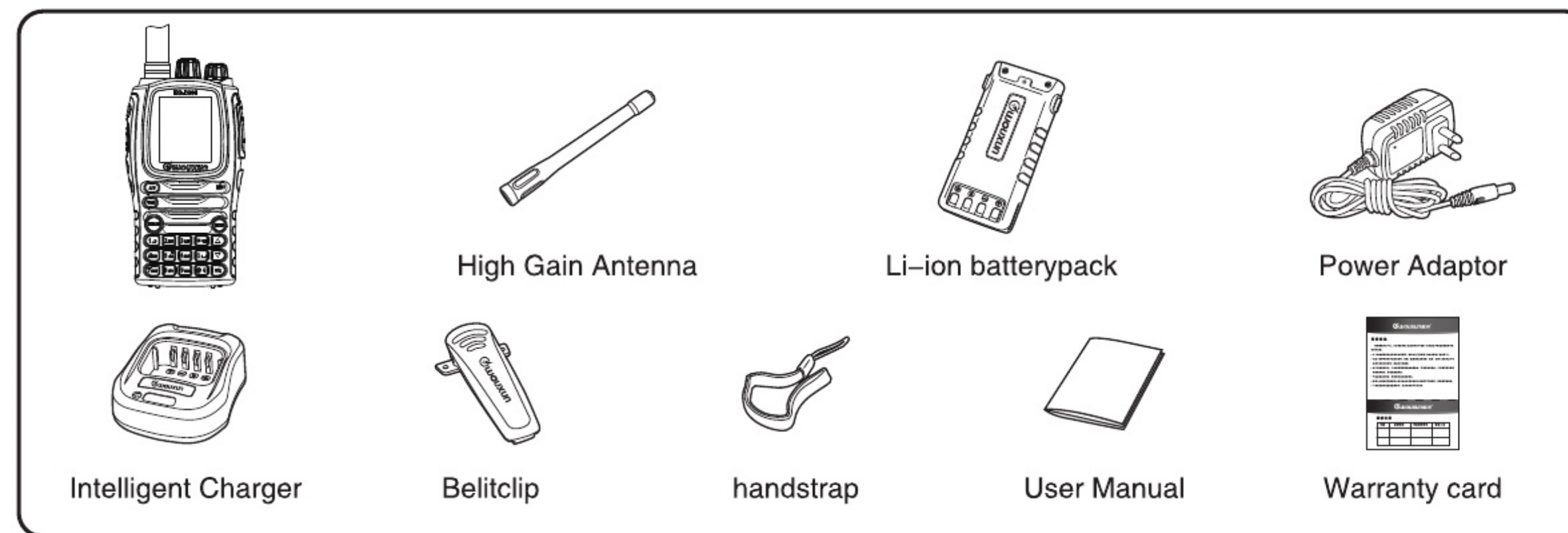

Battery Information

Attention to Charging

Please make the battery full charging before use it. Charging/discharging for two or three times will make the battery voltage the best status. Please recharge it or change a new battery when it is low voltage.

Reminder

Don't make the conductive metal like jewelry, key or decoration get close to the electrode of battery, it might get burnt or breakage when the conductive metal causes short circuit and high heat. Please be careful to pack the battery into the pocket, bags or other metal container.

Charging

Please study the indicators when charging the battery.

Indicator	Charging Status
Red LED	Being Charged
Green LED	Full Charged

Here are the charging steps.

- Plug the charging adapter into power supply.
- Put battery or transceiver with battery packed into the charging station.
- Make sure the battery is well contact with touch tablet of charger. It starts charging when the indicator of charger turns red.
- It takes four hours for charging. When the indicator turns green, battery is full charged. Please pull out the battery or transceiver with battery.

Care and Cleaning

- Use soft cloth to clean the dust and spot.
- Cover the microphone button when transceiver is not working.
- Use the neutral detergent to clean the buttons, knobs and plastic case of transceiver. Don't use the strong corrosion chronic chemicals and clamp cloth to clean it.

Accessory Installing

Battery Installation and Remove

The batterypack is not fully charged before leaving factory. Please charge it before use.

NOTE

- » Do not shortcircuit the terminals or put the batterypack into fire.
- » Do not try to remove the case from the batterypack.

1. Please aim the batterypack at the back of the transceiver, and then push up and press down the batterypack to lock the release latch. (See Picture 1)
2. If you want to remove the batterypack, push down the release latch, and the batterypack will be released from the transceiver. (See Picture 1)

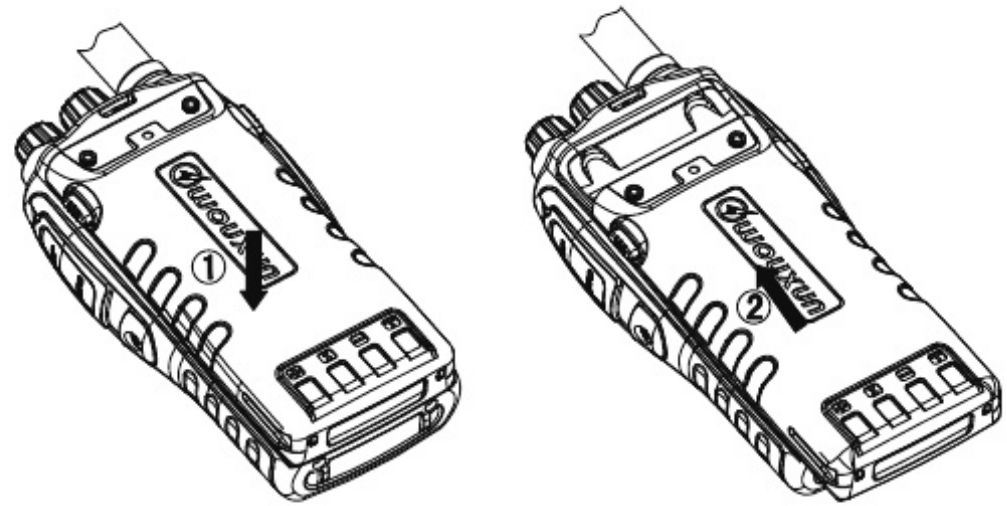

(Picture 1)

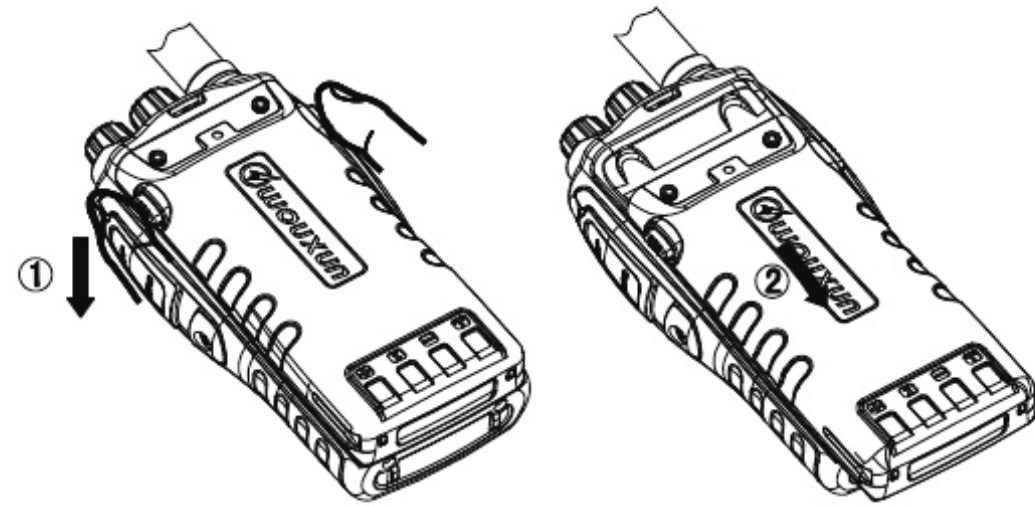

(Picture 2)

Accessory Installing

Antenna Installation and Remove

Hold the antenna connector, rotate the antenna by clockwise into mounting on the top of transceiver to make it tight. (See Picture 3)



(Picture 3)

Antenna Installation and Remove

Hold the antenna connector, rotate the antenna by anticlockwise off mounting. (See Picture 4)

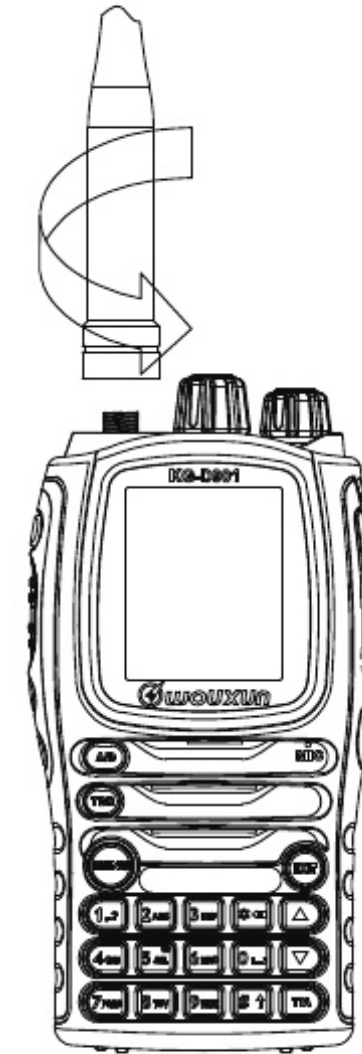

(Picture 4)

Accessory Installing

Beltclip Installation and Remove

Screw the beltclip onto the back of batterypack for easy use if needed. And just remove the two screws off the battery to take off the beltclip.

(See Picture 5)

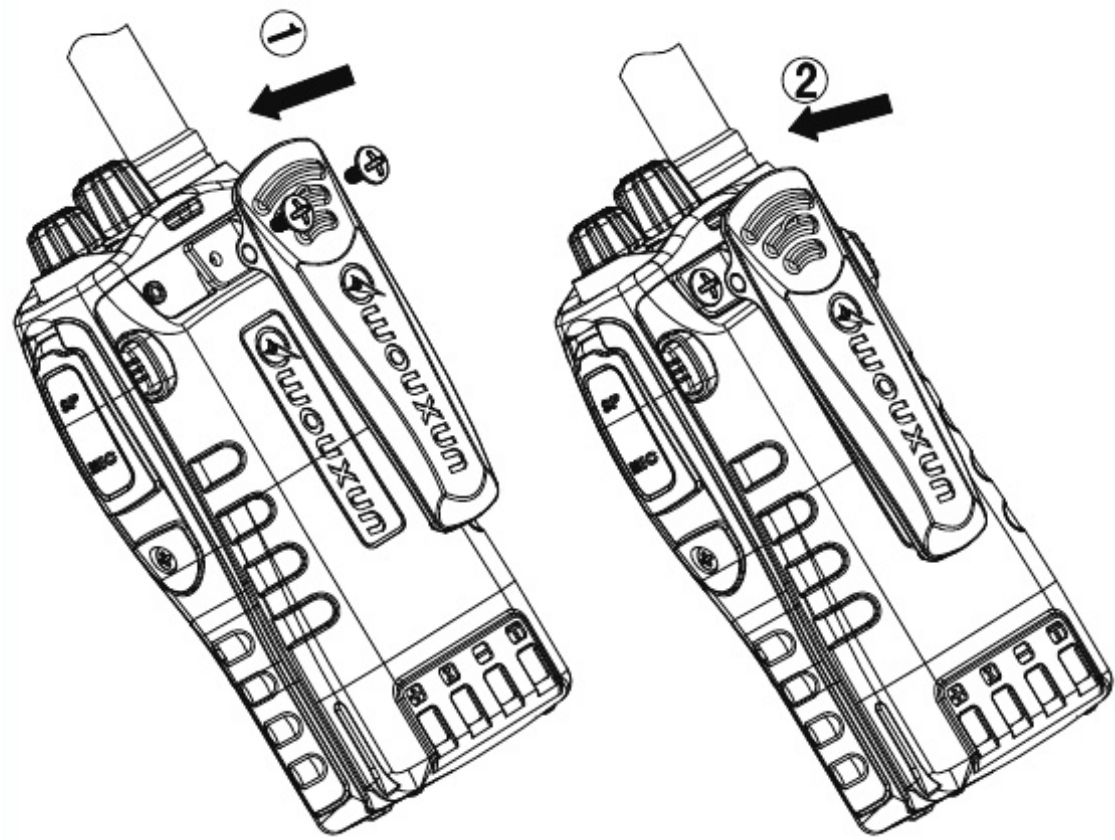

(Picture 5)

MIC/Speaker and Earphone Installation

Open the microphone cover, and plug the MIC/Speaker and Earphone into the microphone jack.

(See Picture 6)

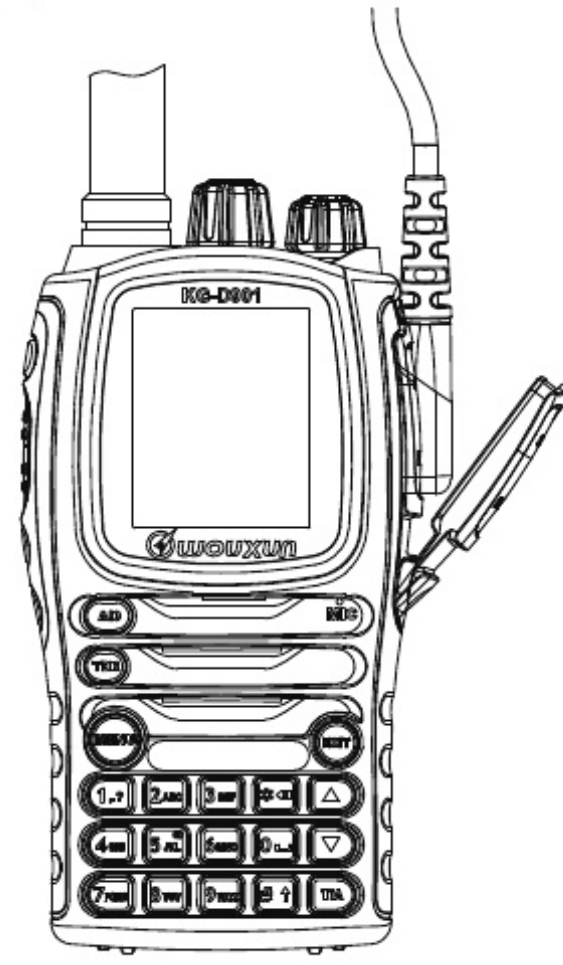

(Picture 6)

Accessory Installing

Handstrap Installation

Install the handstrap into the back hole of the transceiver. (See Picture 7)

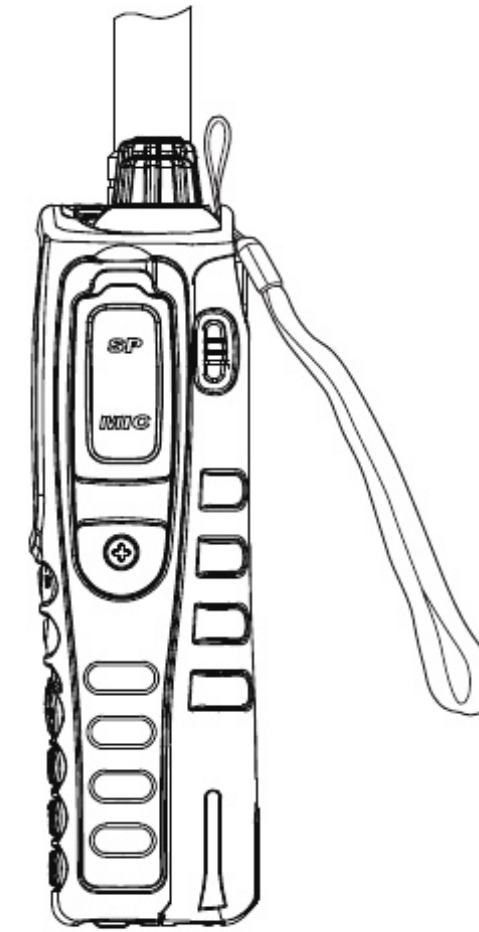

(Picture 7)

Digital Repeating Channel Setting

1. Program the receiving and transmitting frequencies for repeating. (Pls refer to Page 22 Program TX/RX Frequencies)
2. Program the color code for digital repeating. (Pls refer to Page 22 Program Color Code)
3. Program the time slot for local repeating. Default is Time Slot 1. (Pls refer to Page 41 Repeating Time Slot)
4. Please make the different IDs for these two repeating handheld. Pls go to the "Device Information" to view the "Basic Information" to see this information and use the software to program it accordingly. (Pls refer to Page 33 Radio ID Setting)
5. Please program the correct ID for transmitting contacts.
 Individual Call: Contact ID should be the same as local radio ID.
 Group Call: Group ID should be the same as the receiving group ID.
 All Call: It accepts any IDs.
 (Please refer to Page 43 Digital Contact& Receiving Group List)

Note:

After repeating channel is well programmed and press PTT to transmit. It display " BS Activate Overtime" if the range is too far to regularly connect and activate the repeater. Pls turn on the talkaround function and press shortcut T/A key to activate talkaround function if needed. Of course, talkaround function is also programmed as the sidekey by programming software ahead before you use it.

Learning Transceiver

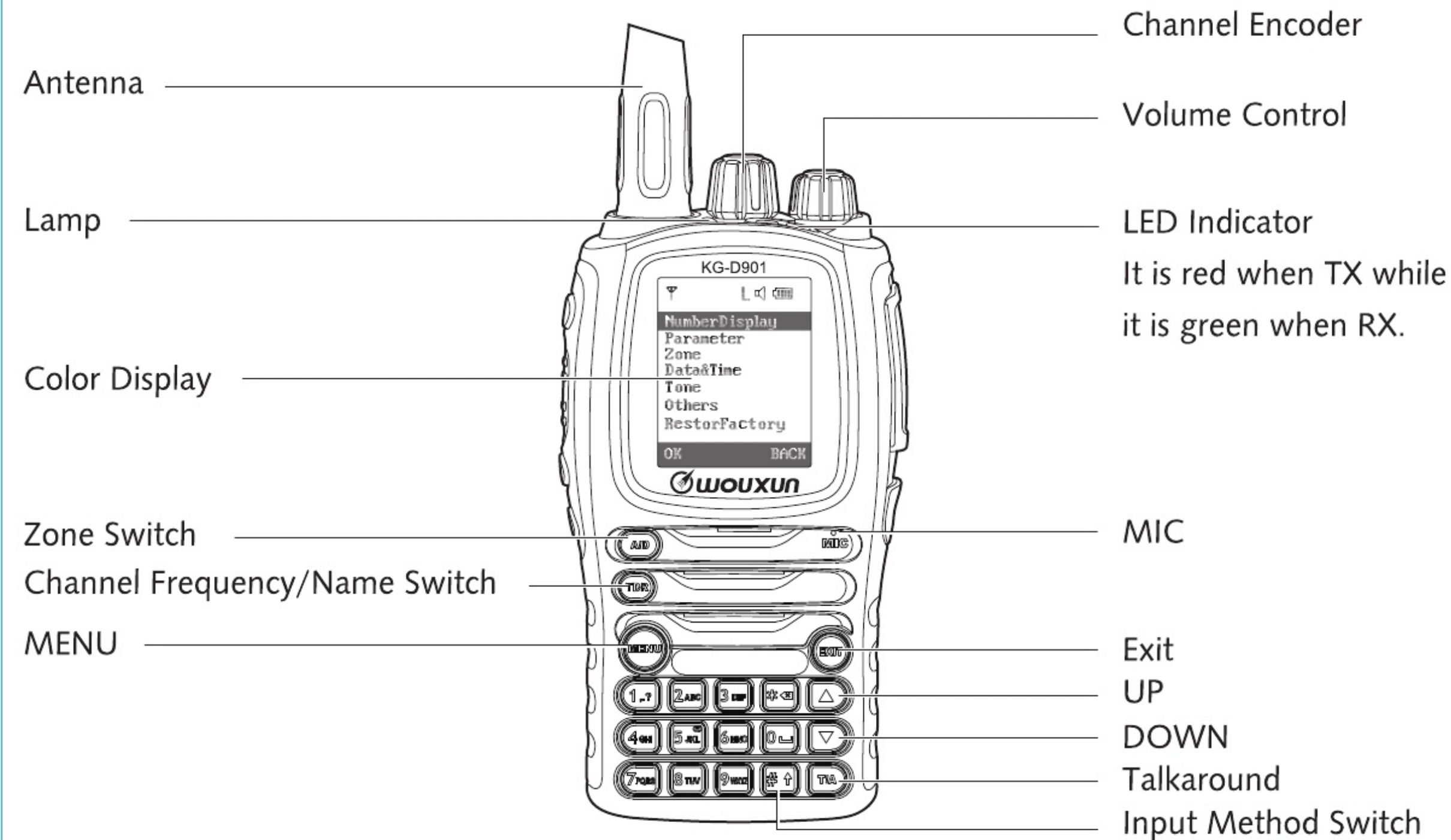

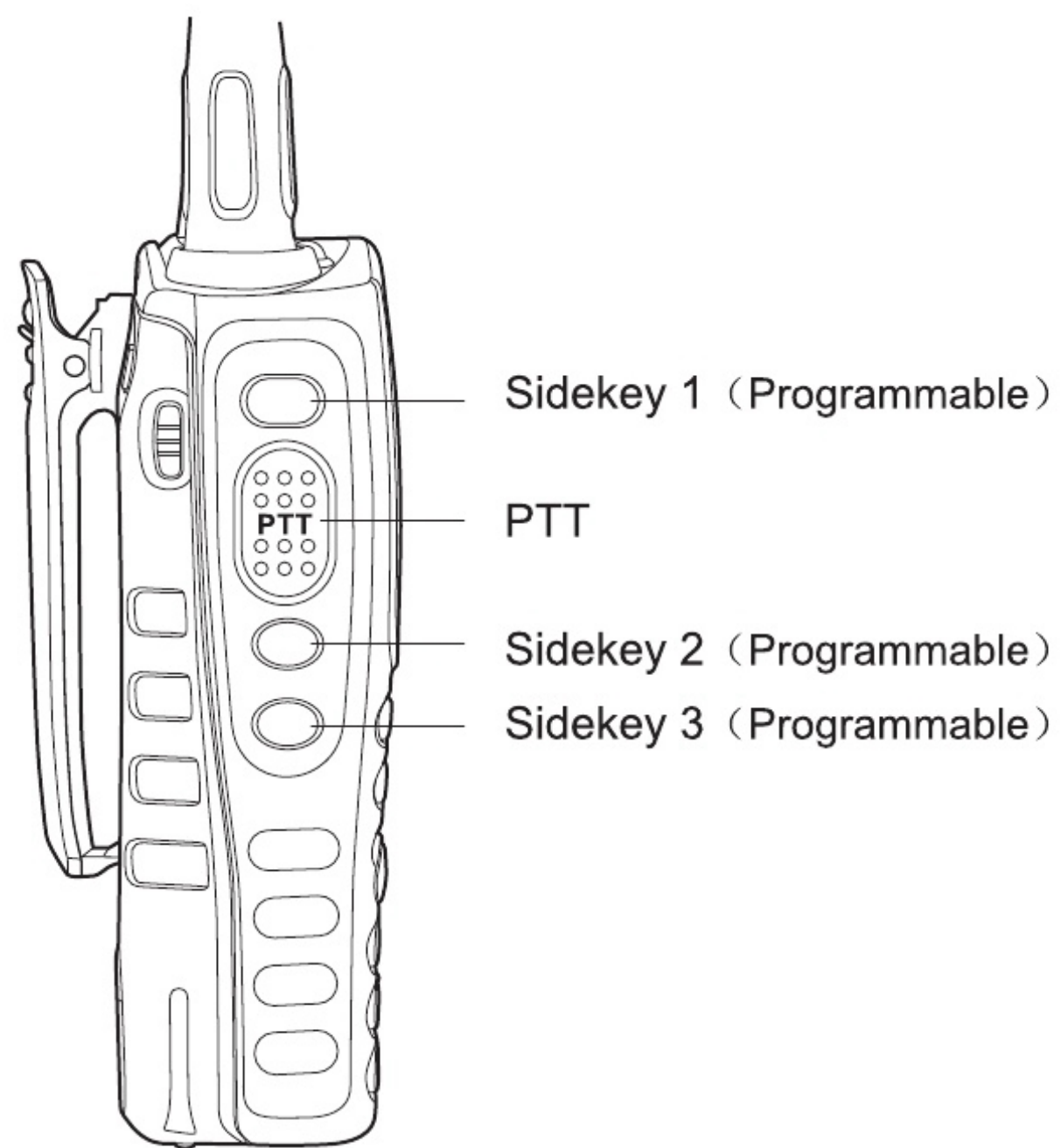

Here is the programmable functions list for sidekey 1 and sidekey 2(Long press and Short press)

- Radio Enable
- Radio Check
- Radio Disable
- High/Low Power Selection
- Monitor
- Emergency mode open
- Emergency mode close
- Digital/Analogue Mode Selection
- Scan ON/OFF
- VOX
- One Access 1
- One Access 2
- One Access 3
- One Access 4
- One Access 5
- Repeat/Talkaround
- Zone Selection
- Flashlight
- Alone Work

RADIO ENABLE

- When activate function is activated by programmed sidekey, transceiver sends the activate code to another radio which is killed and programmed by activate decoding to make it enable working again.

Note: This function is only available for digital channel. There is prompt for failed operation if working on analogue channel.

RADIO CHECK

- When checking function is activated by programmed sidekey, transceiver sends the checking code and start checking the decode of another radio.

Note: This function is only available for digital channel. There is prompt for failed operation if working on analogue channel.

Button Setting

RADIO DISABLE

- When kill function is activated by programmed sidekey, transceiver sends the kill code to another radio which is activated by kill decoding to make it disable working.

Note: This function is only available for digital channel. There is prompt for failed operation if working on analogue channel.

High/Low Power

- Press the side key to switch High/Low Power after this key is programmed as this function via programming software.

Monitor

- When monitor function is activated by programmed sidekey, there is squelch prompt. This function is checking whether the current channel is occupied or not, in order to remove CTCSS/DCS tone or receive the weak signals.

Note: This function is only available for analogue channel. There is prompt for failed operation if working on digital channel.

EMERGENCY MODE OPEN

- When emergency function is activated by programmed sidekey, transceiver can ask for help when emergency use.

Button Setting

Note: This function is only available for digital channel. There is prompt for failed operation if working on analogue channel.

EMERGENCY MODE CLOSE

- When emergency function is disable by programmed sidekey, transceiver stops the emergency function.

Note: This function is only available for digital channel. There is prompt for failed operation if working on analogue channel.

Zone Selection

- When this function is preprogrammed sidekey by software, user can select desired work mode directly by pressing the sidekey then.

Scan ON/OFF

- When scan function is activated by programmed sidekey, transceiver starts scanning from the current channel. LED is turned green and stop on the channel when receiving the compatible channel.
- Press the sidekey again to exit from scanning mode.

VOX

VOX on this transceiver is level programmable, range is from 1 to 5, default is 1. When specified channel is programmed VOX on, and sidekey is pre-programmed to VOX function, it is directly pressing sidekey to turn on or off VOX function.

Button Setting

One Access

There are sidekey1,2,3,4,5 programmable to one access function, and press the Push-to-Talk programmed sidekey to transmit.

Repeat/TALK AROUND

Sidekey is pre-programmed to Repeat or TALK AROUND function, and press sidekey to switch these two functions.

When transceiver disconnects from the repeater, and communication with other transceiver or similar groups, it is called talk around. The transmitting frequency is same as receiving frequency if talk around function is generated, and transmitting signalling is also identical with receiving signalling.

Flashlight

Sidekey is programmable to turn on or off lamp function.

Alone Work

The Alone Work alarms when there is no operation on the equipment within the pre-programmed time. Users program the Alone Work function on the specified channel ahead, there is alarm prompt on this radio if no operations on it exceeding the pre-programmed time.

LCD Screen

Interface for Idle, Call and Main Menu

Idle Interface

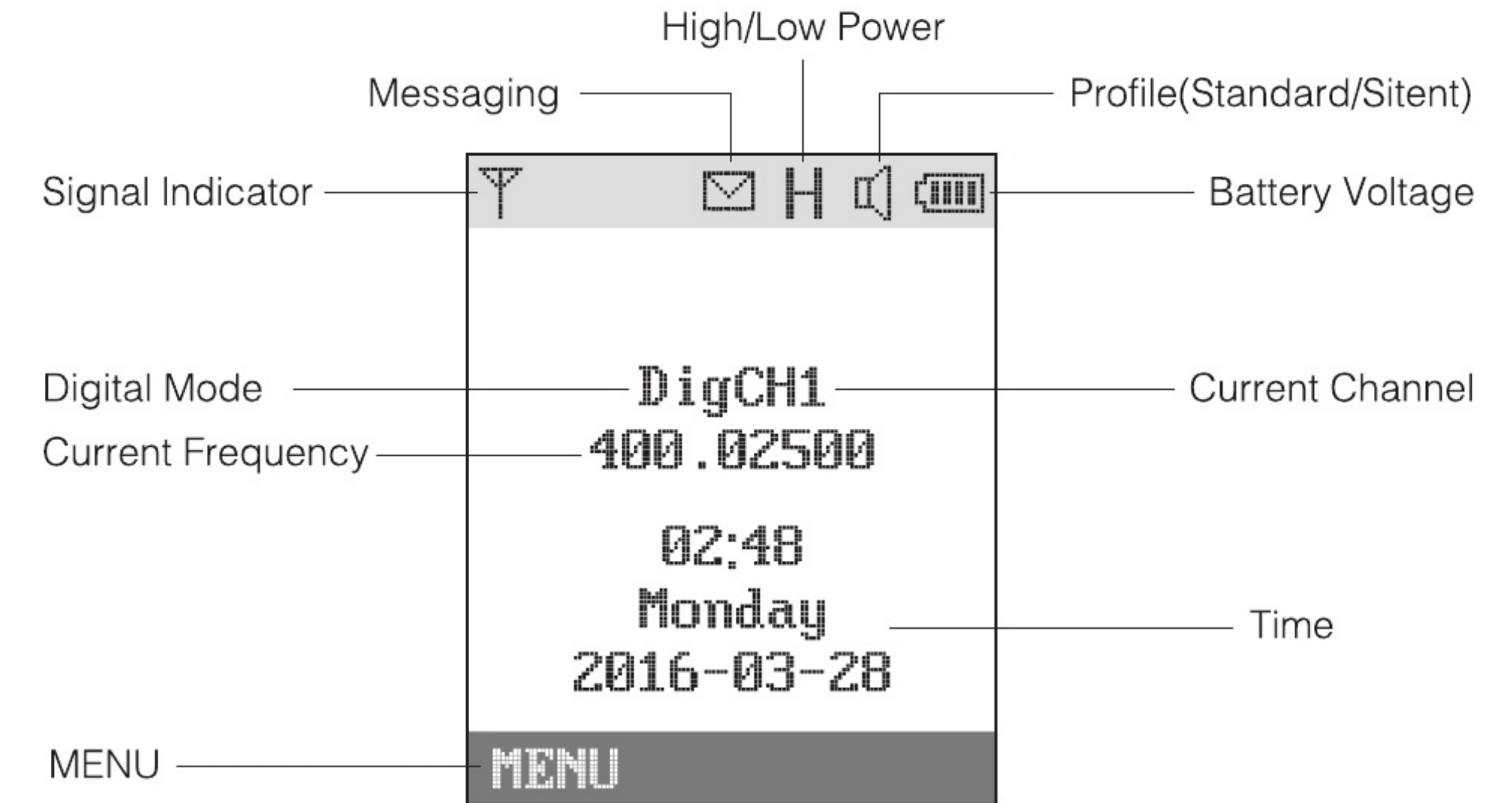

LCD Screen

Call interface

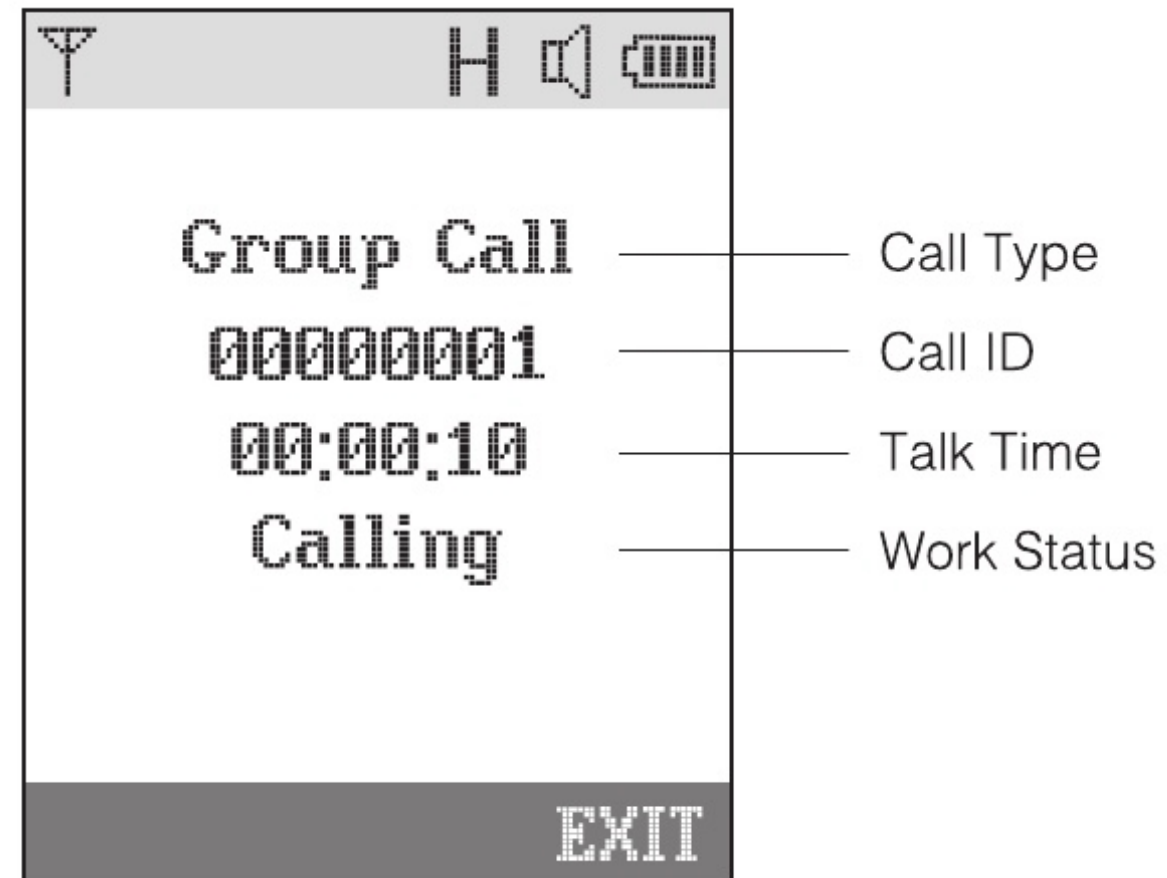

LED Indicator

The led indicator flashes red when transmitting.

The led indicator flashes green when receiving.

The indicator flashes green every 10s when standby.

The led indicator flashes red every 5s and there is tick prompt when it is low voltage and required re-charging.

Basic Operations

Turning ON/OFF Transceiver

Please rotate the volume encoder to turn on or off transceiver. Clockwise rotation is powering on transceiver, while anticlockwise is powering off the transceiver.

Channel Selection

Please rotate the channel encoder or press up/down key to select the channels for transceiver.

Volume Control

Please rotate the volume encoder to change the volume level for transceiver when it is powered on.

Transmitting

In digital mode, please program the digital channel for transmitting.

- A. Select the contact for call in the contact list firstly.
- B. The default contact is selected when press PTT to transmit in standby.
- C. Please use the compatible programming software to program the contact information if needed.

Receiving

There is signal intensity display when transceiver receives the RF signal. It transmits out the audio if receiving the individual call, group call or all call from a digital channel. It also transmits out the audio if receiving the calling from an analogue channel which is identical on QT/DQT tone.

Basic Operations

Respond to Call

Press PTT to respond back to the call within 5 seconds after receiving calling signal on the digital channel. It would respond to call the default contact if exceeding 5 seconds after receiving a signal calling on the digital channel.

Press PTT directly to transmit back after receiving calling signal on analogue channel.

Backlight

When radio receives, the backlight will be on automatically no matter in digital mode or analogue mode. The keep time for backlight is programmed by software.

Channel Edit

In Digital Mode

📶 H 🔊 🔋	
TX:400.02500	
RX:400.02500	
CC:01	
SAVE	BACK

In Analogue Mode

📶 H 🔊 🔋	
TX:400.02500	
RX:400.02500	
BW:25K	
R: Carry	T: Carry
SAVE	BACK

Channel Edit

In standby, press any numeric keys from 1 to 9 to enter into channel edit interface. Please press sidekey 2 and sidekey 3 to edit the parameter for channel. Press menu to save and exit from channel edit.

Program TX/RX frequencies

TX: In channel edit interface, select the TX frequency edit by sidekey 2 and sidekey 3 and then input the desired frequency directly.

RX: In channel edit interface, select the RX frequency edit by sidekey 2 and sidekey 3 and then input the desired frequency directly.

Program Color Code(Digital Mode)

Color code:In channel edit interface, select the Color Code edit by sidekey 2 and sidekey 3 and then select specified code from 0 to 15 by pressing up/down key.

Program Bandwidth(Analogue Mode)

Bandwidth:In channel edit interface, select the Bandwidth edit by sidekey 2 and sidekey 3 and then select specified bandwidth from 12.5K and 25K by pressing up/down key.

Program QT/DQT(Analogue Mode)

R: Carry means Receiving QT/DQT. In channel edit interface, select the Bandwidth edit by sidekey 2 and sidekey 3 and then select specified tone from CTCSS, DCS, and InvDCS by pressing up/down key.

Channel Edit

After selecting the tone by sidekey 2 or sidekey 3, then choose the desired tone value by up/down key.

T: Carry means Transmitting. In channel edit interface, select the Bandwidth edit by sidekey 2 and sidekey 3 and then select specified tone from CTCSS, DCS, and InvDCS by pressing up/down key. After selecting the tone by sidekey 2 or sidekey 3, then choose the desired tone value by up/down key.

Menu

Menu in digital mode

Main Menu Interface



Text Messaging

- A. Inbox
- B. CreateMsg
- C. Outbox
- D. CommMsg
- E. DelMsg



Menu

Inbox(Msg list)

CreateMsg(Py, 12, ab, AB)

Outbox

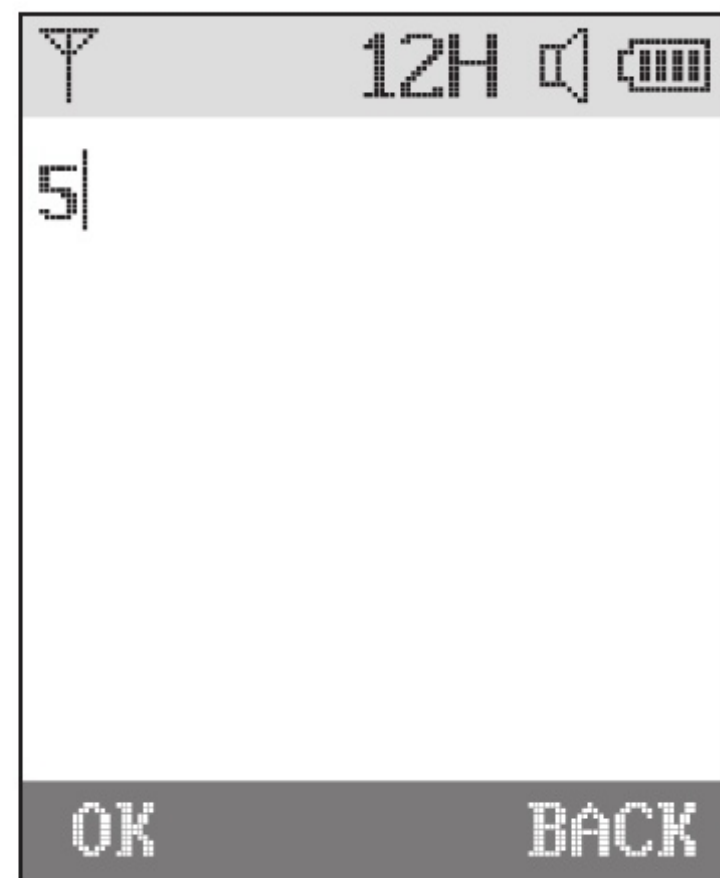

Menu

CommMsg

DelMsg

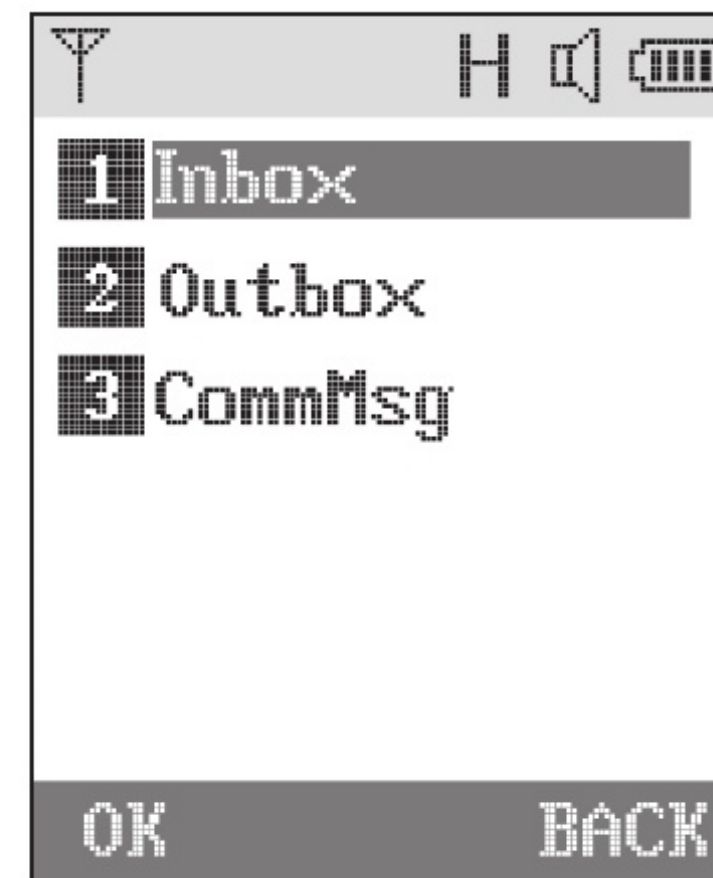

Menu

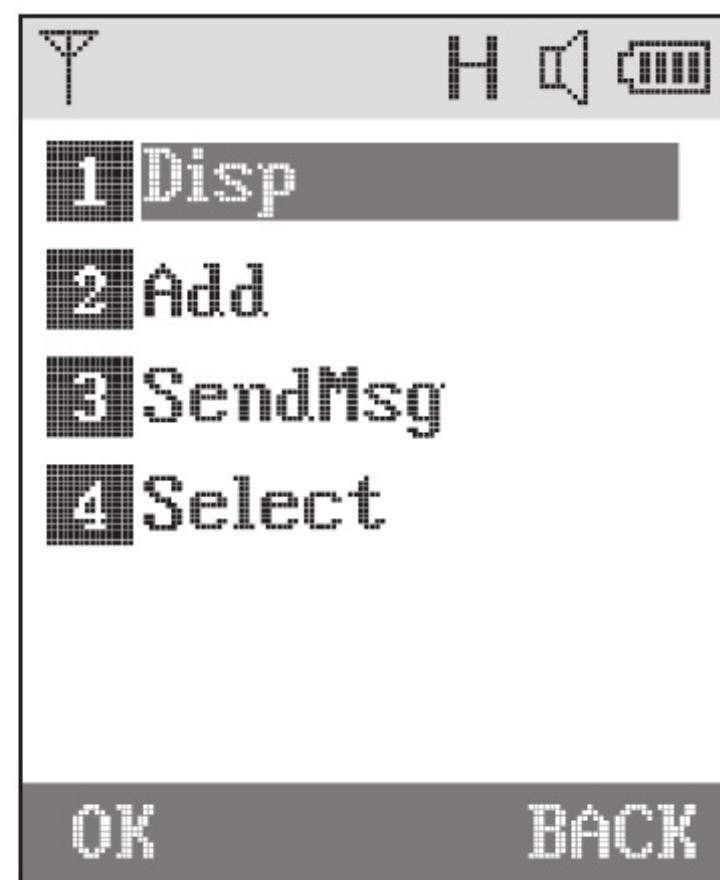

Settings → Local
Parameter
Zone
Data & Time
Tone
Others
Side key
Default

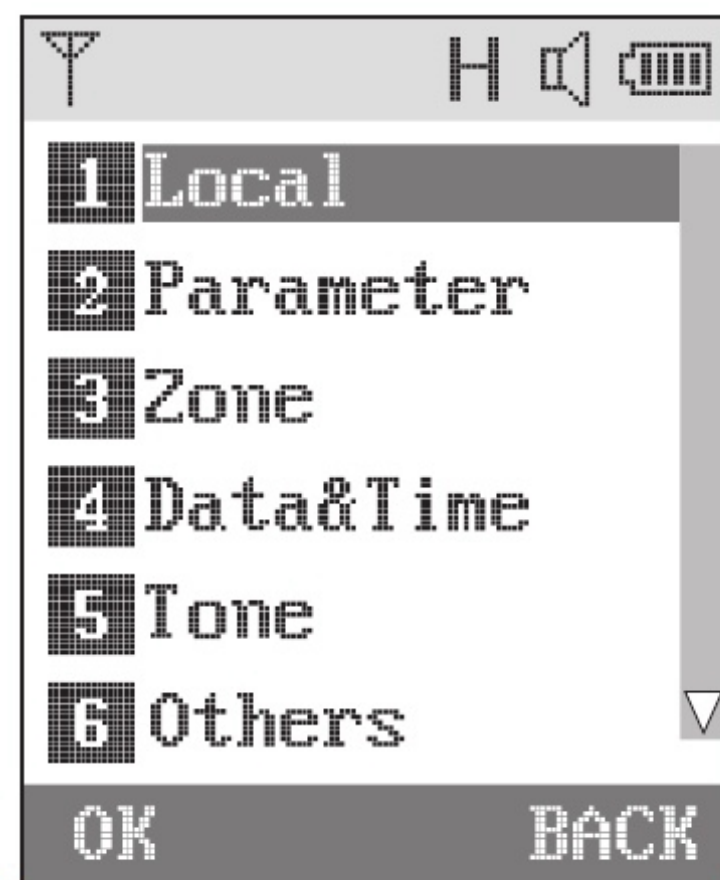

Menu

1、Local → Serial Number

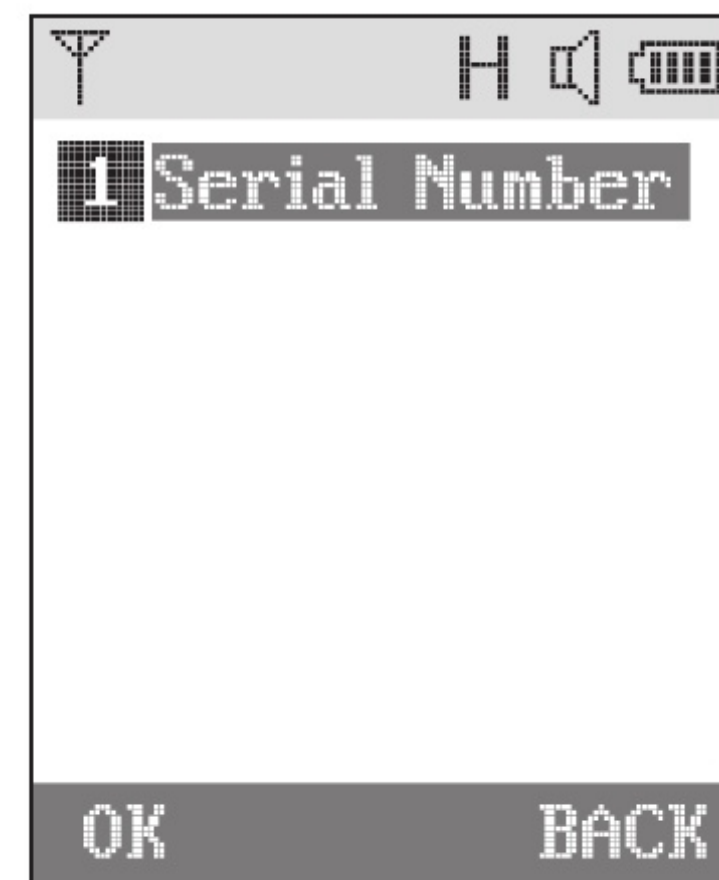

2、Parameter → Call Time
Power
Slot

- a. Call Time → The time of communication(s)
(Up or Down key adjust 10s/step)
- b. Power → High Power
Low Power
- c. Slot → Slot1
Slot2

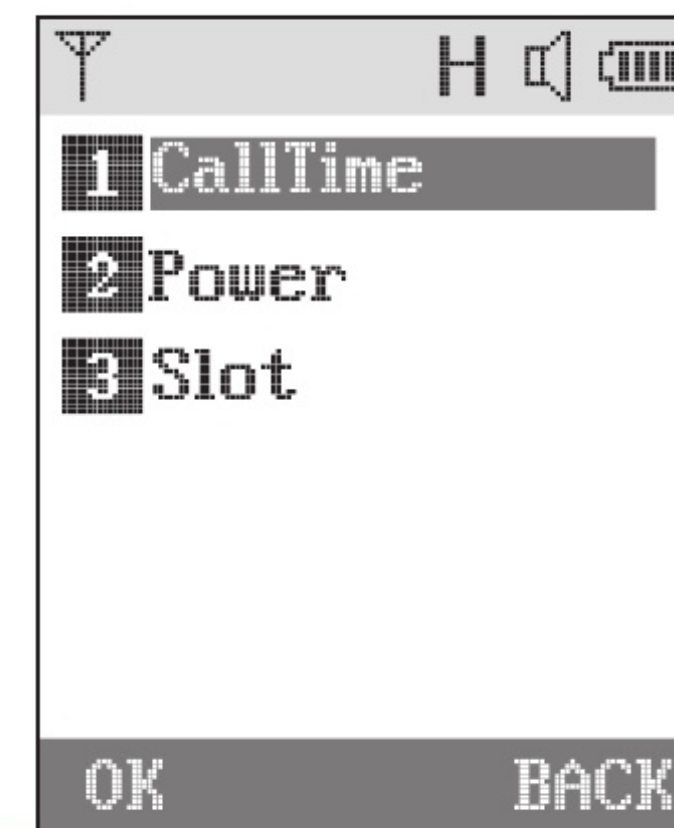

Menu

- 3、 Zone → Zone 1
Zone 2

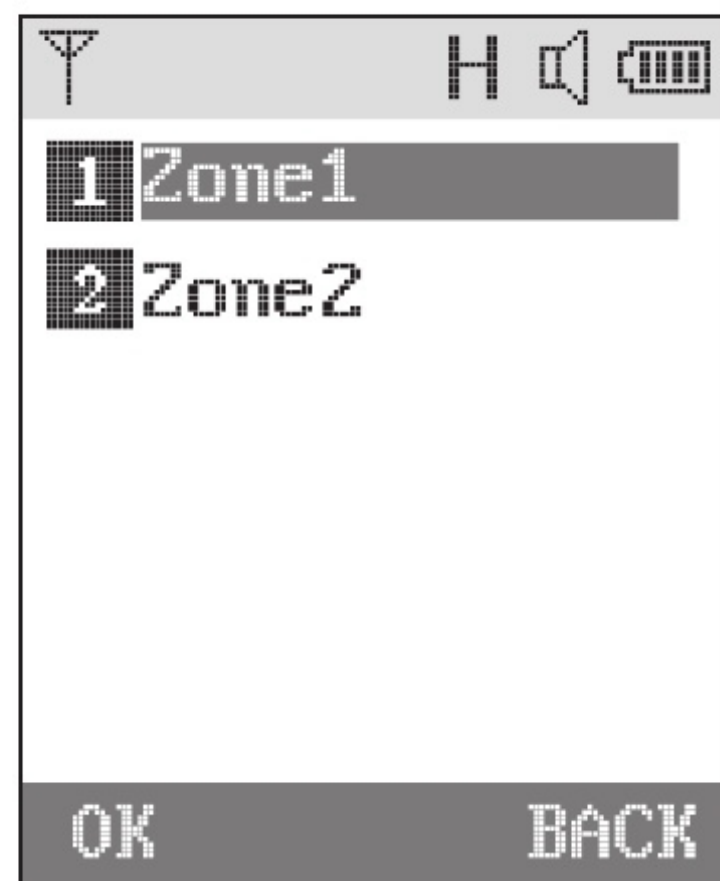

- 4、 Data& Time → Data
Time
Week
DateForm → Y/M/D
M/D/Y
D/M/Y



Menu

- 5、 TONE → Profiles
Keypadset
Power Tone
Msg Tones
- a. Profiles → General
Silent
- b. KeyPad set → KeyRingSw → Key Ring On
Key Ring off
KeyRingStat → 0-13(UP or Down adjust)
- c. Power Tone → ToneSw → CouloToneOn
CouloToneOff
ToneStat → 0-13(UP or Down adjust)
- d. MsgTones → Ring 1
Ring 2
Ring 3
Ring 4
Ring 5



Menu

- 6、Others → a. Language → Chinese
English
b. LockKey → TurnOff
TurnOn
c. Led → keep light
5 sec
15 sec
30 sec
e. Version → Ver. 16.05.25



7、Side Key

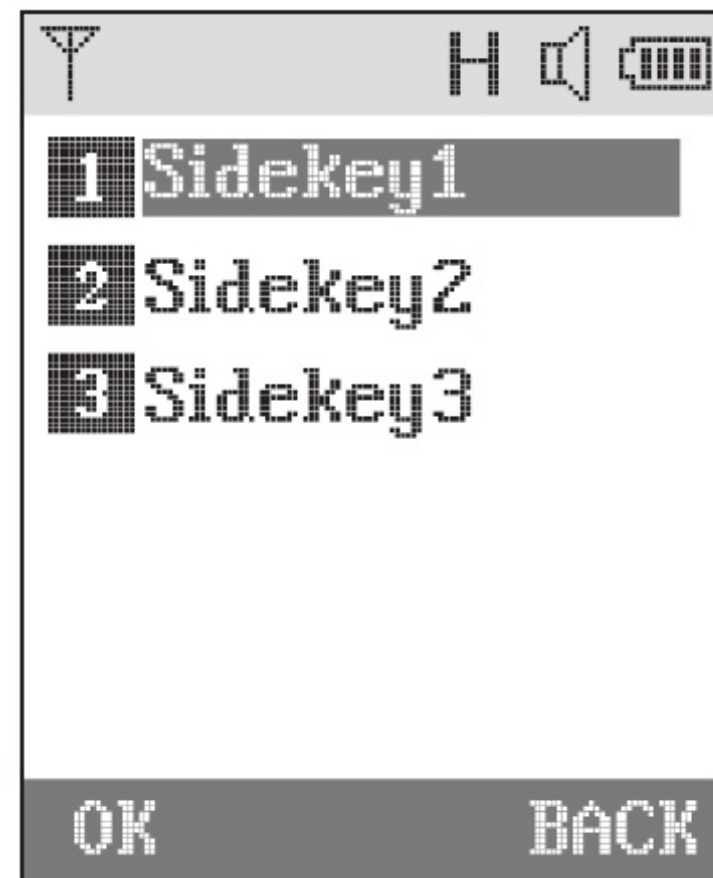

Menu

8、Default

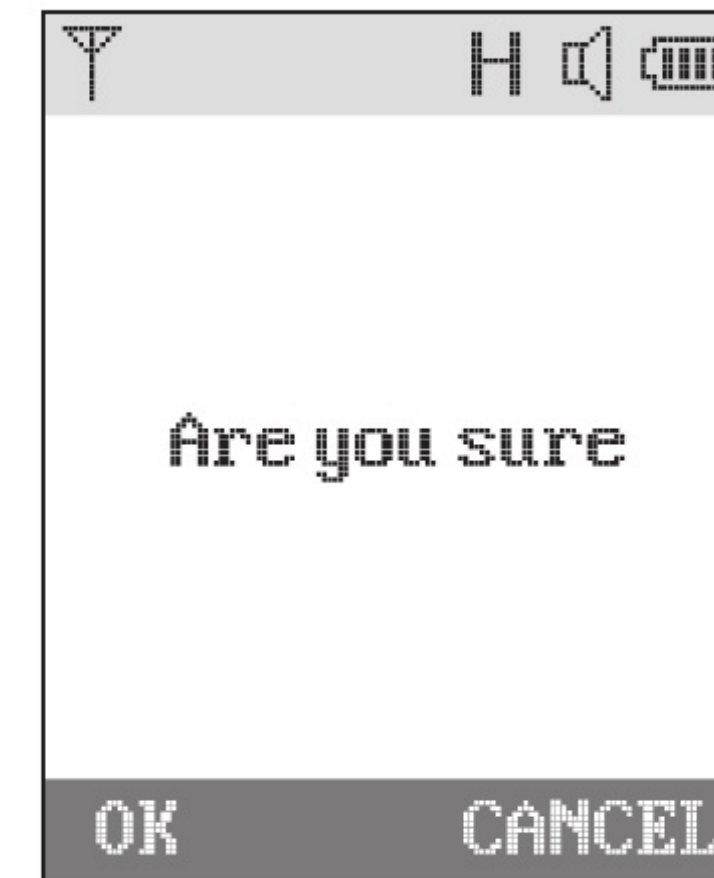

Menu on Analogue mode

There is only "Setting" under menu list in the analogue mode. Please refer to the settings of the menu list in digital mode.

Radio ID Settings

User can specify an ID for identify from calls or messages by other users. The value range selectable is from 1 to 16776415. Only digital mode supports this function.

PS: This function is only editable by programming software. Please view the ID number from “Basic Setting” - “Basic Setting” - “Radio ID”.

Record

Our radio supports voice record, selectable for Record Receive Only, Record Transmit only, Record Receive and Transmit enable, Record Receive and Transmit disable.

PS: The longest record time is 20 mins. The maximum is 20 pieces of record. The No.1 record will be loop deleted when the records is full.

The record function only be supported in Digital Mode.

Text Message

Our radio supports text messaging, and it can be edited maximum 340 English words or 170 Chinese words each.

Inbox

This radio can store messages received. It prompts “Message receive” and “” will be showed on top

of screen.

When receiving the message, the stand-by screen will show.

There are 20 received messages can be stored. When the Inbox is full, the earliest messages will be covered by new messages automatically.

Outbox

This radio can store the created message or sent messages. The maximum is 20 messages.

When the Outbox is full, the earliest messages will be covered by new messages automatically.

You can review, create, insert common messages, sending and delete for the any message on Inbox and Outbox.

You can review, edit, insert common messages in one touch access, send and delect for text message funciton on this radio.

If you need completely delect the information in the inbox or outbox, please select “Text Mesage” → “Delect”.

Short Message (CommMsg)

There are somecommon messages which is pre-edited ahead by dealers for you to use or edit quickly.

It can be edited maximum 39 English words or 19 Chinese words.

PS: It can be edited manually or by PC programming.

Functions and Operations

One Touch Access

This function is editing the common messages and programming the specified contact for call to shortcut operation, including the settings for work mode (digital or analogue), Call Type, Call or Message, Text Message(pre-edited common message if selecting message). This is generated by pre-programmed key 1,2,3,4 and 5 atmost.

PS: Only can be set by programming software.

Keypad Lockout

The users can set Auto Keypad Lock via menu. The keypad will be automatically locked without any operation exceeding 10seconds.

After the keypad is locked, when receiving signals, the keypad will be unlocked automatically, and will be locked again without any operation exceeding 10seconds.

Remind: This function only can be programmed via Menu.

Transmission Overtime Forbidden (TOT)

Transmission overtime forbidden means when one transmission time exceeds the allowed period, the transmission is forcibly stopped in order to prevent the current channel is occupied by some user for a long time.

Functions and Operations

Option: 30-500 Seconds

Remind: This function can be programmed via both menu and programming software.

Language Setting

This model includes English and Chinese as display and voice guide languages. The language can be selected via Menu or Programming software.

Power Saving

The save power mode can be selected via programming software.

Power Saving Start Timeout

When there is no operation or transmission/receiving, the radio will enter save power mode. The option for start time is 10-60seconds.

Remind: This function only can be programmed via programming software.

Squelch

Squelch function is to avoid the radio from the noise or unrelated signal's interfere. The squelch level can be selected from 1 to 9. The higher squelch level, the stronger receiving signal is needed.

Functions and Operations

VOX

VOX level can be selected from 1 to 5. High level, more sensitive VOX.

Remind: Only can be programmed via supplied programming software/

Please follow the below steps to open VOX:

1. Set VOX level as desired.
2. Open VOX function on the desired channel (Via programming software).
3. Program the side key 1,2 or 3 as VOX function.

After finishing the setting, press the side key to activate the VOX function, and press the side key again to inactivate the VOX function.

Key Tone

Key tone can be set from 1 to 13 levels. Higher level, louder key tone.

Remind: This function can be programmed via Menu or Programming Software.

Battery Tone

Battery Tone can be set from 1 to 113 levels. Higher level, louder prompt.

Remind: This function can be programmed via Menu or Programming Software.

Functions and Operations

Zone

The radio includes 64 zones, and each zone has 1024 channels. One zone can be made up of analogue or digital channels. Zone A and Zone B can be switched via side key or switch key.

It is supported to have 8 characters as maximum to edit the zone name.

Channel Name

The channel name can be edited by 8 characters as maximum.

Remind: Channel name can be edited only via programming software.

Scan

Program the side key as "Scan", and press this side key to activate scan function.

Open "Automatic Start Scanning", when the radio switches to this channel, scan function is activated.

Remind: This function only can be programmed via Programming Software.

Scan List

Associate one channel list to the current channel, all channels on the list will be detected when the current channel starts scanning.

There are 16 channel lists that can be programmed via programming software. Channels can be added to scan lists freely from Zone A and Zone B.

Functions and Operations

Remind: This function only can be programmed via Programming Software.

TX Reply Channel

In scanning, press PTT key to transmit from the channel that is for transmission.

The last active channel: In scanning, press PTT to transmit on the channel that was received the signal. (If there was no signal that was scanned last time, it will transmit on the current channel).

Fixed Channel: Select one channel from Zone A or Zone B as the transmission channel.

Selected Channel: The current channel will be transmitted when pressing PTT key after starting scanning.

Remind: This function only can be programmed via supplied programming software.

Residence Time

After scanning channels, the time for staying at the channel. It can be selected from 0.5Seconds to 10seconds.

Remind: This function only can be programmed via supplied programming software.

TX Residence Time

In scan mode, the time for re-scanning when staying the channel after pressing PTT key. It can be selected from 0.5seconds to 5seconds.

Remind: This function only can be programmed via supplied programming software.

Functions and Operations

Dual Priority Channel Scan

When there is a priority channel on the scan list, the priority scan mode will start. Any channel is scanned after scanning the priority channel each time.

For example, there are channel 1,2,3,4,5,6 on the scan list, only set channel 2 as priority channel, the scan order is Channel 2--Channel 1--Channel 2--Channel 3--Channel 2--Channel 4--Channel 2--Channel 5--Channel 2--Channel 6

Or if Channel 1 as priority channel 1, and channel 2 as priority channel 2, the scan order is Channel 1--Channel 3--Channel 2--Channel 4--Channel 1--Channel 5--Channel 2--Channel 6.

This function is programmed via supplied programming software. Priority mode 1&2 can start dual priority scan.

Priority Mode 1

NO (No start Priority Mode 1)

Fixed (Select one channel from Zone A or Zone B as priority channel under priority mode 1).

Selected (When starting scan, the current channel as the priority under priority mode 1).

Priority Mode 2

NO (No start Priority Mode 2)

Functions and Operations

Fixed (Select one channel from Zone A or Zone B as priority channel under priority mode 2).

Selected (When starting scan, the current channel as the priority under priority mode 2).

Remind: This function only can be programmed via supplied programming software.

Color Code Setting

Color code is a sign of a system, the radios are in the same communication groups require the same color code. If a channel with a different color code, the radio can not react accordingly. Since the radio regards this channel that belongs to another communication system. But if the radio will monitor the communication systems (set different color codes on several channels), the scan function can be started, then the radio can monitor the different communication systems.

Remind: This function can be programmed via MENU or supplied programming software.

Repeater Time Slot

DMR mode uses TDMA technology, which split a channel whose bandwidth is 12.5KHz into two alternate time slots. The users can select any time slot to communicate and data transmission.

Time Slot 1: In repeater mode, the radio always use time slot 1 to transmit and receive. In direct communication, the setting is invalid. During direct communication with repeater signal, the radio use time slot 1. When pressing PTT key, the radio always use time slot 1 for transmitting (only valid for repeater).

Functions and Operations

Time Slot 2: In repeater mode, the radio always use time slot 2 to transmit and receive. In direct communication, the setting is invalid. During direct communication with repeater signal, the radio use time slot 2. When pressing PTT key, the radio always use time slot 2 for transmitting (only valid for repeater).

Remind: This function can be programmed via Menu or supplied programming software.

Emergency System

The radio sidekey can be programmed as "Emergency Start", to start SOS alarm function. The "Emergency Alarm Indication" should be clicked for receiving, and "Emergency System" should be selected as "Sys1" for transmitting on the same channel.

Remind: This function only can be programmed via supplied programming software.

Access Politics

Impolite: Press PTT key to transmit.

Polite to CC: When the color code is not matched, press PTT key but can not transmit.

Polite to All: When the channel is not occupied, press PTT key to transmit.

Remind: This function only can be programmed via supplied programming software.

Private Call Setting

PATCS: Directly send audio to the specific contact without answering.

OACSU: Need answering from the specific contact before sending audio.

Remind: This function can be programmed via Menu or Supplied programming software.

Digit Contact

The users can build digit contact names, ID and type. There are 1024 contacts as maximum. IDs and names among the 1024 contacts should be different.

Edit: Re-edit the IDs, names and types for the contacts.

Add: Add the contacts.

Delete: Delete the contacts.

Select: Select this contact for communication on the current channel.

Remind: This function can be programmed via Menu or supplied Programming Software.

It is supported to have 8 characters as maximum to edit the contact name.

Receiving Group List

Associate a group list into the current channel. When detecting the matched call from the group list, the radio will open the speaker to get the audio. One channel can add 250 group lists as maximum.

Remind: This function only can be programmed via supplied programming software.

Digit Encryption

Scrambler the communication.

Freely select one group from 1-16 group as the scrambler group for the current channel. One group can freely 1-8 digits from 0-F(hex) for scrambling.

The two radios should be with the same scrambler data for communication.

Remind: This function only can be programmed via Supplied Programming Software.

Talk Around

Press the side key that is programmed as repeater/talk around to switch repeater or talk around function.

Talk around: When the radio is out of repeater, communication is with the radio or the related group.

When using talk around function, the transmission frequency is the same with the receiving frequency, and transmission signaling is also the same with receiving signaling.

Shortcut key "T/A" can switch repeater/talk around function. Talk around should be selected on the channel.

Disable, Enable, Check

Disable:

Press the side key that is programmed as disable function to transmit code to disable the radio that is activated disable decode.

Functions and Operations

Enable:

Press the side key that is programmed as enable function to transmit code to enable the radio that is activated enable decode.

Check:

Press the side key that is programmed as check function to transmit code to check the radio that is activated check decode.

Disable, enable and check functions are only valid for private calls, can not be activated for group calls and all calls.

Also can select the application function of the contacts on private call to check, prompt, monitor, disable and enable via menu.

DMR Basic Setting

Call last Time: 0-600ms

The time of lasting call mode after the call is ended.

Enable Wait Time: 130ms-1000ms

After transmitting enable code for the repeater, the time of the wait for the synchronous signals from the repeater. If the time is expired but not receive the signals from the repeater, the radio will transmit the signaling again to enable the repeater.

Functions and Operations

Enable Times: 1-10

The function is for programming times for activating the repeater. The radio transmit the code to enable the repeater, if the wait time is expired, the radio still does not receive the signals from the repeater, it will re-transmit the enable signaling. If the re-transmit times are expired, the repeater is still not enabled, enabling repeater is failed.

Bellwether Number: 0-63

Bellwether package means loading the information before data or control information (Text, Private Call etc.) Bellwether package increases the probability for checking message of the receiver. Bellwether numbers will occupy the channel resource. Users can program the numbers according to need and work mode.

Disable Code: When the radio receives disable code, the transmission/receiving is forbidden. Activating disable decode and receiving signaling, the radio will be disabled.

Enable Code: When the radio is in disable mode, the radio will activate enable decode after receiving code. And the radio will be enable after receiving signals.

Check decode: When receiving the check order, Radio A will send the status to Radio B. Radio A activate check decode, and will be checked after receiving check signal.

Remind: This function only can be programmed via supplied programming software.

Functions and Operations

DTMF Signaling Setting (Analogue Mode)

DTMF signaling is programmed only via supplied programming software. And this function is only available in analogue mode.

DTMF Encode sequence: There are 16 groups encode sequence group as maximum. Each group can be programmed 16 digits DTMF codes as maximum.

DTMF System: There are 4 systems as maximum.

Side Tone: means if the speaker open DTMF tone when the radio transmits DTMF code.

Preset Time: means how long the radio transmits DTMF code after pressing PTT key. The option is from 0ms-1000ms, each 10ms per level.

Single Code Last Time: The time of transmitting single DTMF code. The option is from 30ms-1900ms, each 10ms per level.

Code Space Time: The stop time for transmitting 1st code and 2nd code. The option is from 30ms-1900ms, each 10ms per level.

Reset Time: When DTMF ends transmission, the time of the radio waits for resuming. The option is 0.2s to 33s, each 0.2s per level.

PTT Encode Templates: Add 32 groups templates as maximum.

DTMF System: Freely select one from 4 systems.

Functions and Operations

Transmission Code via PTT: Begin transmission, press PTT and send DTMF encode at the same time.

End Transmission: Transmitting encode when releasing PTT key.

Both: Transmitting DTMF encode when pressing or releasing PTT key.

Connect PTT Code Template: Freely select one from DTMF encode 16 sequence groups, as the transmission encode group after pressing PTT key.

Disconnect PTT Code Template: Freely select one from DTMF encode 16 sequence groups, as the transmission encode group after releasing PTT key.

After following the above steps for setting DTMF signaling, the radio can add PTT template freely into any analogue channel, so that the analogue channel can transmit DTMF encode according to the setting.

Remind: This function only can be programmed via supplied programming software.

PC Programming Password

In order to make the programmed data confidential, the radio provides password function.

The password can be set for read/write data. The password is made up 6 numbers as maximum.

Write password and read password should be clicked via programming software.

Frequency Sheet

CTCSS Standard List

1-62.5	14-100.0	27-156.7	40-196.6
2-67.0	15-103.5	28-159.8	41-199.5
3-69.3	16-107.2	29-162.2	42-203.5
4-71.9	17-110.9	30-165.5	43-206.5
5-74.4	18-114.8	31-167.9	44-210.7
6-77.0	19-118.8	32-171.3	45-218.1
7-79.7	20-123.0	33-173.8	46-225.7
8-82.5	21-127.3	34-177.3	47-229.1
9-85.4	22-131.8	35-179.9	48-233.6
10-88.5	23-136.5	36-183.5	49-241.8
11-91.5	24-141.3	37-186.2	50-250.3
12-94.8	25-146.2	38-189.9	51-254.1
13-97.4	26-151.4	39-192.8	

Frequency Sheet

DCS Standard List

023	072	143	226	306	411	503	631	734
025	073	152	243	311	412	506	632	743
026	074	155	244	315	413	516	654	754
031	114	156	245	331	423	532	662	
032	115	162	251	343	431	546	664	
043	116	165	255	346	432	565	703	
047	125	172	261	351	445	606	712	
051	131	174	263	364	464	612	723	
054	132	205	265	365	465	624	731	
071	134	223	271	371	466	627	732	

Trouble shooting

Please check carefully if your transceiver is faulty by following this chart.

If you maintain to have trouble you can reset your transceiver, which will help you eliminate your problem very often.

Problem	Possible Cause	Possible Solution
Transceiver will not be powered on.	<ol style="list-style-type: none">1. The batterypack is not installed properly.2. The batterypack maybe exhausted.3. The batterypack is broken.	<ol style="list-style-type: none">1. Re-install the batterypack.2. Charge the batterypack.3. Change the batterypack.
The receiver light is on and there is no sound from the speaker.	<ol style="list-style-type: none">1. The power switch is not adjusted well.2. Confirm if you use the right mute mode.	<ol style="list-style-type: none">1. Turn the volume control again.2. Reset the mute mode.
Keys are out of work	<ol style="list-style-type: none">1. Keyboard is locked.2. Button is stuck.	<ol style="list-style-type: none">1. Unlock the keyboard2. Fix the stuck button.

Specification Sheet

Frequency Range	136-174MHZ, 350-390MHZ, 400-470MHZ
Working Temperature	-20°C ~+50°C
Memory Channel	1024
Channel Spacing	12.5KHz / 25KHz
Voltage (DC)	7.2V DC
Size (without antenna)	124.4×61.49×33.88 (mm)
Weight (including batterypack)	490g
Output Power	>4W
Audio Distortion	≤5%
Frequency Deviation	≤5KHz
Spurious Radiation	≤7.5uW
Sensitivity	≤-120dbm
Audio Output	≥500mW
Modulation Distortion	≤10%

Optional Accessories

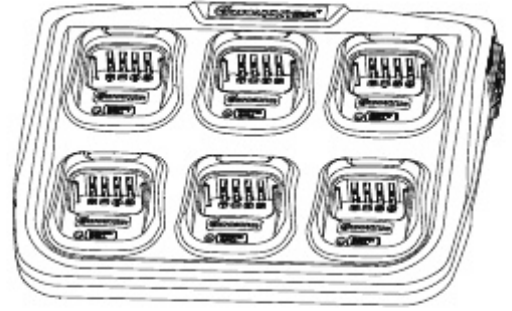

Six way charger

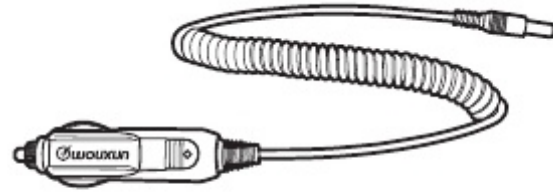

Car Charger



Programming Software



Eliminator

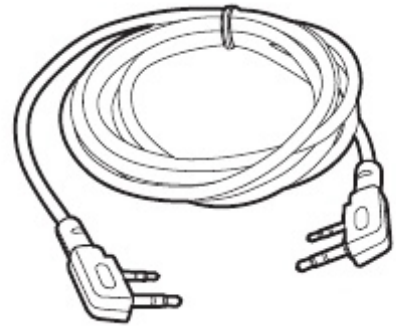

Wire-clone cable

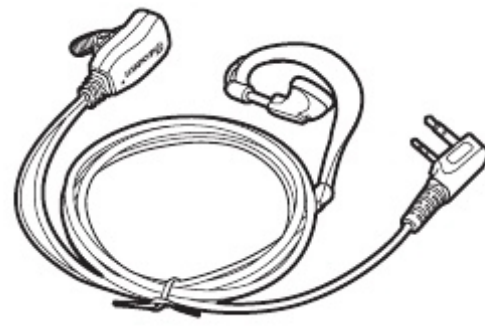

Headset



MIC/Speaker

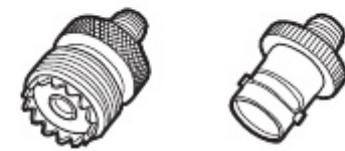

(SL16) (BNC)

Antenna Adapter

Announcement

We are working hardest to make the manual perfect, but there is still emission and printing errors. All the above specification is subject to updated by  without prior notice.