

*Thanks for buying the  WOUXUN transceiver.*

*This transceiver offers latest design, enhanced features, solid performances and easy accessibility. We believe you will be pleased with the high quality and reliable features for all your communication needs.*

**Warning** 

- » Please do not use the transceiver when you are in the exploding places (such as gas, dust smoke etc.)
- » Please turn off the transceiver while your car is being refueled or parked at the gas station.

## User Safety, Training, and General Information

READ THIS IMPORTANT INFORMATION ON SAFE AND EFFICIENT OPERATION BEFORE USING YOUR **Wouxun** PORTABLE TWO-WAY RADIO.

### Compliance with RF Energy Exposure Standards

Your **Wouxun** two-way radio is designed and tested to comply with a number of national and international standards and guidelines (listed below) regarding human exposure to radio frequency electromagnetic energy. This radio complies with the IEEE (FCC) and ICNIRP exposure limits for occupational/controlled RF exposure environment at duty cycles of up to 50% talk-50% listen and should be used for occupational use only. In terms of measuring RF energy for compliance with the FCC exposure guidelines, your radio radiates measurable RF energy only while it is transmitting (during talking), not when it is receiving (listening) or in standby mode.

#### **NOTE**

» The approved batteries supplied with this radio are rated for a 5-5-90 duty cycle (5% talk-5% listen-90% standby), even though this radio complies with the FCC occupational RF exposure limits at duty cycles of up to 50% talk.

**Wouxun**  
Professional FM Transceiver

Your **Wouxun** two-way radio Complies with the following of RF energy exposure standards and guidelines:

- United States Federal Communications Commission, Code of Federal Regulations; 47CFR part 2 sub-part J
- American National Standards Institute (ANSI)/Institute of Electrical and Electronic Engineers (IEEE) C95. 1-1992
- Institute of Electrical and Electronic Engineers (IEEE) C95. 1-1999 Edition
- International Commission on Non-Ionizing Radiation Protection (ICNIRP) 1998

### Operational Instructions and Training Guidelines

To ensure optimal performance and compliance with the occupational/controlled environment RF energy exposure limits in the above standards and guidelines, users should transmit no more than 50% of the time and always adhere to the following procedures:

#### Transmit and Receive

To transmit (talk), push the Push-To-Talk (PTT) button; to receive, release the PTT button.

#### Hand-held radio operation

Hold the radio in a vertical position with the microphone 5 cm away from the lips and let the antenna

farther away from your head.

### Body-worn operation

Always place the radio in an **Wouxun** approved clip, holder, holster, case, or body harness for this product. Use of non-**Wouxun** -approved accessories may exceed FCC RF exposure guidelines.

### Antennas & Batteries

- Use only **Wouxun** approved, supplied antenna or **Wouxun** approved replacement antenna.
- Unauthorized antennas, modifications, or attachments could damage the radio and may violate FCC regulations.
- Use only **Wouxun** approved, supplied batteries or **Wouxun** approved replacement batteries.
- Use of non-**Wouxun** -approved batteries may exceed FCC RF exposure guidelines.

### Approved Accessories

For a list of **Wouxun** approved accessories, see the accessories page of this user manual or visit the following website which lists approved accessories: <http://www.wouxun.com>

### Notices to the User

- Government law prohibits the operation of unlicensed radio transmitters within the territories under government control.
- Illegal operation is punishable by fine or imprisonment or both.
- Refer service to qualified technicians only.

### **Warning**

- » It is important that the operator is aware of and understand hazards common to the operation of any transceiver. Explosive environment (such as gases, dust, fumes, etc). Turn off your transceiver while talking on fuel, or while parked in gasoline service stations.
- » If you require this machine to be developed or some changed, please connect with **Wouxun** or your **Wouxun** dealer.

### FCC Caution:

This equipment has been tested and found to comply with the part 90 of the FCC Rules. These limits are designed to provide reasonable protection against harmful interference in a residential installation. This equipment generates, uses and can radiate radio frequency energy and, if not installed and used in accordance with the instructions, may cause harmful interference to radio communications. However, there is no guarantee that interference will not occur in a particular installation. If this equipment does

cause harmful interference to radio or television reception, which can be determined by turning the equipment off and on, the user is encouraged to try to correct the interference by one or more of the following

**Measures:**

- Reorient or relocate the receiving antenna.
- Increase the separation between the equipment and receiver.
- Connect the equipment into an outlet on a circuit different from that to which the receiver is connected.
- Consult the dealer or an experienced radio/TV technician for help.

**FCC Licensing Requirements**

Your radio must be properly licensed Federal Communications Commission prior to use. Your **Wouxun** Wireless dealer can assist you in meeting these requirements. Your dealer will program each radio with your authorized frequencies, signaling codes, etc., and will be there to meet your communications needs as your system expands.

**Precautions**

Only qualified technicians are allowed to maintain this product.

Do not use the radio or charge a battery in explosive areas such as coal gas, dust, steam, etc.

**Switch OFF the radio while refueling or parking at gas station.**

Do not modify or adjust this radio without permission.

Do not expose the radio to direct sunlight over a long time, nor place it close to heating source.

Do not place the radio in excessively dusty, humid areas, nor on unstable surfaces.

Safety: It is important that the operator is aware of and understands hazards common to the operation of any radio.

**This device complies with Part 15 of the FCC Rules.**

Operation is subject to the following two conditions:

- (1) this device may not cause harmful interference, and
- (2) this device must accept any interference received, including interference that may cause undesired operation.

**Warning** 

» MODIFICATION OF THIS DEVICE TO RECEIVE CELLULAR RADIOTELEPHONE SERVICE SIGNALS IS PROHIBITED UNDER FCC RULES AND FEDERAL LAW.

## CE Caution:

Hereby,  **Wouxun** declares that this Two-way radio is in compliance with the essential requirements and other relevant provisions of Directive 1999/5/EC.

A copy of the DOC may be obtained through the following address.

Address: No.928 Nanhuan Road, Jiangnan High Technology Industry Park, Quanzhou, Fujian 362000,  
China

## Contents

  
Professional FM Transceiver

|  |              |
|--|--------------|
| <b>Unpacking and checking the equipment</b> .....                              | <b>01</b>    |
| <i>Supplied accessories</i> .....  | <b>01</b>    |
| <b>Description of functions</b> .....  | <b>02-03</b> |
| <b>Getting started</b> .....   | <b>04-08</b> |
| <i>LCD Display</i> .....   | <b>04</b>    |
| <i>Description of transceiver</i> .....  | <b>05-08</b> |
| <b>Shortcut Operation Sheet</b> .....  | <b>09-12</b> |
| <b>How to Operate</b> .....  | <b>13-44</b> |
| <i>Menu lock function</i> .....  | <b>13-14</b> |
| <i>Setting frequency step (STEP) ----- MENU 1</i> .....                        | <b>14</b>    |
| <i>Setting squelch level (SQL-LE) ----- MENU 2</i> .....                       | <b>15</b>    |
| <i>Setting power saver mode (SAVE) ----- MENU 3</i> .....                      | <b>15-16</b> |
| <i>Selecting transmitting power (TXP) ----- MENU 4</i> .....                   | <b>16</b>    |
| <i>Setting transmitting beginning/ending prompt (ROGER) ----- MENU 5</i> ..... | <b>17</b>    |
| <i>Time-out timer (TOT) ----- MENU 6</i> .....                                 | <b>17</b>    |
| <i>Setting VOX (VOX) ----- MENU7</i> .....                                     | <b>18</b>    |
| <i>Setting wide or narrow bandwidth (WN) ----- MENU 8</i> .....                | <b>18</b>    |

## Contents

|  |       |
|--|-------|
| Setting voice guide (VOICE) ----- MENU 9                                     | 19    |
| Setting transmitting overtime alarm (TOA) ----- MENU10                       | 19    |
| Beep prompt function (BEEP) ----- MENU 11                                    | 20    |
| Setting power-on message (PONMSG) ----- MENU 12                              | 20    |
| Busy channel lockout (BCL) ----- MENU 13                                     | 21    |
| Setting keypad lock(AUTOLK) ----- MENU 14                                    | 21-22 |
| Setting receiving CTCSS (R-CTCSS) ----- MENU 15                              | 22    |
| Setting transmitting CTCSS (T-CTCSS) ----- MENU 16                           | 23    |
| Setting receiving DCS (R-DCS) ----- MENU 17                                  | 23    |
| Setting transmitting DCS (T-DCS) ----- MENU 18                               | 24    |
| Setting scan mode (SC-REV) ----- MENU 19                                     | 24    |
| Setting SCAN / LAMP / SOS-CH / FM Radio function on side key 1 ----- MENU 20 | 25-28 |
| Working mode (CH-MDF) ----- MENU 21  | 29-30 |
| Setting auto backlight (ABR) ----- MENU 22                                   | 30-31 |
| Setting offset frequency (OFF-SET) ----- MENU23                              | 31-32 |
| Setting frequency shift direction (SFT-D) ----- MENU 24                      | 32-33 |
| Setting stopwatch timer function (SECOND) ----- MENU 25                      | 33    |
| Channel name editing (CHNAME) ----- MENU 26                                  | 34-35 |

|  |       |
|--|-------|
| Setting memory channel (MEM-CH) ----- MENU 27                                      | 35-36 |
| Deleting channel (DEL-CH) ----- MENU 28  | 37    |
| Setting reset ----- MENU 29  | 37-38 |
| CTCSS/DCS scan ----- MENU 30   | 39    |
| DTMF encoding  | 40    |
| Editing/Transmitting ANI ID Code, ANI ID Code transmitting delay and DTMF Sidetone | 40-41 |
| Setting priority scan function   | 42    |
| Setting reverse frequency function   | 42    |
| Low voltage prompt   | 43    |
| Setting transmitting overtime prompt   | 43    |
| Adding scanning channel  | 43    |
| Wire-clone function  | 44    |
| Working with repeater function   | 44-45 |
| How to use the intelligent charger   | 45-46 |
| Programming guide  | 46-47 |
| Trouble shooting   | 48-49 |
| Technical parameter  | 50-52 |

## Contents

|                                      |       |
|--------------------------------------|-------|
| <i>Appendix 1 (CTCSS)</i> .....      | 50    |
| <i>Appendix 2 (DCS)</i> .....        | 51-52 |
| <b>Technical specification</b> ..... | 53    |
| <b>Optional accessories</b> .....    | 54    |
| <b>Announcement</b> .....            | 55    |

## Unpacking and checking of your equipment

  
Professional FM Transceiver

Carefully unpack the transceiver. We recommend that you identify the items in the following table before discarding the packing material. If any items are missing or have been damaged during shipment, please notify your **Wouxun** dealer.

### Supplied accessories

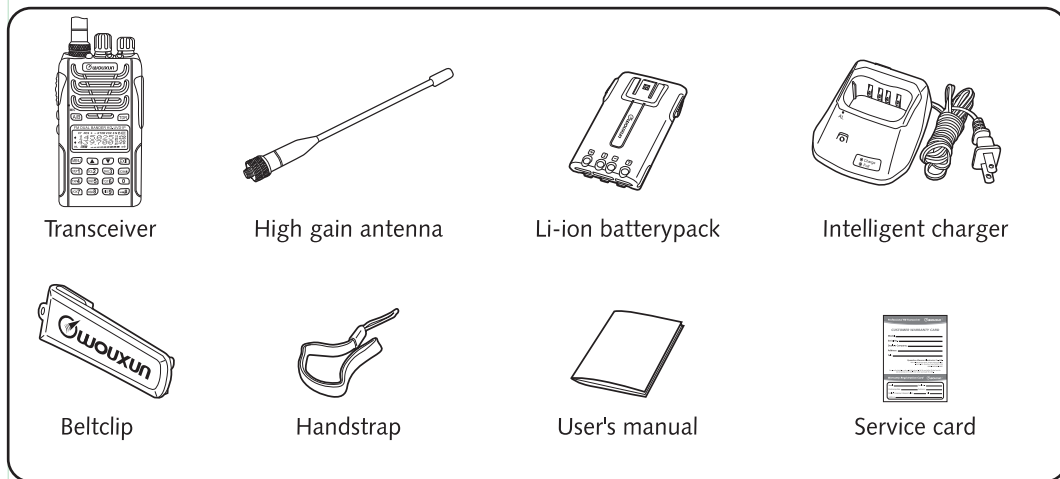

## Description of functions

1. Dual Band, Dual Frequency, Dual Display and Dual Standby
  2. Frequency Range (can be suitable for different countries or areas):  
136-174MHz & 350-470MHz (Rx / Tx),      136-174MHz & 400-480MHz (Rx / Tx),  
136-174MHz & 420-520MHz (Rx / Tx),      136-174MHz & 400-470MHz (Rx / Tx),  
136-174MHz & 245-250MHz (Rx / Tx),      136-174MHz & 216-280MHz (Rx / Tx),  
136-174MHz & 225-226MHz (Rx / Tx),      144-146MHz & 430-440MHz (Rx / Tx).  
66-88MHz & 400-480MHz (Rx / Tx).
  3. Working Mode: U-V, V-V or U-U selectable
  4. Channel setting: VHF Tx & UHF Rx or UHF Tx & VHF Rx selectable
  5. DTMF encoding
  6. Digital FM Radio (76-108MHz)
  7. CTCSS/DCS scan
  8. Output power: 5W VHF /4W UHF
  9. 128 memory channels
  10. VOX
  11. Stopwatch timer function
  12. 105 groups DCS and 50 groups CTCSS
  13. Voice guide
  14. SOS Function
  15. Wide/Narrow bandwidth selection (25KHz / 12.5KHz)
  16. Multi-display modes ( channel order number/ channel frequency/ channel name selectable)
- 02

17. Reverse frequency
18. Multi-functional scan modes
19. Priority scan function
20. Bright flashlight illumination
21. Frequency steps selectable (5/6.25/10/12.5/25KHz/50KHz/100KHz)
22. High/Low power changeable when transmitting
23. High capacity Li-ion battery pack
24. Intelligent charger
25. Offset frequency setting (0-69.950MHz)
26. Frequency shift direction setting
27. Busy channel lockout
28. Power-on message (Battery-V/Full Screen/Other Characters)
29. Low voltage prompt
30. Transmitting beginning/ending prompt
31. Transmitting overtime prompt
32. Keypad lock (Auto / Manual)
33. Adding scanning channel
34. High/Low power switchable when transmitting
35. Programmable by computer
36. Wire-clone function
37. Menu/Channel reset
38. 1750Hz Burst Tone



## Getting Started

### LCD display

There are various indicators displaying on the screen when powering on. Please refer the below table to learn what the indicators stand for accordingly.

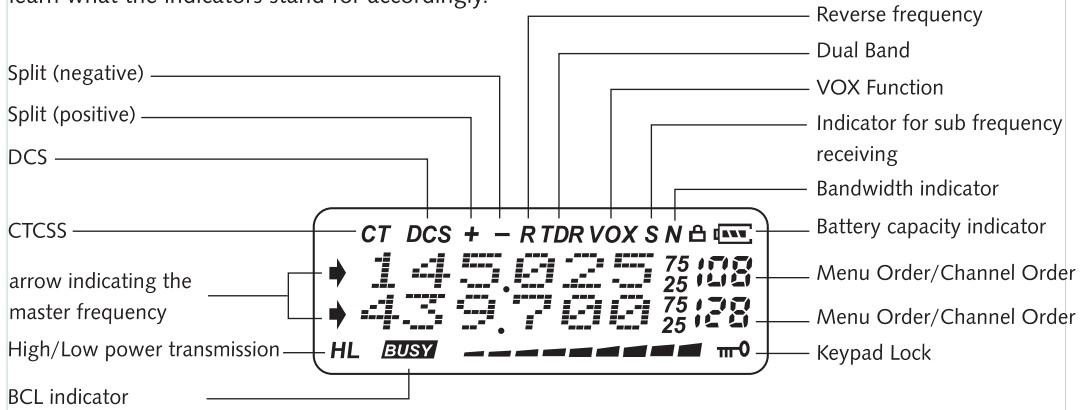

### Note:

- [Full Battery Icon] Full indicator for battery capacity
- [Exhausted Battery Icon] Exhausted indicator for battery capacity
- [Low Battery Icon] Low indicator for battery capacity
- [Signal Meter Icon] Receiving signal meter

04

### Description of transceiver

**wouxun**  
Professional FM Transceiver

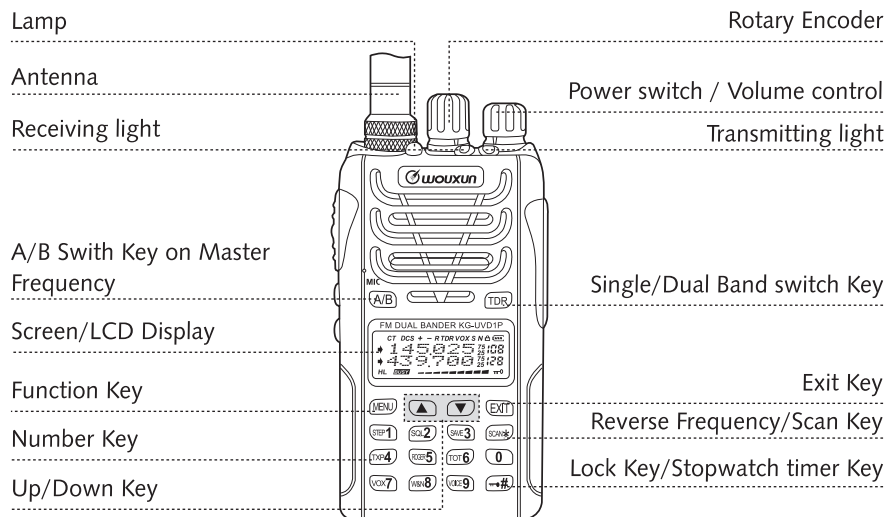

- Note:** Quickly switch the working mode ( **MENU** + **TDR** )  
Quickly resume the transceiver ( **MENU** + **A/B** )

05

## Getting Started

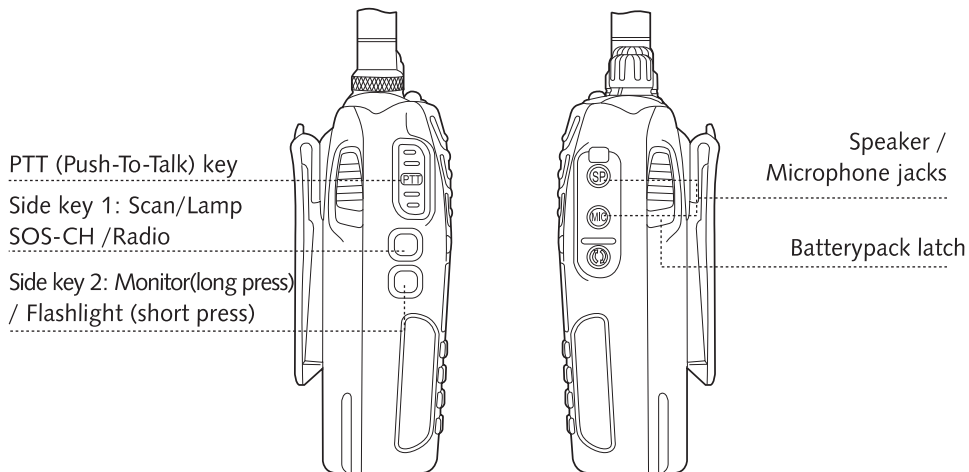

06

### ■ Quick Search

Press ▲ or ▼ key one time to search the desired function or parameter when setting for each function or parameter, while keeping pressing ▲ or ▼ key to quickly search.

### ■ Single/Dual Band Switch

Press **TDR**

Single Band ----- Dual Band

### ■ Quickly resume the transceiver

In standby, press **MENU** + **A/B**, then LCD displays **STEP SURE?**. Press **MENU** to confirm, and then the transceiver re-starts.

### ■ A/B Switch

Press **A/B** to select the master frequency. The frequency with arrowhead mark is the master frequency, while the other frequency without arrowhead mark is the sub frequency. The transceiver can transmit and receive in the master frequency, but ONLY receives in the sub frequency. When it is receiving in the sub frequency, there shows " S " in the screen.

07

## Getting Started

### SCAN key

Short press the **SCAN** key to set the reverse frequency, while keeping pressing for 2 seconds to active the scan function.

### Side key 2 (Flashlight/ Monitor selectable)

Short press the side key to turn ON/OFF the flashlight, while keeping pressing for 2 seconds to activate the monitor function.

### 1750Hz Burst Tone

Sometimes, 1750Hz Burst tone is required to carry out some other specific functions. This transceiver has 1750Hz Burst tone to help you.

#### How to use

In standby, press PTT key and side key PF1, the transceiver will transmit 1750Hz burst tone. The time keeping pressing PTT key and the side key PF1 determines the 1750Hz burst tone transmitting time. Releasing PTT key and the side key PF1 is to finish transmitting the 1750Hz burst tone.

## Shortcut operation sheet

| Function order | Function name                         | Enter function set | Screen display | Select parameter                            | Selectable parameter explanation   | Confirm | Return to standby | See page   |
|----------------|---------------------------------------|--------------------|----------------|---|--|---------|-------------------|------------|
| 1              | Setting frequency step                | MENU → STEP1       | STEP<br>12.50K | MENU → Press ▲ or ▼ key<br>Select parameter | 7 kinds of frequency steps 5K/<br>6.25K/10K/12.5K/25K/50K/100K   | MENU    | EXIT              | P14        |
| 2              | Setting squelch level                 | MENU → SQL2        | SQL-LE<br>5    | MENU → Press ▲ or ▼ key<br>Select parameter | Squelch level from 0 to 9  | MENU    | EXIT              | P15        |
| 3              | Setting power saver mode              | MENU → SAVE3       | SAVE<br>ON     | MENU → Press ▲ or ▼ key<br>Select parameter | ON: Turn on save function<br>OFF: Turn off save function   | MENU    | EXIT              | P15<br>-16 |
| 4              | Selecting transmitting power          | MENU → TXP4        | TXP<br>HIGH    | MENU → Press ▲ or ▼ key<br>Select parameter | H: High power (VHF 5W/UHF 4W)<br>L: Low power (1W)   | MENU    | EXIT              | P16        |
| 5              | Transmitting beginning/ ending prompt | MENU → ROGER5      | ROGER<br>OFF   | MENU → Press ▲ or ▼ key<br>Select parameter | OFF: turn off this function, without<br>any voice prompting.<br>BOT: press PTT, voice prompt when<br>begin transmitting<br>EOT: release PTT, voice prompt<br>when end transmitting<br>BOTH: press and release PTT, voice<br>prompt | MENU    | EXIT              | P17        |
| 6              | Time-out timer                        | MENU → TOT6        | TOT<br>60      | MENU → Press ▲ or ▼ key<br>Select parameter | TOT has 40 levels in steps<br>of 15 seconds.<br>OFF: Turn off TOT  | MENU    | EXIT              | P17        |
| 7              | Setting VOX                           | MENU → VOX7        | VOX<br>OFF     | MENU → Press ▲ or ▼ key<br>Select parameter | VOX has levels from 1 to 10<br>OFF: Turn off VOX transmission  | MENU    | EXIT              | P18        |
| 8              | Setting bandwidth                     | MENU → WNR8        | WNR<br>WIDE    | MENU → Press ▲ or ▼ key<br>Select parameter | WIDE: 25KHz<br>NARR: 12.5KHz   | MENU    | EXIT              | P18        |

## Shortcut operation sheet

|                                |                        |                |        |                                      |   |                    |
|--------------------------------|------------------------|----------------|--------|--------------------------------------|---|--------------------|
| 9 Voice guide                  | MENU → VOICE9 →        | • VOICE CHINES | MENU → | Press ▲ or ▼ key<br>Select parameter | CHINES: Chinese voice prompt<br>ENGLISH: English voice prompt<br>OFF: Turn off voice prompt | MENU → EXIT P19    |
| 10 Transmitting overtime alarm | MENU → STEP1 → 0 →     | • TOA 5        | MENU → | Press ▲ or ▼ key<br>Select parameter | 1 to 10 levels with 1 second each<br>OFF: turn off TOA                                      | MENU → EXIT P19    |
| 11 Setting beep prompt         | MENU → STEP1 → STEP1 → | • BEEP ON      | MENU → | Press ▲ or ▼ key<br>Select parameter | ON: Turn on beep prompt function<br>OFF: Turn off beep prompt function                      | MENU → EXIT P20    |
| 12 Power on message            | MENU → STEP1 → SQL2 →  | • PMSG OFF     | MENU → | Press ▲ or ▼ key<br>Select parameter | OFF: Full screen display<br>BATT: Battery voltage display<br>MSG: WELCOME                   | MENU → EXIT P20    |
| 13 Busy channel lockout        | MENU → STEP1 → SAVE3 → | • BCL OFF      | MENU → | Press ▲ or ▼ key<br>Select parameter | ON: Turn on BCL<br>OFF: Turn off BCL  | MENU → EXIT P21    |
| 14 Keypad lock                 | MENU → STEP1 → TXP4 →  | • AUTOLK OFF   | MENU → | Press ▲ or ▼ key<br>Select parameter | ON: Turn on Autolock<br>OFF: Turn off Autolock  | MENU → EXIT P21-22 |
| 15 Receiving CTCSS             | MENU → STEP1 → ROL5 →  | • R-CTC OFF    | MENU → | Press ▲ or ▼ key<br>Select parameter | 50 groups CTCSS (67.0Hz-254.1Hz)<br>OFF: Turn off CTCSS                                     | MENU → EXIT P22    |
| 16 Transmitting CTCSS          | MENU → STEP1 → TOT6 →  | • T-CTC OFF    | MENU → | Press ▲ or ▼ key<br>Select parameter | 50 groups CTCSS (67.0Hz-254.1Hz)<br>OFF: Turn off CTCSS                                     | MENU → EXIT P23    |
| 17 Receiving DCS               | MENU → STEP1 → VOX7 →  | • R-DCS OFF    | MENU → | Press ▲ or ▼ key<br>Select parameter | 105 groups DCS (D023N-D754N)<br>OFF: Turn off DCS   | MENU → EXIT P23    |

10

|  |                         |                 |        |                                      |   |                    |
|---|-------------------------|-----------------|--------|--------------------------------------|---|--------------------|
| 18 Transmitting DCS   | MENU → STEP1 → WAX8 →   | • T-DCS OFF     | MENU → | Press ▲ or ▼ key<br>Select parameter | 105 groups DCS (D023N-D754N)<br>OFF: Turn off DCS   | MENU → EXIT P24    |
| 19 Scan mode  | MENU → STEP1 → VOICE9 → | • SC-REU TO     | MENU → | Press ▲ or ▼ key<br>Select parameter | 3 kinds of Scan modes<br>TO: Time scanning mode<br>CO: Carrier mode 1 scan<br>SE: Carrier mode 2 scan   | MENU → EXIT P24    |
| 20 Scan/Lamp SOS-CH/Radio/(Side key 1)  | MENU → SQL2 → 0 →       | • PF1 RADIO     | MENU → | Press ▲ or ▼ key<br>Select parameter | SCAN: Activate scan<br>LAMP: Turn on Lamp<br>SOS-CH: SOS function<br>RADIO: Turn on FM radio<br>OFF: Inactivate   | MENU → EXIT P25-28 |
| 21 Working mode   | MENU → SQL2 → STEP1 →   | • CH-MDF FREQ   | MENU → | Press ▲ or ▼ key<br>Select parameter | This transceiver has two working modes available:<br>1. Frequency mode (FREQ)<br>2. Channel mode<br>Three kinds of channel mode available:<br>① Channel (CH)<br>② Frequency + Channel number (CH FREQ)<br>③ Channel name (NAME) | MENU → EXIT P29-30 |
| 22 Auto backlight   | MENU → SQL2 → SQL2 →    | • ABR ON        | MENU → | Press ▲ or ▼ key<br>Select parameter | ON: Turn on backlight<br>OFF: Turn off backlight  | MENU → EXIT P30-31 |
| 23 Offset frequency   | MENU → SQL2 → SAVE3 →   | • OFFSET 00.000 | MENU → | Press ▲ or ▼ key<br>Select parameter | 0-69.950MHz available   | MENU → EXIT P31-32 |
| 24 Frequency shift direction  | MENU → SQL2 → TXP4 →    | • SFT-D OFF     | MENU → | Press ▲ or ▼ key<br>Select parameter | + Positive direction<br>- Negative direction<br>OFF: Turn off frequency shift direction   | MENU → EXIT P32-33 |
| 25 Stopwatch  | MENU → SQL2 → ROL5 →    | • SECOND OFF    | MENU → | Press ▲ or ▼ key<br>Select parameter | ON: Turn on Stopwatch function<br>OFF: Turn off Stopwatch function  | MENU → EXIT P33    |

11

## How to operate

|                         |                                     |   |  |                    |
|-------------------------|-------------------------------------|---|--|--------------------|
| 26 Channel name editing | MENU → SOL2 → TOT6 → CHNAME 26      | MENU → Press ▲ or ▼ key<br>Select parameter | Channel name should be with in 26 letters (A to Z) and 10 numbers (0 to 9), six maximum. | MENU → EXIT P34-35 |
| 27 Memory channel       | MENU → SOL2 → VOX7 → MEM-CH 27      | MENU → Press ▲ or ▼ key<br>Select parameter | 128 channels available   | MENU → EXIT P35-36 |
| 28 Deleting channel     | MENU → SOL2 → W&N8 → DEL-CH 28      | MENU → Press ▲ or ▼ key<br>Select parameter | 128 channels available   | MENU → EXIT P37    |
| 29 Reset                | MENU → SOL2 → VOICE9 → RESET UFO 29 | MENU → Press ▲ or ▼ key<br>Select parameter | VFO: Menu reset<br>ALL: All parameter reset  | MENU → EXIT P37-38 |
| 30 CTCSS/DCS scan       | MENU → SAVE3 → 0 → SCN CD CTCSS 30  | MENU → Press ▲ or ▼ key<br>Select parameter | CTCSS: CTCSS scan<br>DCS: DCS scan   | MENU → EXIT P39    |

- Quick Search ▲ / ▼ (See page 07 )
- High/Low power changeable (See page 16)
- DTMF encoding (See page 40 )
- Set reverse frequency SCAN# (See page 42 )
- Setting transmitting overtime prompt (See page 43 )
- Wire-clone function (See page 44 )
- Programming guide (See page 46-47 )
- 1750Hz Burst Tone (See page 08)
- SOS-CH (SOS function) (See page 26)
- Priority scan function (See page 42 )
- Low voltage prompt (See page 43 )
- Adding scanning channel function (See page 43 )
- Working with repeater (See page 44-45 )

12

## How to operate

**Wouxun**  
Professional FM Transceiver

### Menu Lock function

Sometimes if the menu is not need to be operated frequently, you can lock the menu via the programming software. Please see the detailed steps as follow:

1. Set the password to switch between the frequency mode and the channel mode.
2. Set channel mode as the working mode.
3. Turn off operating menu function in the channel mode.

It is programmable to input the password manually and switch to the frequency mode to activate the keypad options if the operating menu is needed.

#### NOTE

- » In dual standby mode, the screen shows "TDR". The frequency with arrowhead mark is the master frequency while the other without arrowhead mark is the sub frequency. When the sub frequency is receiving, there shows "s" in the screen. In the dual standby mode, the transceiver ONLY transmits in the master frequency and receives in the sub frequency.
- » Master Frequency Setting  
In dual standby, press A/B to select the master frequency.
- » This transceiver is the dual bander, with dual frequency and dual display functions. In frequency mode, it can display two different receiving/ transmitting frequencies at the same time. In channel mode, it can also display the channel frequency and related parameter in both channels at the same time.

13

## How to operate

### NOTE

- » In frequency/Channel mode, it is switchable between band A and band B by **A/B** key, When the A/B indicator shows in band A, all the operations are based on band A. While the indicator shows in band B, all the operations are based on band B.
- » In frequency mode, it is available to separately set the frequency step, transmitting power, squelch level, bandwidth, CTCSS, DCS, offset frequency, frequency shift direction and channel display modes in band A or band B.
- » In channel mode, it is invalid to set frequency step, transmitting power, CTCSS, DCS, bandwidth, offset frequency, and frequency shift direction functions in band A and band B.

### Setting frequency step (STEP) ----- MENU 1

In standby, press **MENU** + **STEP1**, the screen displays 

Press **MENU** to enter, it shows '12.50K', press **▲** / **▼** to select the desired step, then press **MENU** to confirm, finally press **EXIT** to return to standby.

The frequency steps selectable for this transceiver are as follow:

5.00KHz, 6.25KHz, 10.00KHz, 12.50KHz, 25.00KHz, 50.00KHz and 100KHz.

### Setting squelch level (SQL-LE) ----- MENU 2

Squelch level is about when the signal is strong enough to turn on the squelch function, and when it is weak enough to turn off the squelch function. When the squelch is on, there is voice from the loudspeaker for all of the signaling set by the transceiver. When the squelch level is set too high, the weaker signals may be missed, while the squelch level is set too low, the transceiver maybe disturbed by some noise or other needless signals.

### NOTE

- » The squelch level for this transceiver has 0-9 levels selectable, and level 0 is to turn off the squelch function. The higher level the squelch is set, the stronger receiving signal is needed.

In standby, press **MENU** + **SQL2**, the screen displays 

Press **MENU** to enter, it shows '5', press **▲** / **▼** to select the desired squelch level, then press **MENU** to confirm, finally press **EXIT** to return to standby.

### Setting power saver mode (SAVE) --- MENU 3

When the power saver function is ON, the receiver circuit will be cut off for the moment, and then re-activate to detect the signals for a while, in order to reduce the battery capacity consumption.

## How to operate

In standby, press **MENU** + **SAVE3**, the screen displays 

Press **MENU** to enter, it shows 'ON', press **▲** / **▼** to select turn ON/OFF the power saver function.

Press **MENU** to confirm, and then press **EXIT** to return to standby.

### Selecting transmitting power (TXP) --- MENU 4

In frequency mode, press **MENU** + **TXP4**, the screen displays 

Press **MENU** to enter, it shows 'HIGH', press **▲** / **▼** to select HIGH/LOW power, then press **MENU** to confirm, finally press **EXIT** to return to standby.

### NOTE

» This transceiver has HIGH and LOW transmitting power selectable:

VHF: HIGH: 5W LOW: 1W

UHF: HIGH: 4W LOW: 1W

» The quick switch between the HIGH and LOW transmitting power is temporary. In transmitting mode, press **TDR** key to quick switch the HIGH/LOW transmitting power. Once the transceiver is resumed, the transmitting power reverts to the original output power.

### Setting transmitting beginning/ending prompt (ROGER) --- MENU 5

This function is to select the prompt modes when beginning/ending transmitting as followings:

**OFF:** Press and release PTT key, there is no prompt for either beginning or ending transmitting.

**BOT:** Press PTT key, there is prompt for the beginning transmitting.

**EOT:** Release PTT key, there is prompt for the ending transmitting.

**BOTH:** Press and release PTT key, there is prompt for both beginning/ending transmitting.

In standby, press **MENU** + **ROGER5**, the screen displays 

Press **MENU** to enter, it shows 'OFF', press **▲** / **▼** to select OFF/BOT/EOT/BOTH, then press **MENU** to confirm, finally press **EXIT** to return to standby.

### Time-out Timer (TOT) --- MENU 6

This function is to prevent the transceiver from transmitting for too long time. When the transceiver is exceeding the preset time limit, it will stop transmitting with an overtime alarm.

This transceiver can be set in 40 levels with 15 seconds each, between 15 and 600 seconds.

In standby, press **MENU** + **TOT6**, the screen displays 

Press **MENU** to enter, it shows '60', press **▲** / **▼** to select the desired transmitting level, then press **MENU** to confirm, finally press **EXIT** to return to standby.

## How to operate

### Setting VOX (VOX) --- MENU 7

This transceiver will switch to the transmitting mode when detecting the voice signal.

The transmitting operation will somewhat be delayed, and the voice signal information may be not transmitted at the first beginning, since there needs some time for the VOX circuit to detect the voice signal.

In standby, press **MENU** + **VOX7**, the screen displays 

Press **MENU** to enter, it shows 'OFF', press **▲** / **▼** to turn OFF VOX function or select VOX level (1-10), then press **MENU** to confirm, finally press **EXIT** to return to standby.

### NOTE

- » The higher level of VOX is set, the higher volume is needed.
- » In SCAN and RADIO modes, the VOX function is not available, but just showing VOX mark on the upper right of the display screen.

### Setting wide or narrow bandwidth (WN) --- MENU 8

In standby, press **MENU** + **WN8**, the screen displays 

Press **MENU** to enter, it shows 'WIDE', press **▲** / **▼** to select WIDE/NARROW bandwidth, then press **MENU** to confirm, finally press **EXIT** to return to standby.

18

### Setting voice guide (VOICE) --- MENU 9

In standby, press **MENU** + **VOICE9**, the screen displays 

Press **MENU** to enter, press **▲** / **▼** to select Chinese, English or OFF, and then press **MENU** key to confirm, finally press **EXIT** to return to standby.

### NOTE

- » Please turn off MENU 9 and MENU 11 at the same time to turn off all the voice prompt for this transceiver.

### Setting transmitting overtime alarm (TOA) --- MENU 10

This alarm is the pre-alert time when the transmitting time is nearly up to requested transmitting time.

When the time is up, the transceiver sounds out the beep prompt and the LCD keeps flashing.

This transceiver can be set from 1 to 10 TOA level with 1 second each. Level 1 means that the prompt 1 second ahead when the transmitting time is up to the TOT preset time.

In standby, press **MENU** + **STEP1 0**, the screen displays 

Press **MENU** to enter, it shows '5', press **▲** / **▼** to select OFF/1~10 Level, then press **MENU** to confirm, press finally **EXIT** to return to standby.

19



## How to operate

### Beep prompt function (BEEP) --- MENU 11

Beep prompt function is for the transceiver operating confirmation, error status prompt or faulty condition reminders. We faithfully advise you to keep this function ON, so that you can detect or check the errors and faults in time.

In standby, press **MENU** + **STEP1** **STEP1**, the screen displays 

Press **MENU** to enter, it shows 'ON', press **▲** / **▼** to select turn ON/OFF the beep prompting function, then press **MENU** to confirm, press finally **EXIT** to return to standby.

#### NOTE

>> When MENU 9 VOICE function and MENU 11 BEEP function are both on at the same time, the VOICE function is prioritized.

### Setting power on message (PONMSG) --- MENU 12

This transceiver has 3 display modes selectable for the power on message as follow:

**OFF:** display the full screen

**BATT-V:** display the current battery voltage

**MSG:** display 'WELCOME'

In standby, press **MENU** + **STEP1** **SO2**, the screen displays 

Press **MENU** to enter, it shows 'OFF', press **▲** / **▼** to select OFF/BATT-V/MSG, then press **MENU** to confirm, finally press **EXIT** to return to standby.  
20

### Busy channel lockout (BCL) --- MENU 13

This function is to prevent the interference from the other communicating channels. When the selected channel is occupied by others, press PTT and there will be an alarm prompt for BCL, while release PTT, the alarm prompt disappears and the transceiver will be back to the receiving mode.

In frequency mode, press **MENU** + **STEP1** **SAVE3**, the screen displays 

Press **MENU** to enter, it shows 'OFF', press **▲** / **▼** to select ON/OFF this function, then press **MENU** to confirm, finally press **EXIT** to return to standby.

### Setting keypad lock (AUTOLK) --- MENU 14

This transceiver has automatical lock (AUOLK) and manual lock selectable.

**ON:** When the AUTOLK is on, there are no operations within 15 seconds, the transceiver will be locked automatically. Press **↔#** more than 2 seconds to unlock the keypad.

**OFF:** The AUTOLK is off, it is only available to lock the keypad manually.

#### NOTE

>> According to the manual lock, press **↔#** for more than two seconds to lock in standby mode, and press **↔#** for more than two seconds again to unlock it.

## How to operate

In standby, press **MENU** + **STEP1** **TXP4**, the screen displays . Press **MENU** to enter, it shows 'OFF', press **▲** / **▼** to select ON/OFF this function, then press **MENU** to confirm, finally press **EXIT** to return to standby.

### Setting receiving CTCSS (R-CTCSS) --- MENU 15

Using the CTCSS/DCS can be used for you to receive the specified individual or group calls, and avoid the needless callings from others with the same frequency. Only receiving the same CTCSS/DCS signals, the transceiver can release the squelch.

In frequency mode, press **MENU** + **STEP1** **ROBE5**, the screen displays . Press **MENU** to enter, it shows 'OFF', press **▲** / **▼** to turn OFF this function or select 67.0Hz to 254.1Hz CTCSS code, then press **MENU** to confirm, finally press **EXIT** to return to standby.

#### NOTE

» This transceiver has 50 groups CTCSS, see appendix (1) CTCSS frequency sheet.

### Setting transmitting CTCSS (T-CTCSS) --- MENU 16

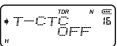
In standby, press **MENU** + **STEP1** **TOT6**, the screen displays . Press **MENU** to enter, it shows 'OFF', press **▲** / **▼** to turn OFF this function or select 67.0Hz to 254.1Hz CTCSS code, then press **MENU** to confirm, finally press **EXIT** to return to standby.

#### NOTE

» This transceiver has 50 groups CTCSS, see appendix (1) CTCSS frequency sheet.

### Setting receiving DCS (R-DCS) --- MENU 17

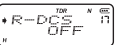
In frequency mode, press **MENU** + **STEP1** **VOX7**, the screen displays . Press **MENU** to enter, it shows 'OFF', press **▲** / **▼** to turn OFF this function or select D023N to D754I DCS code, then press **MENU** to confirm, finally press **EXIT** to return to standby.

#### NOTE

» This transceiver has 105 groups DCS, see appendix (2) DCS frequency sheet.  
» In DCS selections, DNXXX (from DN023 to DN754) means POSITIVE code, while DIXXX (from DI023 to DI754) means NEGATIVE code.

## How to operate

### Setting transmitting DCS (T-DCS) --- MENU 18

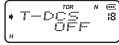
In standby mode, press **MENU** + **STEP1** **WAVE8**, the screen displays . Press **MENU** to enter, it shows 'OFF', press **▲** / **▼** to turn OFF this function or select D023N to D754I DCS code, then press **MENU** to confirm, finally press **EXIT** to return to standby.

#### NOTE

- » This transceiver has 105 groups DCS, see appendix (2) DCS frequency sheet.
- » In DCS selections, DNXXX (from DN023 to DN754) means POSITIVE code, while DIXXX (from DI023 to DI754) means NEGATIVE code.

### Setting scan mode (SC-REV) --- MENU 19

This transceiver has three scan modes:

**TO:** The transceiver continues scanning if there are no any operations 5 seconds after receiving signals.

**CO:** The transceiver pauses scanning when receiving signals, and continues scanning 3 seconds after the signal disappears.

**SE:** The transceiver stops scanning when receiving signals.

In standby mode, press **MENU** + **STEP1** **WAVE9**, the screen displays . Press **MENU** to enter, it shows 'TO', press **▲** / **▼** to select TO/CO/SE scan mode, then press **MENU** to confirm, finally press **EXIT** to return to standby.

24

### Setting SCAN / LAMP / SOS-CH / FM Radio function on side key 1 (PF1) --- MENU 20

There are four functions selectable on the side key 1 of this transceiver:

**SCAN:** Scan function

**LAMP:** Lamp function

**SOS-CH:** SOS function

**RADIO:** FM radio function

**OFF:** Disable this side key

#### 1. SCAN function:

In standby mode, press Side key 1 enter to activate scanning (scan mode can be set through MENU 19 -Scan Mode Setting), while press any keys to stop scanning in scan mode.

In standby mode, press **MENU** + **SQL2** **0**, the screen displays 

Press **MENU** to enter, press **▲** / **▼** to select SCAN, then press **MENU** to confirm, finally press **EXIT** to return to standby.

#### 2. LAMP function:

In standby mode, press Side key 1 to turn on the Lamp, and press this key again to turn it off.

In standby mode, press **MENU** + **SQL2** **0**, the screen displays 

Press **MENU** to enter, press **▲** / **▼** to select LAMP, then press **MENU** to confirm, finally press **EXIT** to return to standby.

## How to operate

### 3. SOS-CH (SOS function):

In emergency, the transceiver transmits the SOS signals to the outside surrounding on the specified Channel or Frequency in Band A or Band B. Meanwhile, the transceiver will sound "wu...wu..." with the green light keeping flashing. It will transmit signals every 5 minutes, lasting for 10 seconds each time. When the carrier signal receives in the SOS transmitting mode, the transceiver will automatically switch into the receiving mode. After the carrier signals disappear, the transceiver switches back to the SOS transmitting mode. Please press any key to exit in the SOS transmitting mode.

#### NOTE

- >> In case the SOS-CH frequency you set is not the master frequency, the transceiver will automatically set the SOS-CH frequency to be the master frequency in the SOS-CH mode. Meanwhile, the master frequency will not restore the settings before the SOS transmitting.
- >> Please press **A/B** key to reset the master frequency.

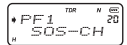
In standby, press **MENU** + **sq.2** **0**, then screen displays , then press **MENU** to enter, press **▲** / **▼** to choose SOS-CH submenu, the screen displays , press **MENU** again to confirm, press **▲** / **▼** to choose Band A or Band B, then press **MENU** to confirm, the transceiver sounds "wu...wu...", meanwhile the RED/GREEN/FLASHLIGHT keeps flashing, which means SOS-CH function is ON.

After above settings, switch the transceiver to the standby mode, and press PF1 side key to transmit the SOS signal.

26

### 4. RADIO function:

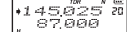
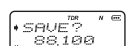
- **Turning on the FM radio:** In standby mode, press Side key 1 to turn on. The screen displays , then the indicator keeps flashing, which means transceiver is automatically tuning the radio stations. Once the transceiver gets tuned, it stops at this radio station and starts the listening.
- **Tuning the FM radio station:** In radio mode, press **SCAN**, the radio keeps tuning the stations automatically and the green light keeps flashing at the same time until it succeed in searching the available stations. You can press **▲** / **▼** to manually tune the radio stations.
- **Storing radio station:** After detecting a radio station, press **MENU**, the screen displays , and then select one of the number keys between **STEP1** and **CODE9**, the detected radio station will be stored into the chip for your future use.

The transceiver has two groups of storages selectable for your storing, and the default group is the first storage.

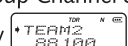
**E.g.** If you want to store 88.1MHz into the 1st group Channel 8, In radio mode, when tuning the desired radio station, press **MENU** + **MEM8** to store it into the 1st storage directly. If you want to store this frequency into the 2nd group Channel 8. In radio mode, when tuning the desired radio station, press **MEM#** then the screen will display . At this time, press **MENU** + **MEM8** to store this station into the 2nd group Channel 8. In radio mode, press 1 to 9 key to select the stored stations accordingly to listen to, while use the **MEM#** key to switch between 1st and 2nd storages.

## How to operate

- **Exiting from the radio mode:** Press Side key 1 again to exit from the radio mode.

### NOTE

- » When the FM radio is working, the current frequency or channel is in standby. Once detecting the receiving signals, the transceiver will automatically switch to receiving/transmitting mode. Five seconds after the signal disappears, the transceiver will switch back to the radio mode.
- » In FM radio mode, press **EXIT** to back to the current standby frequency, and press PTT to transmit. Five seconds after transmission, the transceiver will switch back to the radio mode.

## Working mode (CH-MDF) --- MENU 21

This transceiver has two options for the working mode:

1. Frequency mode (FREQ)
2. Channel mode

There are three channel display selections in channel mode as follow:

- ① Channel (CH)      ② Frequency + Channel number (CH FREQ)      ③ Channel name (NAME)

### NOTE

- » It is available to switch between the frequency mode and the channel mode manually or via the programming software. If you want, you can set the password for the mode switch.
- » The password for the mode switch is ONLY available to set via KG-UVD1P programming software.
- » There are 6 characters consist of the password, while "000000" means no password is needed for the mode switch.

## Frequency mode (FREQ) and Channel mode switchable

### ① Without password input

In standby, press **MENU** + **SQ2** **STEP1**, then press **▲** / **▼** to choose working mode and finally press **MENU** to confirm.

## How to operate

### ② With password input

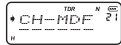
Please set the password for the mode switch via KG-UVD1P programming software. This password is consist of 6 charaters from 0 to 9. The valid password should be made up by six digits except "000000". In standby, press **MENU** + **SQL2** **STEP1**, then press **▲** / **▼** to choose one of **FREQ/NAME/CH/CHFREQ**. Press **MENU** to confirm, then the screen will display the password input . Please input the preset password through the keypad, then the transceiver will switch to the selected mode.

### NOTE

- » At least one channel is stored ahead into the transceiver, so that the above settings for the mode switch is workable.
- » Quickly switch between the frequency mode and the channel mode(CH).  
In standby, press **MENU** + **TDR** key to switch the mode. Without password input, you can switch it directly. Otherwise, you need to input the valid password accordingly.

### Setting auto backlight (ABR) --- MENU 22

In standby, press **MENU** + **SQL2** **SQL2**, the screen displays . Press **MENU** to enter, it shows 'ON', press **▲** / **▼** to turn ON/OFF auto backlight function, then press **MENU** to confirm, press **EXIT** return to standby.

30

### NOTE

- » When the ABR function is set ON, the backlight will not be activated in transmitting/receiving mode or pressing side key 2. Otherwise, operating on the keypad and the side key 1 will activate the backlight automatically.

### Setting offset frequency (OFF-SET) --- MENU 23

Offset frequency means the difference between transmitting frequency and receiving frequency. The range of the offset frequency for this transceiver is from 0 to 69.950MHz.

In standby mode, press **MENU** + **SQL2** **SAVE3**, the screen displays . Press **MENU** to enter, then press **▲** / **▼** to select the listed offset frequency, or manually input through keypad directly. Press **MENU** to confirm, while press **EXIT** return to standby.

In order to transmit and receive in different frequencies, it is necessary to set the offset frequency and the frequency shift direction in the frequency mode.

Please follow the below setting steps:



1. Set the working mode to the frequency mode.
2. Set the frequency shift direction and offset frequency.

31

## How to operate

E.g.: In frequency mode, the transceiver needs to work on receiving frequency 450.025MHz and transmitting frequency 460.025MHz.

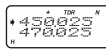
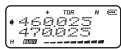
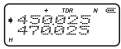
In Frequency mode, input **TXP4** **ROB5** **0** **0** **SQ2** **ROB5** then press **MENU** + **SQ2** + **TXP4** + **MENU** to select positive direction (+), press **MENU** + **EXIT**, then press **MENU** + **SQ2** + **SAE3** + **MENU** + **▲** / **▼** to choose 10.000+ **MENU** + **EXIT**, so the frequency shift direction and offset frequency are set.

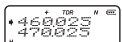
The screen displays , press PTT to transmit and the screen displays . Release PTT the screen displays  and it means receiving frequency is  while the transmitting frequency is .

### Setting frequency shift direction (SFT-D) ---- MENU24

There are three selections for the frequency shift direction setting:

- 1.Plus shift (+), which means the transmitting frequency is higher than the receiving frequency.
2. Minus shift (-), which means the transmitting frequency is lower than the receiving frequency.
3. Turn off this function.

In standby mode, press **MENU** + **SQ2** **TXP4**, the screen displays .

32

Press **MENU** to enter, press **▲** / **▼** to select +/- / OFF, then press **MENU** to confirm, finally press **EXIT** return to standby.

### Setting stopwatch timer (SECOND) --- MENU 25

In standby mode, press **MENU** + **SQ2** **ROB5**, the screen displays .

Press **MENU** to enter, it shows 'OFF', then press **▲** / **▼** to turn ON/OFF this function, press **MENU** to confirm, finally press **EXIT** to return to standby.

**Using the stopwatch timer:**

When this function is ON, press **↔#** to start counting, while press any key to pause. Press **↔#** again to re-start counting.

#### **NOTE**

» When it pauses counting, press any key (except **↔#** key) to exit from stopwatch timer function.

## How to operate

### Channel name editing (CHNAME) --- MENU 26



When editing the channel name, please aware:

1. the valid character should be within 26 letters (A to Z) and 10 numbers (0 to 9).
2. the name should be no more than 6 digits, and from 1 to 6 digits are selectable.
3. when manually editing, "-" means that this digit is blank.

#### Editing method









1. Via KG-UVD1P programming software.
2. Directly through the keypad manually.

#### When editing the channel name,

1. store at least one channel into the transceiver ahead.
2. set in the channel mode.
3. press  to select character while press  to select the desired digit.

#### Editing steps





1. Firstly, store into the desired channel into the transceiver. Please refer to the Memory Channel (MEN-CH) MENU27 accordingly.

2. Secondly, go to MENU 21 to select NAME as the working mode.
3. Select the desired channel, press  +  +  +  , the screen displays six '-' cross bar.  
Press  to select characters and press  , then press  again to select another digits. After finishing editing the desired name, press  to confirm, and press  to exit. The screen displays with the edited channel name and there also shows the channel number on the top right corner.

### Setting channel memory: Setting Co-Channel and Dis-Channel (MEM-CH) --- MENU 27

In frequency mode and in standby, it is available to store the desired frequencies and relevant parameter into the specified channel.

Input the desired frequency, then press  +   , the screen displays 

Press  to enter, press  /  to select channel, then press  to store, with the voice prompt "receiving memory". Press  to exit, the current channel is co-channel. If you need to store as dis-channel, repeat the above operation on another frequency, then there is another voice prompt "transmitting memory", which means different receiving frequency and transmitting frequency are stored as dis-channel.

**E.g.:** Store receiving frequency 450.025MHz and transmitting frequency 460.025MHz into CH-20 as dis-channel.



## How to operate

1. In frequency mode, input **TXP4** **RECE5** **0** **0** **SQL2** **RECE5** + **MENU** + **SQL2** **VOX7** + **MENU**, then press **SQL2** **0** or **▲** / **▼** to select CH-20, press **MENU** to confirm, voice prompt for receiving memory, then press **EXIT**.
2. Input **TXP4** **TRF6** **0** **0** **SQL2** **RECE5** + **MENU** + **SQL2** **VOX7** + **MENU** + **MENU**, voice prompt for transmitting memory, then press **EXIT**.
3. The dis-channel is set.

### NOTE

- » The relevant CTCSS/DCS tone with the receiving frequency should be set ahead the receiving memory, so that these settings can be stored into the desired channel with the frequency.
- » In transmitting memory, only the specified frequency point can be stored.
- » If the desired channel has already been stored, please select the channel before the transmitting and receiving memory. Only the desired channel is empty, can both the transmitting and receiving memory be done. Otherwise, only the transmitting memory can be manually programmed.
- » Besides the manual memory, it is also available to do the memory channel via the matching programming software.

### Deleting channel (DEL-CH) ----- MENU 28

In standby mode, press **MENU** + **SQL2** **W8**, the screen displays 

Press **MENU** to enter, and press **▲** / **▼** to select the desired channel, then press **MENU** to confirm, After the channel is deleted successfully, press **EXIT** to return to standby.

### Setting reset ---- MENU 29

This transceiver has two selections for the reset operation-VFO reset and ALL reset.

VFO reset means all the functional parameter set in frequency mode resumes to the factory setting.

ALL reset means all the functional parameter set in both frequency mode and channel mode resume to the factory setting.

#### 1. VFO Reset

In standby mode, press **MENU** + **SQL2** **VOX9**, the screen displays 

Press **MENU** to enter, and press **▲** / **▼** to select VFO, then press **MENU**, the screen displays , press **MENU** again to confirm, and the screen displays .

After this operation, the transceiver will be resumed automatically.

#### 2. All Reset

In order to avoid the faulty operations, we suggest that you set the password for the ALL Rset via



## How to operate

KG-UVD1P programming software. Only input the valid password, the transceiver can be reset to the factory setting completely. Pls see the password setting in the programming software, which is consist of six arabic numerals selectable from 0 to 9.

When the input password is "000000", it means no password is needed to input for this operation.



### (1) Setting password as "000000"

In standby, press **MENU** + **SQL2** **00009** , the screen displays 

Press **MENU** to enter, and press **▲** / **▼** to select ALL, press **MENU** , the screen displays  , then press **MENU** again to confirm, the screen displays  . when the reset is done, the transceiver will be resumed automatically.

### (2) Setting password as "XXXXXX" (E.g.: 123456)

In standby, press **MENU** + **SQL2** **00009** , the screen displays 

Press **MENU** to enter, and press **▲** / **▼** to select ALL, press **MENU** , the screen will displays  , at this time input the valid password (e.g.: 123456), the screen displays  , then the transceiver will start resetting. After reset is done, the transceiver will be resumed automatically.

38

## CTCSS/DCS scanning ----- MENU 30

When the transceiver detects the CTCSS/DCS signals from outside, this function can start scanning the CTCSS/DCS frequencies, which has already been set in this transceiver, and stop scanning at the matching CTCSS/DCS frequency with the transmitting CTCSS/DCS frequency.

When the transceiver receives CTCSS/DCS signal, press **MENU** + **SQL3** **0** , the screen displays 

Press **MENU** to enter, the arrowhead points to "CTCSS". Press **▲** / **▼** select to scan CTCSS or DCS.

And then press **MENU** to confirm, it starts scanning CTCSS/DCS frequencies.

### NOTE

- » This function only works in frequency mode.
- » Only when the transceiver detects the CTCSS/DCS signals from outside, this function works.
- » Press **▲** / **▼** or the Rotary Encoder to change the scanning direction.
- » When the transceiver scans to the matching CTCSS/DCS frequency, it stops at this frequency.  
You can press **MENU** to temporarily replace this frequency as the current standby frequency. If you want to directly set this scanned frequency to be current working frequency, please enter into MENU 15/16(CTCSS) or MENU 17/18(DCS) to save separately. Or it will be reset to the original setting before the next scanning.
- » Only the band with the arrowhead and detecting the signal can be activated to do next the CTCSS/DCS scanning.

39

## How to operate

### DTMF Encoding

**MENU** , **▲** , **▼** , **EXIT** keys are respectively corresponding to A, B, C, D at DTMF encoding setting. Please follow the below steps to activate DTMF manually:

1. Hold on pressing PTT key to transmit.
2. At the same time, press the keys on the keyboard to send out the DTMF tone.

#### **NOTE**

» This transceiver will monitor the transmission of corresponding DTMF tone.

### Editing/Transmitting ANI ID Code, ANI ID Code transmitting delay and DTMF Sidetone

#### **NOTE**

» The above functions in this transceiver only can be edited by our programming software.

#### Editing ANI ID Code

ANI ID Code can be made up by alphanum (A~D and 0~9) with 6 digits max.

#### Transmitting ANI ID Code 40

Turn this function ON means when press PTT key, the ANI ID Code will be transmitted automatically, while turning it OFF means manually transmitting.

#### ANI ID Code transmitting delay

The delay time for transmitting ANI ID Code means the time which the transceiver is automatically delayed transmitting ANI ID Code.

This delay time can be set 3 seconds max, total 30 levels with 100ms each.

#### DTMF Sidetone

DTMF sidetone means to turn ON/OFF the speaker when transmitting DTMF code, and get the corresponding DTMF tone.

#### There are 4 options on setting sidetone:

- ① Keypad Sidetone: Press keypad to turn on sidetone when transmitting.
- ② ANI-ID Code Sidetone: Transmit ANI ID Code to turn on sidetone.
- ③ Key Sidetone+ANI-ID Sidetone: Code to turn press keypad and transmit ANI ID Code can turn on sidetone when transmitting.
- ④ OFF: In encoding mode, all sidetones are off.

## How to operate

### Setting priority scan function

If you want to monitor the other frequency and check the certain preferred frequency at the same time, you can set priority scan function.

**E.g.:** Scan six channels: Set CH1, CH2, CH3, CH4 and CH5 as the common scanned channels, and CH6 as the priority scanned channel. then the scanning order is as followings:

CH1 – CH6 – CH2 – CH6 – CH3 – CH6 – CH4 – CH6 – CH5 – CH6

When this transceiver detects signal on the priority channel when scanning, it will call on its frequency. Please program the priority channel via KG-UVD1P programming software.

### Setting reverse frequency function

When using the reverse frequency function, the transmitting and receiving frequencies of this transceiver will be interchanged, together with all settings for CTCSS/DCS and DTMF setting.

#### How to set the reverse frequency:

In standby mode, press **SCAN\*** to activated this function, while press **SCAN\*** again to switch it off.

### In channel mode, if you want to:

1. unlock the menu setting.
2. reset the transceiver.

please program above operations via Wouxun KG-UVD1P programming software.

### Low voltage prompt

When the batterypack is in low voltage, there will be voice prompt for the lower voltage, at this time, the backlight flashes one time every five seconds and the transceiver sounds out "click" to remind of being charged timely.

### Transmitting overtime prompt

When the transmitting time is exceeding the preset time, there will be an alarm to remind of the overtime transmitting, and the transmitting will be paused. If you want to continue transmitting, please press PTT to resume transmitting. (Please see MENU 15 about the Time-out timer TOT)

### Adding scanning channel

#### NOTE

- » Only the added scanning channel can be listed to scan.
- » Editing method: Strictly via KG-UVD1P programming software.

## How to operate

### Wire-clone function

|                    |   |  |
|--------------------|---|--|
| Wire-clone setting | a. Install battery packs on source radio and target radio and connect them via wire-clone cable.<br>b. And then power target radio on.<br>c. Power on the source radio and hold on the MONI key at the same time.<br>d. Red LED on the source radio flashes, while the green LED on the target radio flashes, it shows the wire cloning is completely proceeding. | Transmitting red LED flashing means transmitting data when wire cloning. Transmitting red LED distinguishes after completing wire-clone, and the transceiver returns to standby. Transmitting red LED lasting flashing means the wire-clone is failed and the transceiver returns to standby mode. |
|                    | Target radio  | Receiving green LED flashing means receiving data when wire cloning. Receiving green LED extinguishes after completing wire-clone, and the transceiver returns to standby.   |

### Working with Repeater

Most repeaters are working in the Dis-channel mode, which the receiving frequency and the transmitting frequency are offset working. Meanwhile, the frequencies with the repeater working are set with the matching CTCSS/DCS.

44

There are two working mode setting when programming the transceiver to work with the repeater:

#### 1. Work with repeater in frequency mode

- ① Press **A/B** to choose band A, set the desired transmitting frequency and the matching CTCSS/DCS.
- ② Press **A/B** to choose band B, set the desired receiving frequency and the matching CTCSS/DCS.
- ③ Press **MENU** + **TDR**, the arrow points at band A, and the setting to work with repeater in frequency mode is done.

#### 2. Work with repeater in channel mode

- ① Separately set the transmitting and receiving frequencies, together with the matching CTCSS/DCS setting, and store them into the desired channel as the dis-channel memory.
- ② Set the channel mode as the working mode. Press **A/B** to set this channel as the current transmitting/receiving channel, and working with repeater in channel mode is set.

### How to use the intelligent charger

1. Insert the AC plug into the power grid socket (AC:90-240V), the indicator on the charger flashes, then the charger is in the charging standby mode.
2. Insert the battery into the charger, the RED LED is on, which means charging is on the progress. When the RED LED turns to GREEN, the charging completes.

45

## How to operate

### NOTE

- » When the exhausted battery pack is inserted into the charger, it will be pre-charged in trickle power with the RED LED flashing until 10-20 minutes later. Then the RED LED is on, the charger enters into the normal charging mode. When the GREEN LED turns on, it is fully charged.
- » Charging the exhausted battery pack in trickle power can protect the lithium battery pack better.

### **Programming guide for KG-UVD1P software (via USB programming cable)**

- a. Download, unzip and install the USB driver according to different operating system.
- b. Restart your computer, and it shows the driver is installed successfully.
- c. Download and unzip the matching programming software.
- d. Connect the transceiver and open the software.
- e. Power on the transceiver and open the software.
- f. Read from the radio to check the connection.
- g. Set the parameter and functions accordingly.
- h. Write to the radio.

### NOTE

- » If you get the message "failed connection" when you try to read from the radio, please check the first five steps and the communication ports accordingly.
- » Please note that once the first three steps are done well, the com port will be selected automatically when you open the software. However, according to the different computer settings, the com port may be needed to re-set.
- » Please determine the port assignment from the device manager of the computer and select the correct communication port, which is available for the connection.
- » If the connection is still not OK, please try another cable or another transceiver on another computer to double check. Please refer to the detailed manual or the video guide for KG-UVD1P programming on our wouxun website: <http://www.wouxun.com>

## Trouble shooting

Before the transceiver is regarded as being faulty, please double check according to the main problems as following chart. If the problems are still happening, please reset it to avoid some misfunctional operation, search assistance from the experienced technician or contact your buyer accordingly.

| <b>Problem</b>  | <b>Solution</b>   |
|---|---|
| The transceiver can not be powered on.                                | <ol style="list-style-type: none"> <li>1. The battery may be exhausted, pls change the new battery or re-charge it.</li> <li>2. The battery was not installed correctly, pls re-install.</li> </ol> |
| The battery life is too short to use.                                 | <ol style="list-style-type: none"> <li>1. The battery life is over, pls change a new battery.</li> <li>2. The battery is not fully charge.</li> </ol>   |
| The receiving light keeps flashing, but there is no sound coming out. | <ol style="list-style-type: none"> <li>1. Make sure the volume is highest.</li> <li>2. Make sure the CTCSS/DCS settings are the same as the transmitting transceiver.</li> </ol>                    |
| It seems the keyboard does not work.                                  | <ol style="list-style-type: none"> <li>1. Make sure the keypad is locked or not.</li> <li>2. Make sure the keys are not stuck.</li> </ol>   |

48

| <b>Problem</b>  | <b>Solution</b>   |
|---|---|
| In standby, the transceiver will transmit automatically even the PTT key is not pressed | Make sure VOX function is ON or not, and its level is set too low or not.   |
| Some functions can not be stored normally.  | Please confirm if the transceiver is working in channel mode, since some functions are ONLY set in frequency mode via programming software. |
| There are other disturbed signals or noise( from other groups) in the channel.          | Please change the CTCSS/DCS frequencies set in your group.  |

49

## Technical parameter

### Appendix 1

#### CTCSS

|    |      |    |       |    |       |    |       |    |       |
|----|------|----|-------|----|-------|----|-------|----|-------|
| 1  | 67.0 | 11 | 94.8  | 21 | 131.8 | 31 | 171.3 | 41 | 203.5 |
| 2  | 69.3 | 12 | 97.4  | 22 | 136.5 | 32 | 173.8 | 42 | 206.5 |
| 3  | 71.9 | 13 | 100.0 | 23 | 141.3 | 33 | 177.3 | 43 | 210.7 |
| 4  | 74.4 | 14 | 103.5 | 24 | 146.2 | 34 | 179.9 | 44 | 218.1 |
| 5  | 77.0 | 15 | 107.2 | 25 | 151.4 | 35 | 183.5 | 45 | 225.7 |
| 6  | 79.7 | 16 | 110.9 | 26 | 156.7 | 36 | 186.2 | 46 | 229.1 |
| 7  | 82.5 | 17 | 114.8 | 27 | 159.8 | 37 | 189.9 | 47 | 233.6 |
| 8  | 85.4 | 18 | 118.8 | 28 | 162.2 | 38 | 192.8 | 48 | 241.8 |
| 9  | 88.5 | 19 | 123.0 | 29 | 165.5 | 39 | 196.6 | 49 | 250.3 |
| 10 | 91.5 | 20 | 127.3 | 30 | 167.9 | 40 | 199.5 | 50 | 254.1 |

### Appendix 2

#### DCS

|    |       |    |       |    |       |    |       |    |       |
|----|-------|----|-------|----|-------|----|-------|----|-------|
| 1  | D023N | 16 | D074N | 31 | D165N | 46 | D261N | 61 | D356N |
| 2  | D025N | 17 | D114N | 32 | D172N | 47 | D263N | 62 | D364N |
| 3  | D026N | 18 | D115N | 33 | D174N | 48 | D265N | 63 | D365N |
| 4  | D031N | 19 | D116N | 34 | D205N | 49 | D266N | 64 | D371N |
| 5  | D032N | 20 | D122N | 35 | D212N | 50 | D271N | 65 | D411N |
| 6  | D036N | 21 | D125N | 36 | D223N | 51 | D274N | 66 | D412N |
| 7  | D043N | 22 | D131N | 37 | D225N | 52 | D306N | 67 | D413N |
| 8  | D047N | 23 | D132N | 38 | D226N | 53 | D311N | 68 | D423N |
| 9  | D051N | 24 | D134N | 39 | D243N | 54 | D315N | 69 | D431N |
| 10 | D053N | 25 | D143N | 40 | D244N | 55 | D325N | 70 | D432N |
| 11 | D054N | 26 | D145N | 41 | D245N | 56 | D331N | 71 | D445N |
| 12 | D065N | 27 | D152N | 42 | D246N | 57 | D332N | 72 | D446N |
| 13 | D071N | 28 | D155N | 43 | D251N | 58 | D343N | 73 | D452N |
| 14 | D072N | 29 | D156N | 44 | D252N | 59 | D346N | 74 | D454N |
| 15 | D073N | 30 | D162N | 45 | D255N | 60 | D351N | 75 | D455N |



## Technical parameter

| DCS |       |    |       |    |       |    |       |     |       |
|-----|-------|----|-------|----|-------|----|-------|-----|-------|
| 76  | D462N | 82 | D516N | 88 | D606N | 94 | D645N | 100 | D723N |
| 77  | D464N | 83 | D523N | 89 | D612N | 95 | D654N | 101 | D731N |
| 78  | D465N | 84 | D526N | 90 | D624N | 96 | D662N | 102 | D732N |
| 79  | D466N | 85 | D532N | 91 | D627N | 97 | D664N | 103 | D734N |
| 80  | D503N | 86 | D546N | 92 | D631N | 98 | D703N | 104 | D743N |
| 81  | D506N | 87 | D565N | 93 | D632N | 99 | D712N | 105 | D754N |

52

## Technical specification

**Wouxun**  
Professional FM Transceiver

|  |   |   |
|--|---|---|
| Frequency Range<br>(can be suitable for different countries or areas): | 76-108 MHz (Rx)<br>136-174MHz & 350-470MHz (Rx / Tx),<br>136-174MHz & 420-520MHz (Rx / Tx),<br>136-174MHz & 245-250MHz (Rx / Tx),<br>136-174MHz & 225-226MHz (Rx / Tx),<br>66-88MHz & 400-480MHz (Rx / Tx). | 136-174MHz & 400-480MHz (Rx / Tx),<br>136-174MHz & 400-470MHz (Rx / Tx),<br>136-174MHz & 216-280MHz (Rx / Tx),<br>144-146MHz & 430-440MHz (Rx / Tx).! |
| Memory channel   | 128 channels  |   |
| Operating Voltage  | 7.4V  |   |
| Operating Temperature  | -30°C to + 60°C   |   |
| Working Mode   | Co-channel or Dis-channel simplex   |   |
| Output Power   | VHF: 5W / UHF:4W  |   |
| Modulation   | F3E(FM)   |   |
| Max. Frequency Deviation   | ≤ ±5KHz   |   |
| Spurious Radiation   | < -60dB   |   |
| Frequency Stability  | ±2.5 ppm  |   |
| Receive Sensitivity  | < 0.2 μV  |   |
| Audio Output power   | ≥ 500mW   |   |
| Dimension  | 58 X 105 X 38 (mm)  |   |
| Weight   | 250g  |   |

### NOTE

» Specifications is subject to be updated without prior notice.

53

## Optional accessories

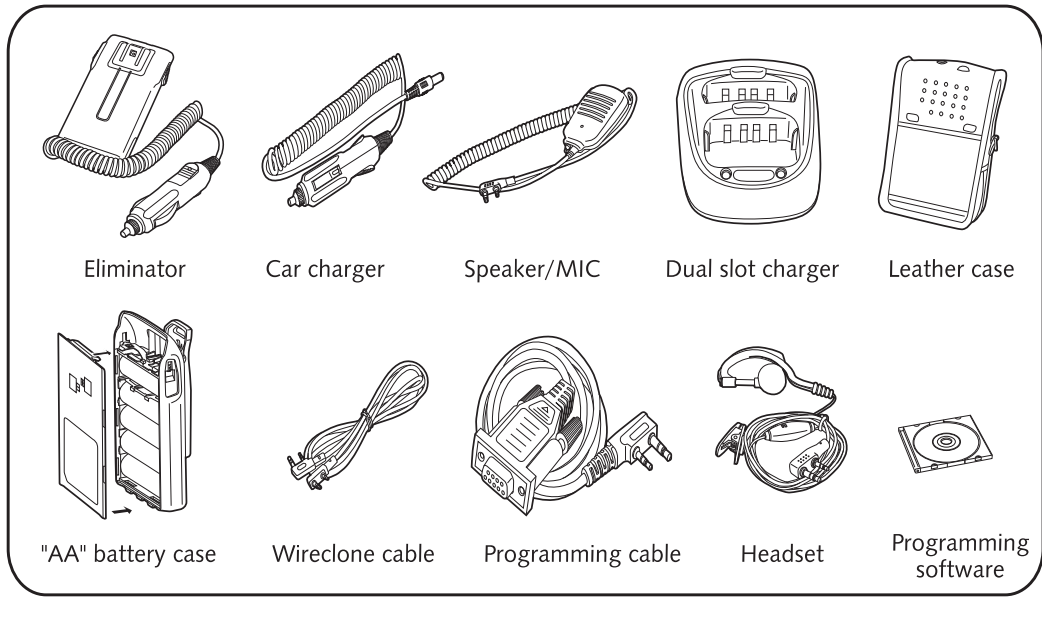

54

## Announcement

**Wouxun**  
Professional FM Transceiver

**Wouxun** endeavors to achieve the accuracy and completeness of this manual, but it is still not perfect for any possible omissions or printing errors. All the above is subject to be updated without prior notice.

English Version: 1012-V4

55

## DECLARATION OF CONFORMITY

We, Quanzhou Wouxun Electronics Co., Ltd.  
No.928 Nanhuan Road, Jiangnan High Technology Industry park, Quanzhou,  
Fujian 362000, China,

declare that our product:

Product Description: Two-way Radio  
Brand: WOUXUN  
Model: KG-UVD1P

is in compliance with the essential requirements and other relevant provisions  
of the R&TTE directive 1999/5/EC and carries the CE mark accordingly.

Supplementary information:

The product complies with the requirements of:

Low Voltage Directive 2006/95/EC  
-EN 60950-1: 2006+A11:2009

Efficient use of frequency spectrum  
-ETSI EN 301783-1 V1.1.1(2008-09)  
-ETSI EN 301783-2 V1.1.1 (2008-09)

EMC Directive 2004/108/EC  
-ETSI EN 301 489-1 V1.8.1 (2008-04)  
-ETSI EN 301 489-15 V1.2.1 (2002-08)

Date: June 16, 2010

Place: Quanzhou, Fujian, China

Name: Danny Chen

Signature: *Danny Chen*

Quanzhou Wouxun Electronics Co., Ltd.  
park, Quanzhou, Fujian 362000, China  
Tel: +86 595 28051265 Fax: +86 595 28051267  
Http://www.wouxun.com

## National model approval certification

**wouxun**  
Professional FM Transceiver

**无线电发射设备**  
Radio Transmission Equipment  
**型号核准证**  
Type Approval Certificate

泉州欣讯电子有限公司:  
根据《中华人民共和国无线电管理条例》, 经审查, 下列无线电发射设备符合中华人民共和国无线电管理规定和技术标准, 其核准代码为: CMIIT ID: 2009FP5789 to the provisions with its CMIIT ID:

有效期: 五年  
Validity

Sealed by Issuing Authority  
2009年12月24日  
Year Month Date

编号: 2009-5789  
Number

设备名称: 调频手持台  
Equipment Name

设备型号: KG-UVD1P  
Equipment Type

主要功能: 语音通信  
Main Functions

调制方式: FM  
Modulation Mode

主要技术参数及其指标值:  
Main Technical Parameters

频率范围: 138-167MHz 403-404.5MHz 410-420MHz 450-470MHz  
Frequency Range

频率容限: <15ppm <7ppm  
Frequency Tolerance

发射功率: <5W  
Transmitting Power

占用带宽: <16kHz  
Occupied Bandwidth

杂散发射限值: <7.5μV  
Spurious Emission Limits

Sealed by Issuing Authority  
2009年12月24日  
Year Month Date

1st National Approval Certification for Dual Band Two Way Radio

KG-UVD1P Approval Code: CMIIT ID: 2009FP5789