

FT-470

TECHNICAL SUPPLEMENT



YAESU MUSEN CO.,LTD.
C.P.O.BOX 1500, TOKYO. JAPAN

YAESU U.S.A.
17210 Edwards Rd. Cerritos, California, 90701 U.S.A.

YAESU EUROPE B.V.
Snipweg 3. 1118AA Schiphol The NETHERLANDS

This manual is intended to serve as a supplement to the FT-470 Operating Manual. Specifications and details of operation and options are provided in the Operating Manual, and are not reprinted herein. Therefore, this manual is not intended to serve as an independent reference, but to be used in conjunction with the information provided in the Operating Manual.

Two layout diagrams are provided for each double-sided glass-epoxy circuit board in the FT-470. Each side of the board is identified by the type of the majority of components installed on that side. In most cases one side has only chip components, and the other has either a mixture of both chip and lead components (trimmers, coils, electrolytic capacitors, packaged ICs, etc.), or leaded components only.

While we believe the technical information in this manual is correct, Yaesu assumes no liability for damage that may occur as a result of typographical or other errors that may be present. Your cooperation in pointing out any inconsistencies in the technical information would be appreciated.

Yaesu Musen reserves the right to make changes in the circuitry of this transceiver, in the interest of technological improvement, without notification of the owners.

CONTENTS

SPECIFICATIONS	1
CIRCUIT BOARD ACCESS	2
EXPLODED VIEW	3
CHIP COMPONENT INFORMATION	4
CONTROL UNIT PARTS LAYOUT	7
CONTROL UNIT CIRCUIT DIAGRAM	9
CONTROL UNIT PARTS LIST	10
RF UNIT PARTS LAYOUT	14
RF UNIT CIRCUIT DIAGRAM	16
RF UNIT PARTS LIST	17
VHF PLL UNIT PARTS LAYOUT/CIRCUIT DIAGRAM	24
VHF PLL UNIT PARTS LIST	25
UHF PLL UNIT PARTS LAYOUT/CIRCUIT DIAGRAM	26
UHF PLL UNIT PARTS LIST	27
ANT SW UNIT	29
IF, CONNECTOR UNIT PARTS LAYOUT	30
IF, CONNECTOR UNIT CIRCUIT DIAGRAM	32
IF, CONNECTOR UNIT PARTS LIST	33
T-BURST UNIT (Version B, Only)	37
BLOCK DIAGRAM	39
ALIGNMENT	40
ALIGNMENT (VHF PLL & Transmitter)	41
ALIGNMENT (VHF Receiver)	42
ALIGNMENT (UHF PLL & Transmitter)	43
ALIGNMENT (UHF Receiver)	44

SPECIFICATIONS

RECEIVER

Circuit type:

Double-conversion superhet

Sensitivity (for 12dB SINAD):

better than 0.158uV (-10dBu)

Adjacent channel selectivity:

better than 60dB

Intermodulation:

better than 65dB

Audio output:

0.5W @8 ohms for 5% THD (12V)

TRANSMITTER

Power output:

(see RF Power Chart)

Frequency stability:

better than ± 5 ppm (-5 to +60°C)

Modulation system:

variable reactance

Maximum deviation:

± 5 kHz

FM Noise:

better than -40dB @ 1 kHz

Spurious emissions:

better than 60dB below carrier

Audio distortion (@ 1 kHz):

less than 5%, w/3 kHz deviation

Microphone type:

2-kilohm condenser

Burst tone:

1750 Hz (except versions A & H)

GENERAL

Frequency coverage (MHz):

see Version Chart

Channel steps:

5, 10, 12.5, 20 & 25 kHz

Standard repeater shift:

see Version Chart

Emission type:

G3E

Supply voltage:

5.5 to 15.0 VDC

Current consumption (single band):

Standby (1 sec. Save) 8mA;

Receive: 150mA;

Transmit (5W): 1300/1600 mA
(VHF/UHF);

Auto Power Off: 7 mA

Antenna (BNC jack):

YHA-28 rubber flex antenna

Case size (WHD):

55x147x32mm w/FNB-/FBA-9

55x164x32mm w/FNB-/FBA-10

55x213x32mm w/FNB-11

55x180x32mm w/FNB-12/-14

55x152x32mm w/FNB-/FBA-17

Weight (approx):

420g w/FNB-10, 540g w/FNB-11

Version Chart

Version	A	B	C	H
VHF: 144-146 144-148		X	X	X
UHF: 430-440 430-450	X	X	X	X
UHF Std. Split	5	7.6	1.6	5

RF Power Chart

Battery Type	RF Output(W)	
	VHF	UHF
(Dry Cell Cases)		
FBA-9 (6xAAA cells)	1.5	1.0
FBA-10/17 (6xAA cells)	2.0	1.5
(Ni-Cd Packs)		
FNB-9 (7.2V/200 mAh)	2.0	1.5
FNB-10/17 (7.2V/600mAh)	2.3	2.3
FNB-11 (12V/600 mAh)	5.0	5.0
FNB-12 (12V/500 mAh)	5.0	5.0
FNB-14 (7.2V/1000mAh)	2.3	2.3

CIRCUIT BOARD ACCESS

- 1) Make sure the transceiver is off. Remove the hard or soft case, if used, and remove the battery pack. Also remove the antenna.
- 2) Remove the four screws affixing the battery spring plate on the bottom of the transceiver, and carefully remove the plate and the battery release button.

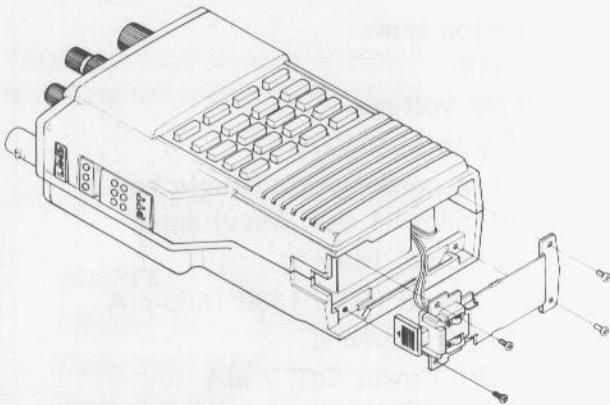

- 3) Pull off the four knobs on the top panel, and the EAR/MIC gasket from the antenna jack. Remove the four screws affixing the panel and carefully remove it and the rubber gasket underneath.

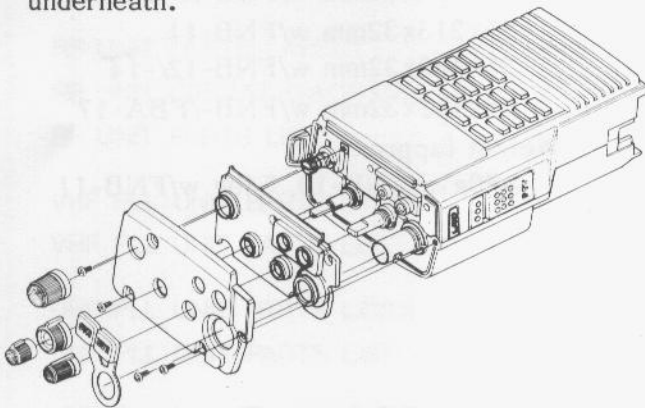

- 4) Remove the three screws affixing the front and rear halves of the case, and slowly separate the halves, using care not to stress the inter-connecting cable.

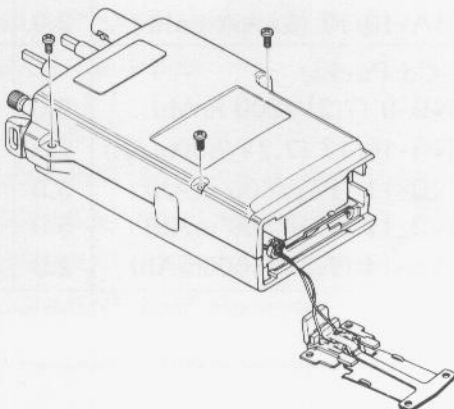

To separate the front and rear halves of the chassis, use a small screwdriver to pry up one side of the connector on the "rear panel end" of the flat cable (see inset in diagram below), and then gently pull the cable out of the connector.

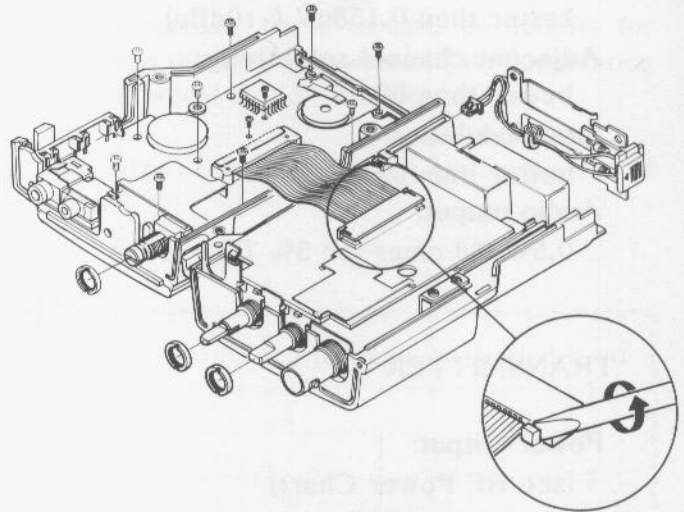

To remove the Control Unit from the front half of the chassis, loosen the ring nut around the DIAL shaft, and then remove the eleven screws indicated in the diagram above.

To remove the IF Unit from the rear half of the chassis, loosen the ring nuts around the VOL/BAL and SQL controls, and gently pry the board up so that it unplugs from the Mother Board Unit.

To remove the Mother Board Unit, after removing the IF Unit, loosen the ring nut around the ANT jack remove the eight screws indicated below.

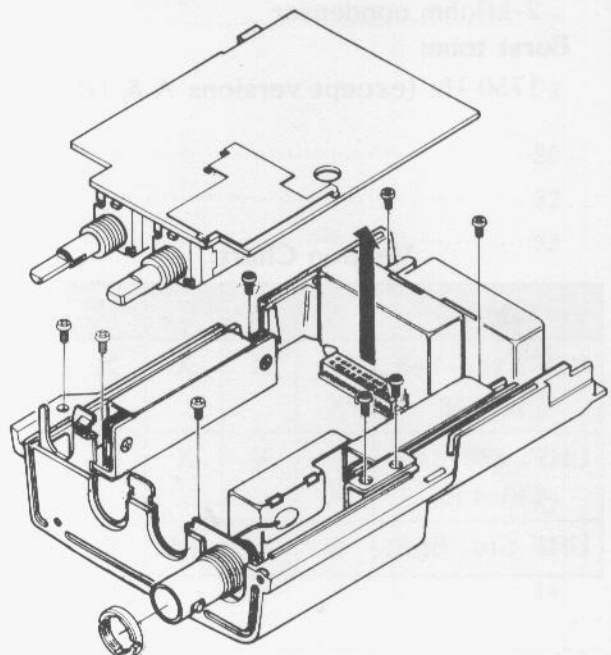

EXPLODED VIEW

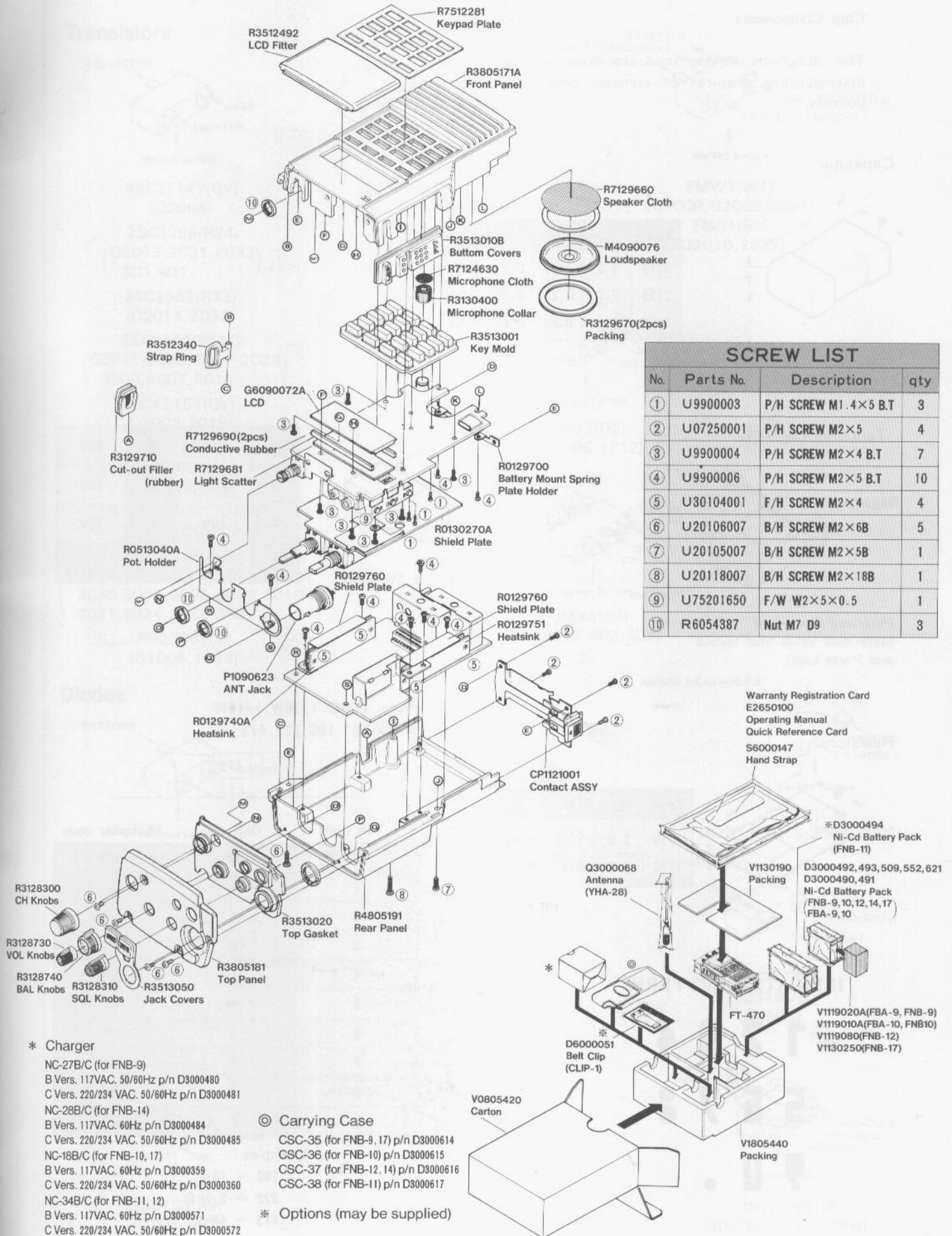

CHIP COMPONENT INFORMATION

Chip Components

The diagrams below indicate some of the distinguishing features of common chip components.

Capacitor

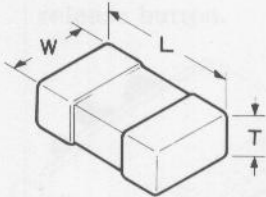

(Unit : mm)

Type	L	W	T
3216	3.2	1.6	0.45~0.60
2125	2.0	1.25	0.35~0.50
1608	1.6	0.8	0.65~0.95

Tantalum Capacitor

Negative

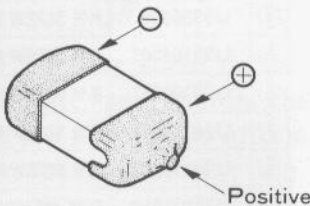

Positive

Polarized, Unmarked
(determine value from layout
and Parts List)

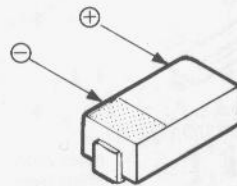

Examples :
J475 = 6.3V 4.7 μ F

G	4.0V	D	20V
J	6.3V	E	25V
A	10V	V	35V
C	16V		

Resistors

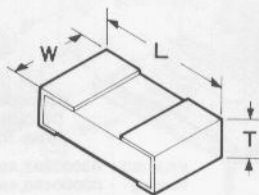

(Unit : mm)

Type	L	W	T
1/10	2.0	1.25	0.45
1/16	1.6	0.8	0.45

Type RMC 1/10W, 1/16W
Marking* 100, 222, 473.....

473		
Ten unit	One unit	Multiplier code
0	0	10 ⁰
1	1	10 ¹
2	2	10 ²
3	3	10 ³
4	4	10 ⁴
5	5	10 ⁵
6	6	10 ⁶
7	7	10 ⁷
8	8	10 ⁸
9	9	10 ⁹

INDICATED LETTERS

1 2 3 4
5 6 7 :
9 0 .

Examples :

100 = 10 Ω
222 = 2.2k Ω
473 = 47k Ω

CHIP COMPONENT INFORMATION

Transistors

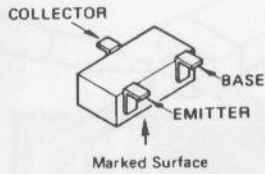

2SC2714Y(QY)
(Q2004)

2SC3356(R24)
(Q2013, 2031, 2033)
301, 401

2SC3583(R32)
(Q2014, 2032)

2SC4116GR(LG)
(Q2011, 2023, 2027, 2028)
3003, 3007, 3010

2SC4215Y(QY)
(Q2003, 2015)

2SC4245(HB)
(Q2002)

DTA123YU(52)
(Q3013, 3014, 3016)
3019, 3020, 3022

RN1303(XC)
(Q1014, 2007, 2025, 2026, 2029)
2030, 3002, 3006, 3015, 3018
3021, 3024, 3025, 3027

RN2303(YC)
(Q1005, 1013)

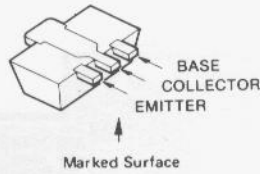

2SB799(ML)

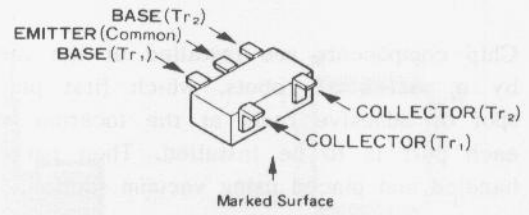

FMW1(W1)
(Q1009, Q2009, 2021)
FMS1(S1)
(Q2010, 2022)

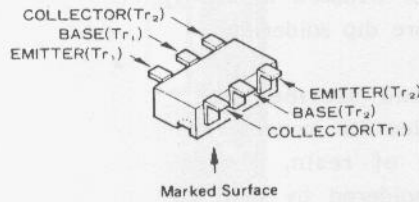

IMD2(D2)
(Q1006, 1012)

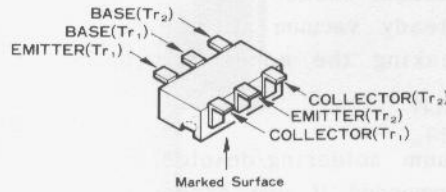

IMX5(X5)
(Q2001, 302, 402)

Diodes

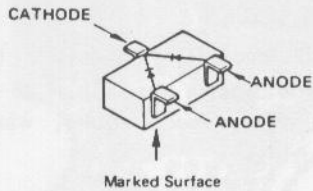

1SS184(B3)
(2003, 1101)

1SS301(B3)
(D1005, 2002, 2006, 2008, 2011)
2013, 2014, 2017, 2018, 3003
3004, 3005, 3007, 3008, 3010
3011, 3012, 3013, 3014, 3015

1SS321(F9)
(D2005, 503)

DAN235K(M)
(Q2009)

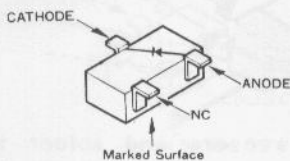

1SS153(A9)
(D304, 403)

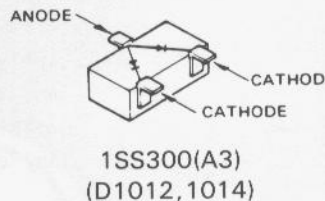

1SS300(A3)
(D1012, 1014)

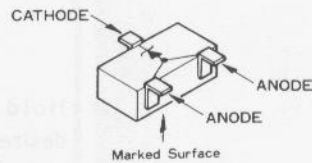

HZM11A(28)
(Q3009)

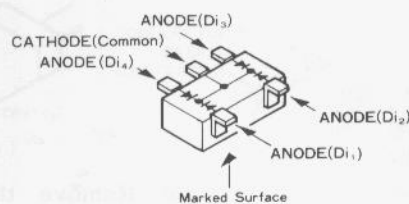

FMN1(N1)
(D1001, 1007)

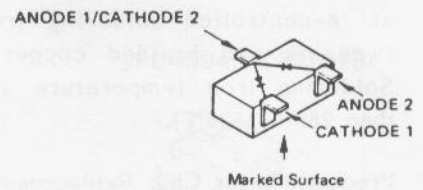

1SS302(C3)
(D1013, 2015, 3002, 3006)

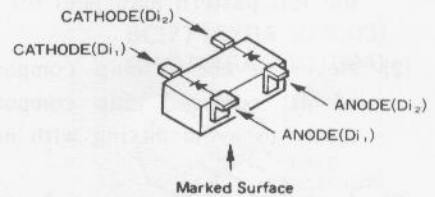

1SS319(A4)
(D1006)

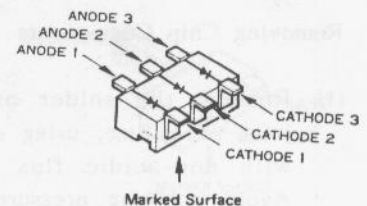

IMN10(N10)
(D1002, 1003, 1004)

CHIP COMPONENT INFORMATION

Replacing Chip Components

Chip components are installed at the factory by a series of robots, which first place a spot of adhesive resin at the location where each part is to be installed. Then parts are handled and placed using vacuum suction.

For single-sided boards, solder paste is applied and the board is then baked to harden the resin and flow the solder. For double-sided boards, no solder paste is applied, but the board is baked (or exposed to ultraviolet) to cure the resin before dip soldering.

In our laboratory and service shop, chip parts in small quantities are mounted manually by applying a spot of resin, placing with tweezers, and then soldered by dual streams of hot air (without physical contact during soldering). We remove parts by first removing solder using a vacuum suction iron, which applies a light steady vacuum at the iron tip, and then breaking the adhesive with tweezers.

The special vacuum soldering/desoldering equipment is recommended if you expect to do a lot of chip replacements. Otherwise, it is usually possible to remove and replace chip components with only a tapered, temperature-controlled soldering iron, a set of tweezers and braided copper solder wick. Soldering iron temperature should be less than 280°C (536°F).

Precautions for Chip Replacement

- (1) Do not disconnect a chip forcefully, or the foil pattern may peel off the board.
- (2) Never re-use a chip component. Dispose of all removed chip components immediately to avoid mixing with new parts.
- (3) Limit soldering time to 3 seconds or less to avoid damaging the component and board.

Removing Chip Components

- (1) Remove the solder at each joint, one joint at a time, using solder wick wetted with non-acidic flux as shown below. Avoid applying pressure, and do not attempt to remove the tinning from the chip's electrode.

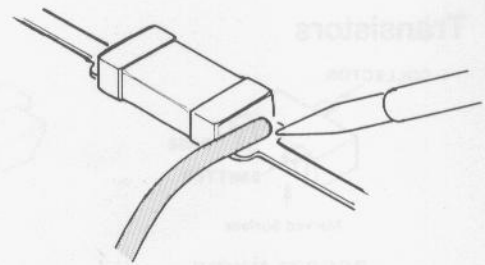

- (2) Grasp the chip on both sides with tweezers, and gently twist the tweezers back and forth (to break the adhesive bond) while alternately heating each electrode. Be careful to avoid peeling the foil traces from the board. Dispose of the chip when removed.

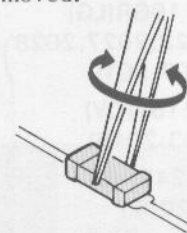

- (3) After removing the chip, use the copper braid and soldering iron to wick away any excess solder and smooth the land for installation of the replacement part.

Installing a Replacement Chip

As the value of some chip components is not indicated on the body of the chip, be careful to get the right part for replacement.

- (1) Apply a small amount of solder to the land on one side where the chip is to be installed. Avoid too much solder, which may cause bridging.

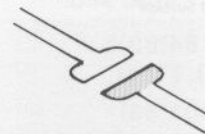

- (2) Hold the chip with tweezers in the desired position, and apply the soldering iron with a motion indicated by the arrow in the diagram below. Do not apply heat for more than 3 seconds.

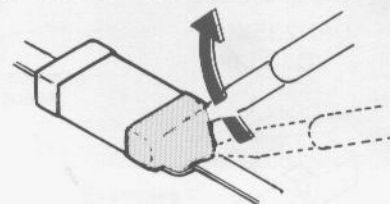

- (3) Remove the tweezers and solder the electrode on the other side in the manner just described.

CONTROL UNIT PARTS LAYOUT

CONTROL UNIT (No.10XX)

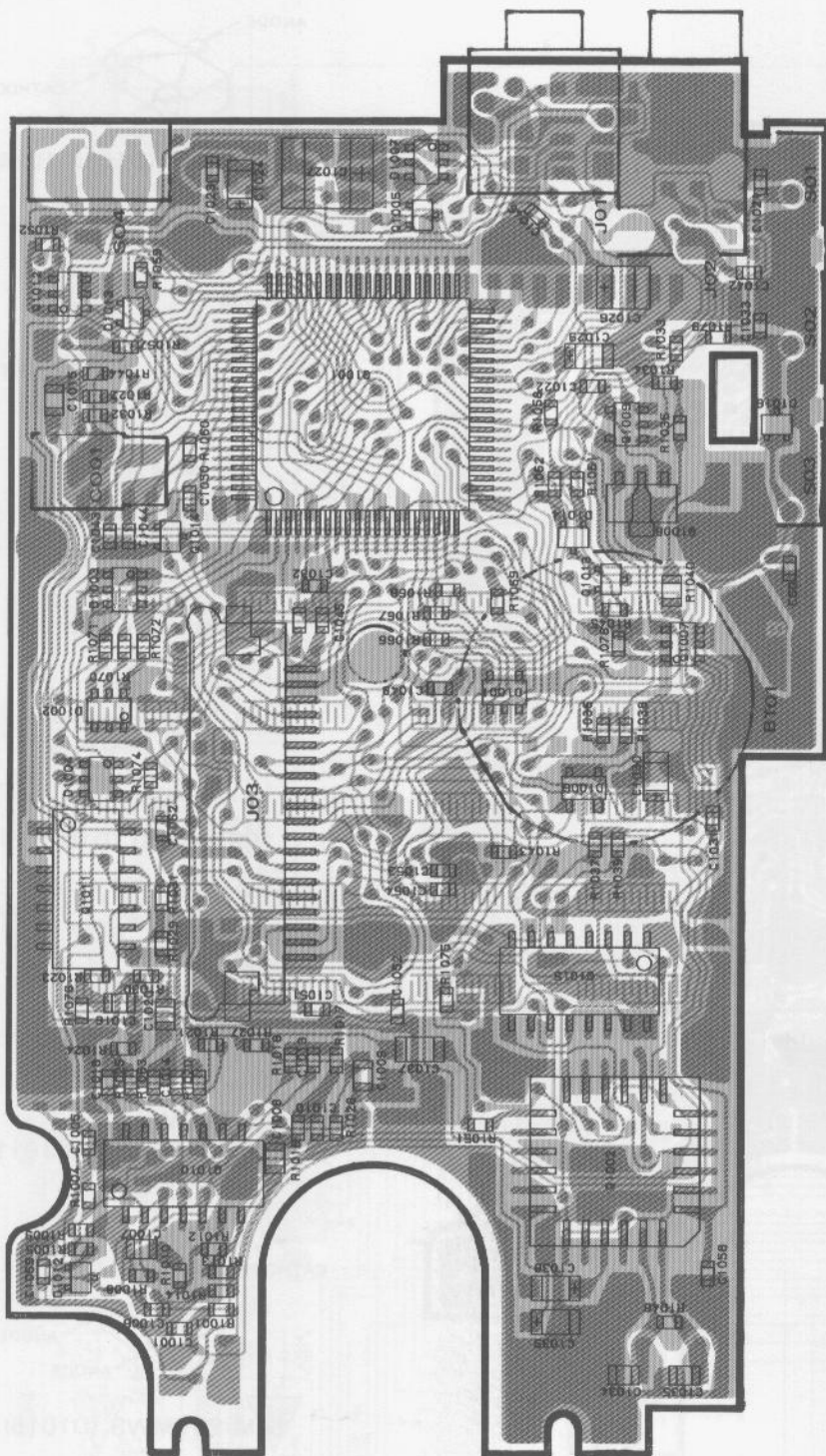

obverse view of "component" side

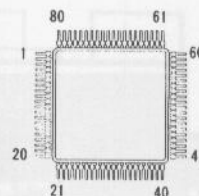

HD404608-A10H (Q1001)

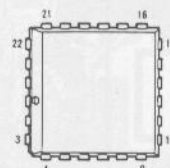

MX365LH (Q1002)

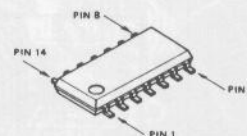

NJM2902M (Q1010)
μPD4013BG (Q1011)

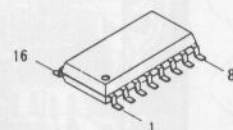

μPD4094BG (Q1015)

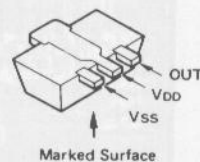

SCI7710YBA (Q1003)
RH5VA45AA (Q1004)



2SB799(ML) (Q1008)

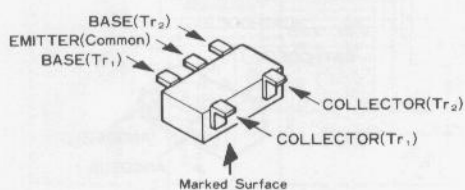

FMW1(W1) (Q1009)

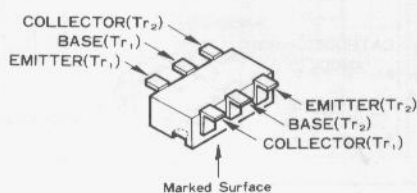

IMD2(D2) (Q1006, 1012)

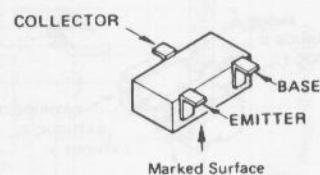

RN1303(XC) (Q1014)
RN2303(YC) (Q1005, 1013)

CONTROL UNIT PARTS LAYOUT

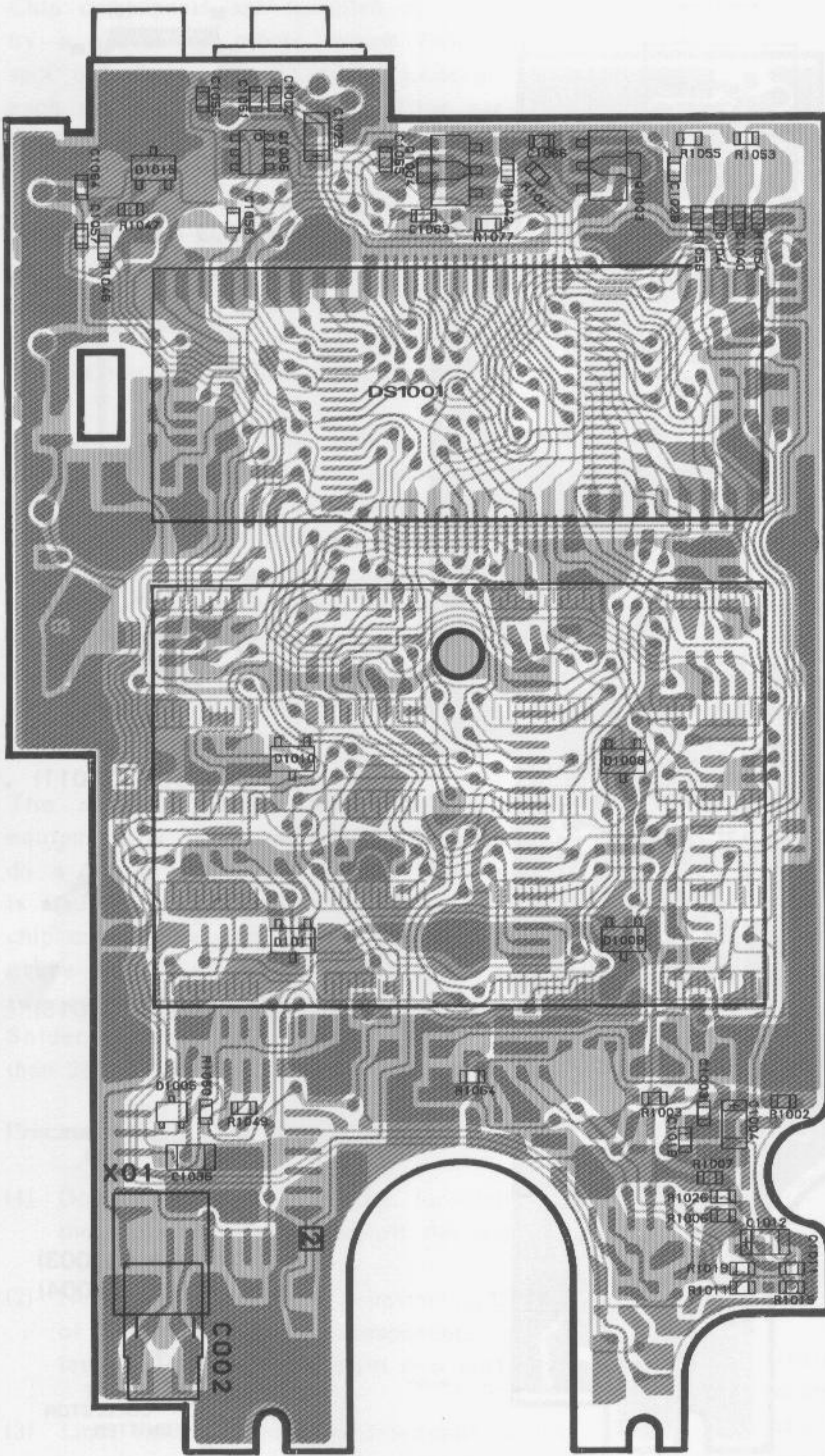

obverse view of "display" side

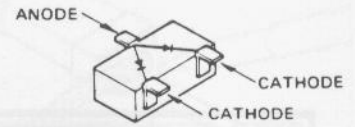

1SS300(A3) (D1012, 1014)

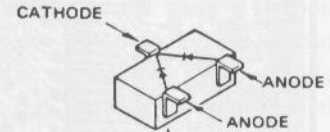

1SS301(B3) (D1005)

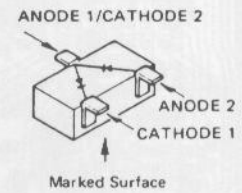

1SS302(C3) (D1013)

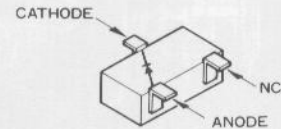

SLM-13MWS
(D1008, 1009, 1010, 1011)

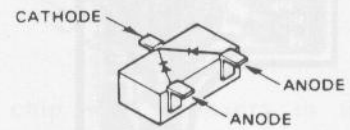

SLM-23VMWS (D1015)

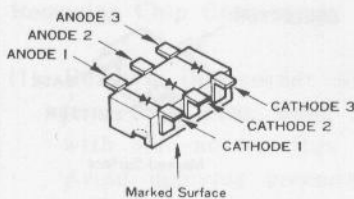

IMN10(N10)
(D1002, 1003, 1004)

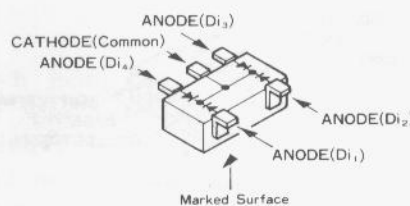

FMN1(N1) (D1001, 1007)

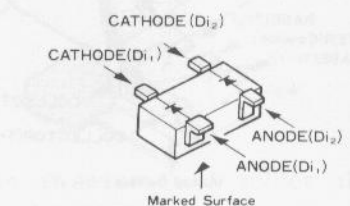

1SS319(A4) (D1006)

CONTROL UNIT PARTS LIST

ADD	CODE No.	DESCRIPTION	
CS0330001	PCB with Components W/Sub-units Ver. A1		
CS0330002	PCB with Components W/Sub-units Ver. A2		
CS0330003	PCB with Components W/Sub-units Ver. B1		
CS0330004	PCB with Components W/Sub-units Ver. C1		
CS0330005	PCB with Components W/Sub-units Ver. H1		
F30391013	Printed Circuit Board		
BT1001	Q9000446	LITHIUM BATTERY CR2025-TS1	CR2025-TS1
C 1001	K22174809	CHIP CAP. GRM39B102M50PT	0.001
C 1002	K22174809	CHIP CAP. GRM39B102M50PT	0.001
C 1003	K22174809	CHIP CAP. GRM39B102M50PT	0.001
C 1004	K78080017	CHIP TA. CAP. TEMSVA0J475M-8R	4.7 6.3V
C 1005	K22174817	CHIP CAP. GRM39B472M50PT	0.0047
C 1006	K22174809	CHIP CAP. GRM39B102M50PT	0.001
C 1007	K22120805	CHIP CAP. GRM40R683M16PT	0.068 16V
C 1008	K22120805	CHIP CAP. GRM40R683M16PT	0.068 16V
C 1009	K22120805	CHIP CAP. GRM40R683M16PT	0.068 16V
C 1010	K22144802	CHIP CAP. GRM39B103M25PT	0.01 25V
C 1011	K22174809	CHIP CAP. GRM39B102M50PT	0.001
C 1012	K78080017	CHIP TA. CAP. TEMSVA0J475M-8R	4.7 6.3V
C 1013	K22144802	CHIP CAP. GRM39B103M25PT	0.01 25V
C 1014	K22174809	CHIP CAP. GRM39B102M50PT	0.001
C 1015	K22174809	CHIP CAP. GRM39B102M50PT	0.001
C 1016	K22120805	CHIP CAP. GRM40R683M16PT	0.068 16V
C 1018	K22170805	CHIP CAP. GRM40B102M50PT	0.001
C 1019			
C 1020	K22120805	CHIP CAP. GRM40R683M16PT	0.068 16V
C 1021	K22174809	CHIP CAP. GRM39B102M50PT	0.001
C 1022	K22174809	CHIP CAP. GRM39B102M50PT	0.001
C 1023	K22174809	CHIP CAP. GRM39B102M50PT	0.001
C 1024	K78120009	CHIP TA. CAP. TESVA1C105M1-8R	1 16V
C 1025	K78140009	CHIP TA. CAP. TESVA1E474M1-8R	0.47 25V
C 1026	K78080019	CHIP TA. CAP. TEMSVB20J106M-8R	10 6.3V
C 1027	K78080012	CHIP TA. CAP. TESVD0J476M12R	47 6.3V
C 1028	K22174809	CHIP CAP. GRM39B102M50PT	0.001
C 1029	K78160028	CHIP TA. CAP. TESVA1V334M1-8R	0.33 35V
C 1030	K78080017	CHIP TA. CAP. TEMSVA0J475M-8R	4.7 6.3V
C 1031	K22174809	CHIP CAP. GRM39B102M50PT	0.001
C 1032	K22170805	CHIP CAP. GRM40B102M50PT	0.001
C 1033	K22174809	CHIP CAP. GRM39B102M50PT	0.001
C 1034	K22170223	CHIP CAP. GRM40CH330J50PT	33p
C 1035	K22170223	CHIP CAP. GRM40CH330J50PT	33p
C 1036	K22141809	CHIP CAP. GRM42-6B104M25PT	0.1 25V
C 1037	K22141809	CHIP CAP. GRM42-6B104M25PT	0.1 25V
C 1038	K78140009	CHIP TA. CAP. TESVA1E474M1-8R	0.47 25V
C 1039	K78120009	CHIP TA. CAP. TESVA1C105M1-8R	1 16V
C 1040	K22144802	CHIP CAP. GRM39B103M25PT	0.01 25V
C 1041	K22144802	CHIP CAP. GRM39B103M25PT	0.01 25V
C 1043	K22174235	CHIP CAP. GRM39CH101J50PT	100p
C 1044	K22174235	CHIP CAP. GRM39CH101J50PT	100p
C 1046	K22170235	CHIP CAP. GRM40CH101J50PT	100p
C 1050	K22170805	CHIP CAP. GRM40B102M50PT	0.001
C 1051	K22170227	CHIP CAP. GRM40CH470J50PT	47p
C 1052	K22170227	CHIP CAP. GRM40CH470J50PT	47p
C 1054	K22170235	CHIP CAP. GRM40CH101J50PT	100p
C 1055	K22170227	CHIP CAP. GRM40CH470J50PT	47p

CONTROL UNIT PARTS LIST

ADD	CODE No.	DESCRIPTION	
C 1056	K22170805	CHIP CAP. GRM40B102M50PT	0.001
C 1057	K22170805	CHIP CAP. GRM40B102M50PT	0.001
C 1060	K22174809	CHIP CAP. GRM39B102M50PT	0.001
C 1061	K22170805	CHIP CAP. GRM40B102M50PT	0.001
C 1062	K22170805	CHIP CAP. GRM40B102M50PT	0.001
C 1063	K22170817	CHIP CAP. GRM40B103M50PT	0.01
C 1064	K22170805	CHIP CAP. GRM40B102M50PT	0.001
C 1065	K22170227	CHIP CAP. GRM40CH470J50PT	47p
C 1066	K22170805	CHIP CAP. GRM40B102M50PT	0.001
CO1001	H7900530	CERAMIC OSC CSB800JT	CSB800JT
D 1001	G2070068	DIODE FMN1 T99	FMN1
D 1002	G2070078	DIODE IMN10 T108	IMN10
D 1003	G2070078	DIODE IMN10 T108	IMN10
D 1004	G2070078	DIODE IMN10 T108	IMN10
D 1005	G2070086	DIODE 1SS301 TE85R	1SS301
D 1006	G2070080	DIODE 1SS319 TE85R	1SS319
D 1007	G2070078	DIODE IMN10 T108	IMN10
D 1008	G2070098	LED SLM-13MWS T-97B	SLM-13MWS
D 1009	G2070098	LED SLM-13MWS T-97B	SLM-13MWS
D 1010	G2070098	LED SLM-13MWS T-97B	SLM-13MWS
D 1011	G2070098	LED SLM-13MWS T-97B	SLM-13MWS
D 1012	G2070084	DIODE 1SS300 TE85R	1SS300
D 1013	G2070088	DIODE 1SS302 TE85R	1SS302
D 1014	G2070084	DIODE 1SS300 TE85R	1SS300
D 1015	G2070096	LED SLM-23VMWS T-97B	SLM-23VMWS
DS1001	G6090072	LCD FTD-8973	FTD-8973
J 1001	P1090617	CONNECTOR HSJ1102-01-540	
J 1002	P1090370	CONNECTOR HSJ0836-01-010	
J 1003	P1090622	CONNECTOR 00 6200 207 032 800	
PL1001	Q1000060	LAMP KD-0001-01 6V 40MA	6V
Q 1001	G1090960	IC HD404608A10H	HD404608A10H
Q 1002	G1090897	IC MX365LH	MX365LH
Q 1003	G1090926	IC SCI7710YBA	SCI7710YBA
Q 1004	G1090922	IC RH5VA45AA-T2	RH5VA45AA
Q 1005	G3070036	TRANSISTOR RN2303 TE85R	RN2303
Q 1006	G3070026	TRANSISTOR IMD2 T108	IMD2
Q 1007	G3070026	TRANSISTOR IMD2 T108	IMD2
Q 1008	G3207997L	TRANSISTOR 2SB799-T2ML	2SB799 ML
Q 1009	G3070009	TRANSISTOR FMW1 T98	FMW1
Q 1010	G1090908	IC NJM2902M	NJM2902M
Q 1011			
Q 1012	G3070026	TRANSISTOR IMD2 T108	IMD2
Q 1013	G3070036	TRANSISTOR RN2303 TE85R	RN2303
Q 1014	G3070037	TRANSISTOR RN1303 TE85R	RN1303
Q 1015	G1090696	IC UPD4094BG	uPD4094BG
R 1001	J24185222	CHIP RES. RMC1/16 222JATP	2.2K
R 1002	J24185152	CHIP RES. RMC1/16 152JATP	1.5K
R 1003	J24185471	CHIP RES. RMC1/16 471JATP	470
R 1004	J24185562	CHIP RES. RMC1/16 562JATP	5.6K
R 1005	J24185223	CHIP RES. RMC1/16 223JATP	22K
R 1006	J24185472	CHIP RES. RMC1/16 472JATP	4.7K
R 1007	J24185563	CHIP RES. RMC1/16 563JATP	56K
R 1008	J24185474	CHIP RES. RMC1/16 474JATP	470K
R 1009	J24185103	CHIP RES. RMC1/16 103JATP	10K
R 1010	J24185103	CHIP RES. RMC1/16 103JATP	10K
R 1011	J24185225	CHIP RES. RMC1/16 225JATP	2.2M

CONTROL UNIT PARTS LIST

ADD	CODE No.	DESCRIPTION	
R 1012	J24185334	CHIP RES. RMC1/16 334JATP	330K
R 1013	J24185272	CHIP RES. RMC1/16 272JATP	2.7K
R 1014	J24185332	CHIP RES. RMC1/16 332JATP	3.3K
R 1015	J24185333	CHIP RES. RMC1/16 333JATP	33K
R 1016	J24185682	CHIP RES. RMC1/16 682JATP	6.8K
R 1017	J24185333	CHIP RES. RMC1/16 333JATP	33K
R 1018	J24185682	CHIP RES. RMC1/16 682JATP	6.8K
R 1019	J24185225	CHIP RES. RMC1/16 225JATP	2.2M
R 1020	J24185472	CHIP RES. RMC1/16 472JATP	4.7K
R 1021	J24185472	CHIP RES. RMC1/16 472JATP	4.7K
R 1022	J24185104	CHIP RES. RMC1/16 104JATP	100K
R 1023	J24205224	CHIP RES. RMC1/10T 224J	220K
R 1024	J24205154	CHIP RES. RMC1/10T 154J	150K
R 1025	J24205154	CHIP RES. RMC1/10T 154J	150K
R 1026	J24185225	CHIP RES. RMC1/16 225JATP	2.2M
R 1027	J24185333	CHIP RES. RMC1/16 333JATP	33K
R 1028	J24185103	CHIP RES. RMC1/16 103JATP	10K
R 1029	J24185472	CHIP RES. RMC1/16 472JATP	4.7K
R 1030	J24185333	CHIP RES. RMC1/16 333JATP	33K
R 1031	J24185563	CHIP RES. RMC1/16 563JATP	56K
R 1032	J24185103	CHIP RES. RMC1/16 103JATP	10K
R 1033	J24185222	CHIP RES. RMC1/16 222JATP	2.2K
R 1034	J24185472	CHIP RES. RMC1/16 472JATP	4.7K
R 1035	J24185102	CHIP RES. RMC1/16 102JATP	1K
R 1036	J24185471	CHIP RES. RMC1/16 471JATP	470
R 1037	J24185471	CHIP RES. RMC1/16 471JATP	470
R 1038	J24185471	CHIP RES. RMC1/16 471JATP	470
R 1039	J24185471	CHIP RES. RMC1/16 471JATP	470
R 1040	J24205390	CHIP RES. RMC1/10T 390J	39
R 1041	J24185472	CHIP RES. RMC1/16 472JATP	4.7K
R 1042	J24185104	CHIP RES. RMC1/16 104JATP	100K
R 1043	J24185472	CHIP RES. RMC1/16 472JATP	4.7K
R 1044	J24185104	CHIP RES. RMC1/16 104JATP	100K
R 1045	J24185332	CHIP RES. RMC1/16 332JATP	3.3K
R 1046	J24185471	CHIP RES. RMC1/16 471JATP	470
R 1047	J24185102	CHIP RES. RMC1/16 102JATP	1K
R 1048	J24185105	CHIP RES. RMC1/16 105JATP	1M
R 1049	J24185225	CHIP RES. RMC1/16 225JATP	2.2M
R 1050	J24185334	CHIP RES. RMC1/16 334JATP	330K
R 1051	J24185273	CHIP RES. RMC1/16 273JATP	27K
R 1052	J24185104	CHIP RES. RMC1/16 104JATP	100K
R 1053	J24185103	CHIP RES. RMC1/16 103JATP	10K
R 1054	J24185223	CHIP RES. RMC1/16 223JATP	22K
R 1055	J24185103	CHIP RES. RMC1/16 103JATP	10K
R 1056	J24185223	CHIP RES. RMC1/16 223JATP	22K
R 1057	J24185102	CHIP RES. RMC1/16 102JATP	1K
R 1058	J24185684	CHIP RES. RMC1/16 684JATP	680K
R 1059	J24185222	CHIP RES. RMC1/16 222JATP	2.2K
R 1060	J24185105	CHIP RES. RMC1/16 105JATP	1M
R 1061	J24185223	CHIP RES. RMC1/16 223JATP	22K
R 1062	J24185223	CHIP RES. RMC1/16 223JATP	22K
R 1063	J24185000	CHIP RES. RMC1/16 000JATP	0
R 1066	J24185000	CHIP RES. RMC1/16 000JATP	0
R 1067	J24185000	CHIP RES. RMC1/16 000JATP	0
R 1068	J24185000	CHIP RES. RMC1/16 000JATP	0
R 1069	J24185000	CHIP RES. RMC1/16 000JATP	0
R 1070	J24185000	CHIP RES. RMC1/16 000JATP	0

CONTROL UNIT PARTS LIST

ADD	CODE No.	DESCRIPTION	
R 1071	J24185000	CHIP RES. RMC1/16 000JATP	0
R 1072	J24185000	CHIP RES. RMC1/16 000JATP	0
R 1074	J24205000	CHIP RES. RMC1/10T 000J	0
R 1075	J24185103	CHIP RES. RMC1/16 103JATP	10K
R 1076	J24205473	CHIP RES. RMC1/10 473J	47K
R 1077	J24205104	CHIP RES. RMC1/10T 104J	100K
R 1078	J24205104	CHIP RES. RMC1/10T 104J	100K
S 1001	N5090037	TACT SWITCH JPM0300-0101R	
S 1004	Q9000442	ROTARY CODE SWITCH EC09P20-04	
X 1001	H0102904	XTAL UM-1 1.0MHZ	1.00MHZ

RF UNIT PARTS LAYOUT

RF UNIT (No.2XXX)

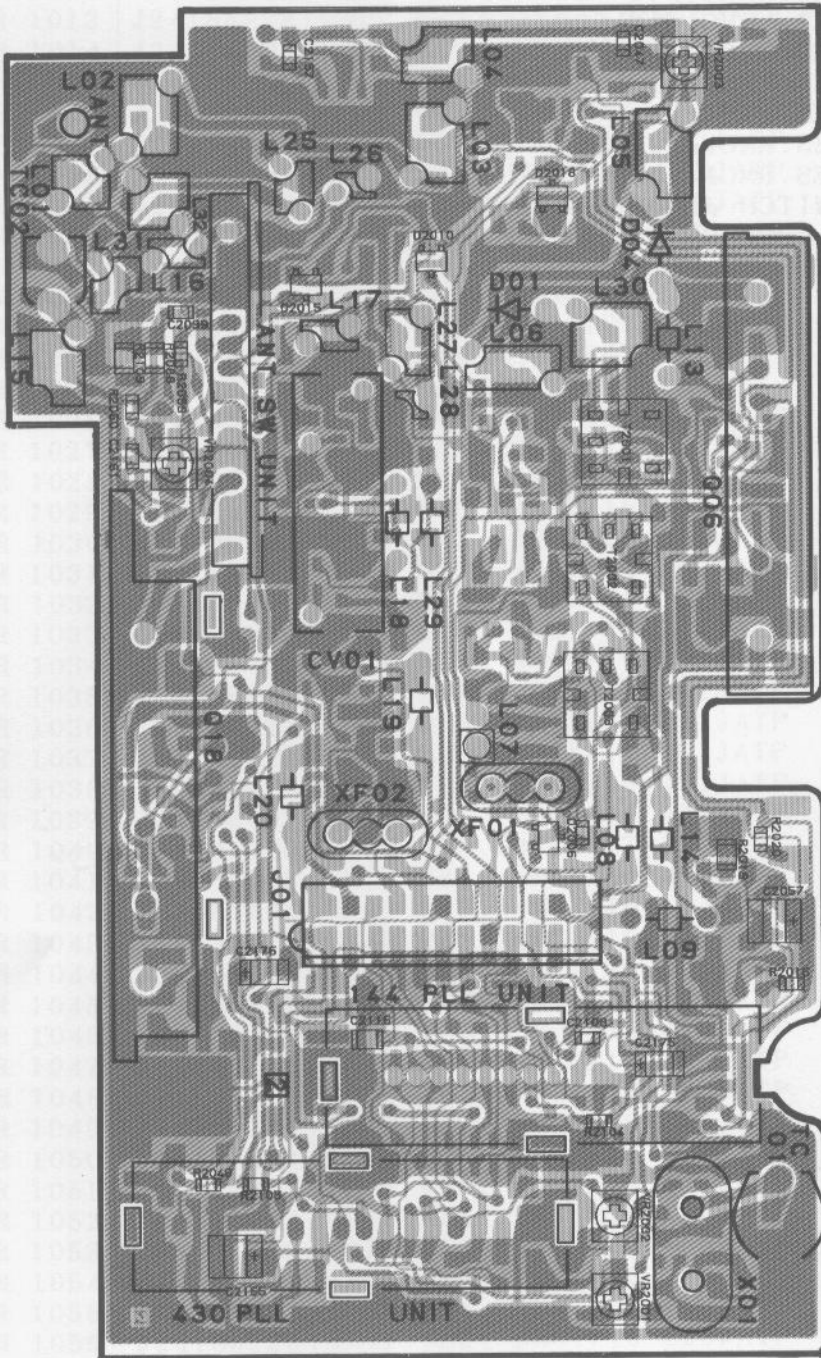

obverse view of "component" side

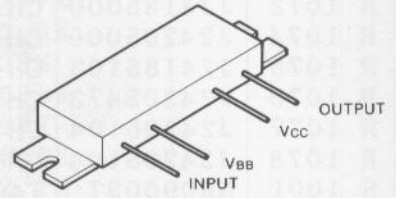

M57796MA (Q2006)

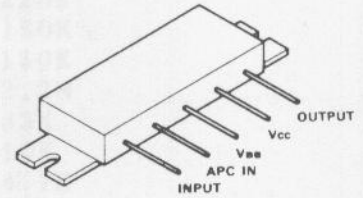

M57797MA (Q2018)

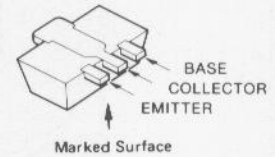

2SB799(ML)
(Q2008,2012,2020,2024)
2SC2954(QK) (Q2005,2017)

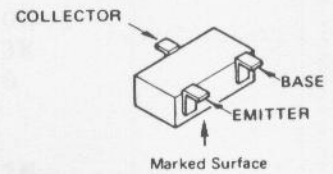

2SC2714Y(QY) (Q2004)
2SC3356(R24)
(Q2013,2031,2033)
2SC3583(R32) (Q2014,2032)
2SC4116GR(LG)
(Q2011,2023,2027,2028)
2SC4215Y(QY) (Q2003,2015)
2SC4245(HB) (Q2002)
RN1303(XC)
(Q2007,2025,2026,2029)
2030

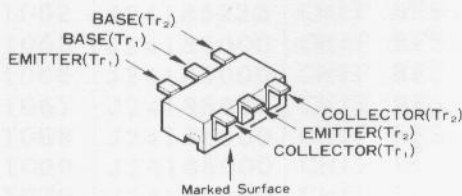

IMX5(X5) (Q2001)

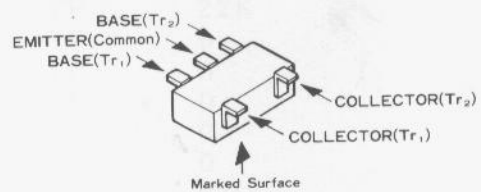

FMS1(S1) (Q2010,2022), FMW1(W1) (Q2009,2021)

RF UNIT PARTS LAYOUT

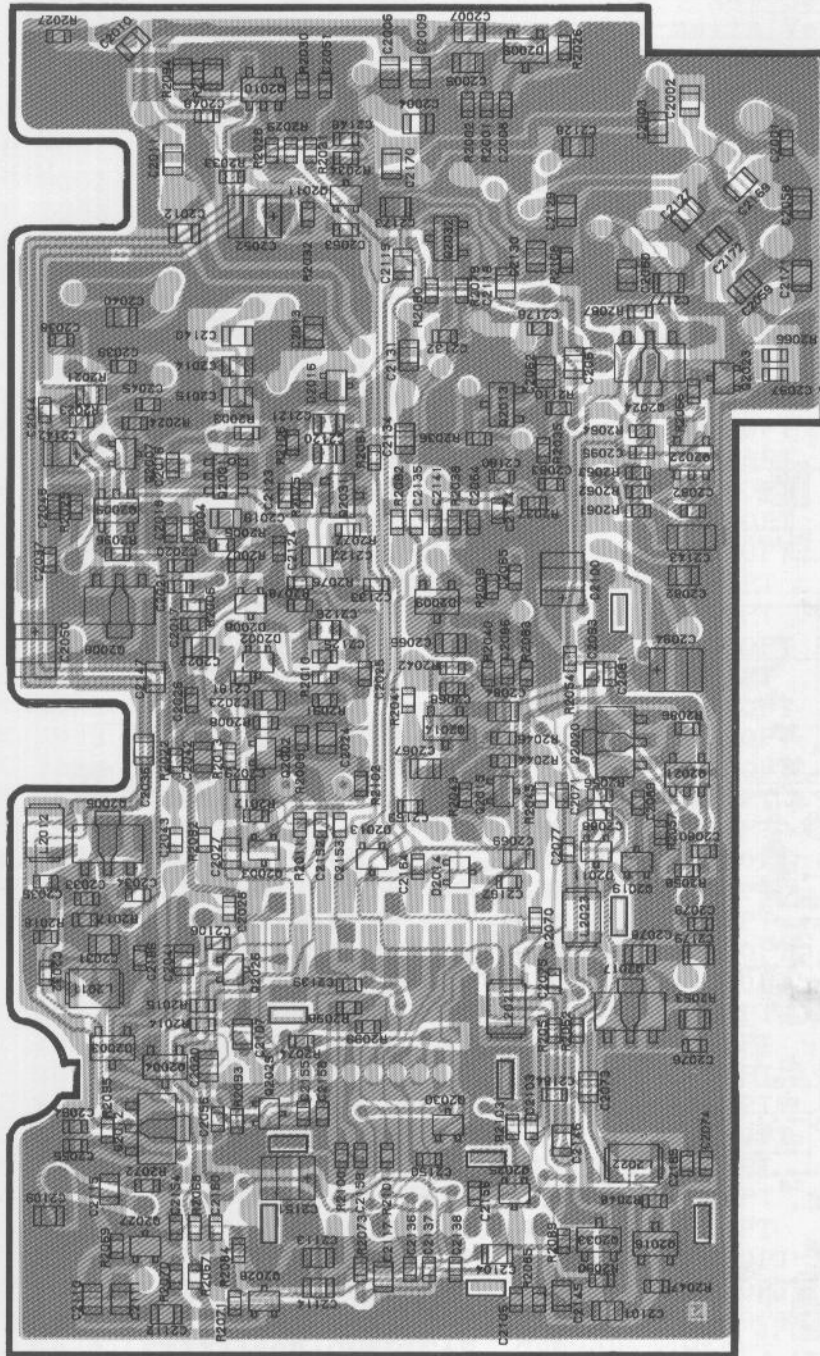

obverse view of "chip-only" side

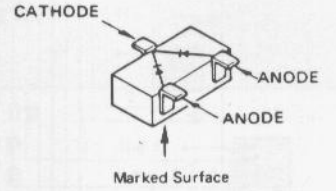

- 1SS184(B3) (Q2003)
- 1SS301(B3)
- (D2002, 2006, 2008)
- (2011, 2013, 2014)
- 2017, 2018
- 1SS321(F9) (Q2005)
- DAN235K(M) (Q2009)

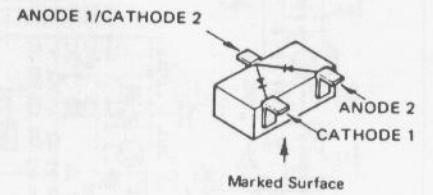

- 1SS302(C3) (Q2015)

RF UNIT CIRCUIT DIAGRAM

RF UNIT F3038101B

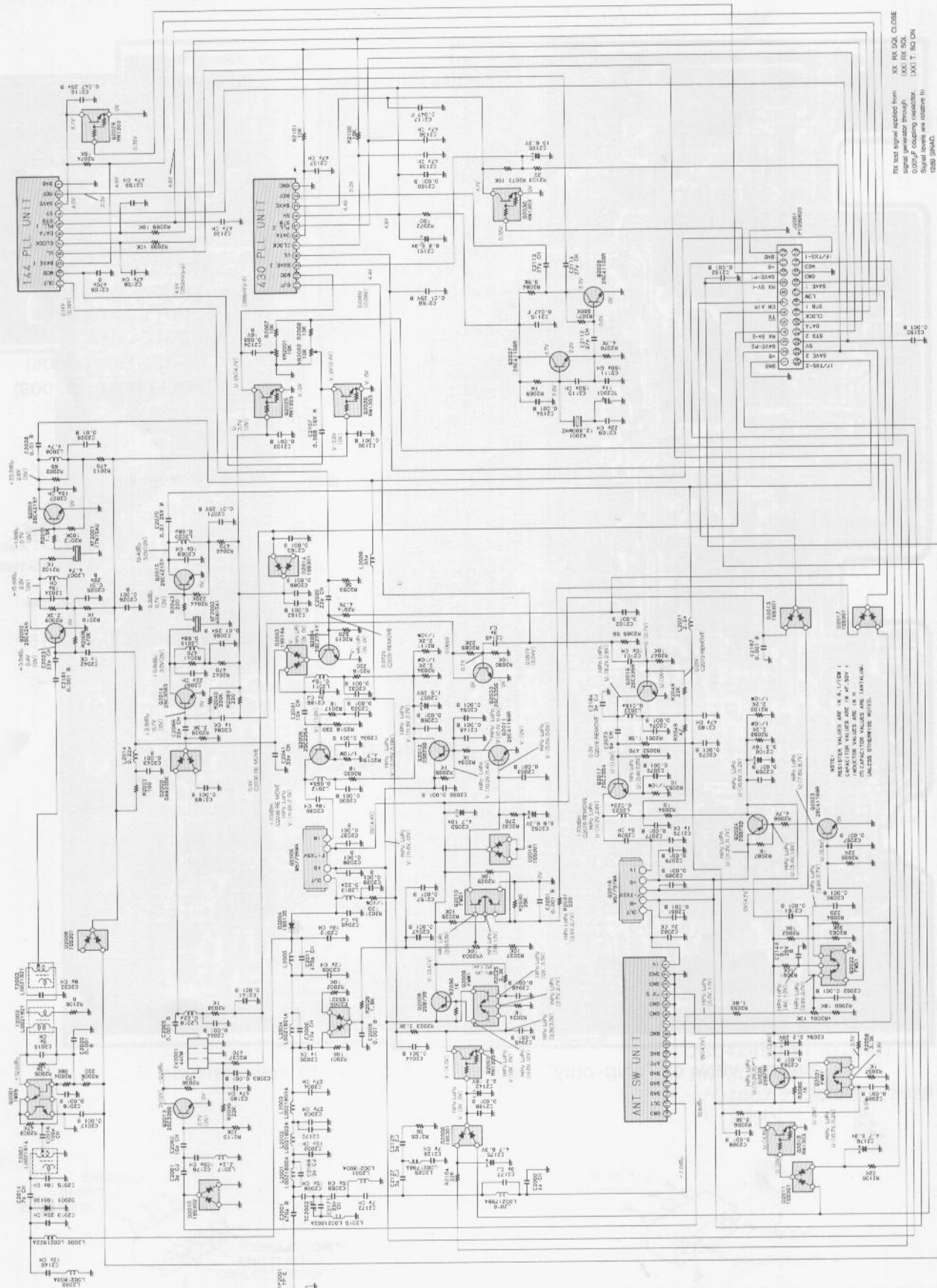

RF test signal applied from signal generator through 0.001µF coupling capacitor. Signal levels are relative to 100dBm.

XX: RX, GND, CLOSE
 XXX: RX, SWL
 LXX: T, BO ON

NOTE: VALUES ARE IN Ω, KΩ, MΩ, U.S. UNITS UNLESS OTHERWISE NOTED.

SEMICONDUCTORS
 SUB-UNITS

RF UNIT PARTS LIST

ADD	CODE No.	DESCRIPTION		
CP1102002 PCB with Components W/Sub-units Ver. A1 (VHF PLL, UHF PLL, ANT SW, Units)				
CP1102003 PCB with Components W/Sub-units Ver. A2 (VHF PLL, UHF PLL, ANT SW, Units)				
F3038101B Printed Circuit Board				
C 2001	K22174805	CHIP CAP. GRM39B471M50PT	470p	
C 2002	K22170215	CHIP CAP. GRM40CH150J50PT	15p	
C 2003	K22170221	CHIP CAP. GRM40CH270J50PT	27p	
C 2004	K22170221	CHIP CAP. GRM40CH270J50PT	27p	
C 2005	K22170202	CHIP CAP. GRM40CK010C50PT	1p	
C 2006	K22170211	CHIP CAP. GRM40CH100D50PT	10p	
C 2008	K22174809	CHIP CAP. GRM39B102M50PT	0.001	
C 2009	K22170213	CHIP CAP. GRM40CH120J50PT	12p	
C 2011	K22170251	CHIP CAP. GRM40CH471J50PT	470p	
C 2012	K22170217	CHIP CAP. GRM40CH180J50PT	18p	
C 2013	K22170219	CHIP CAP. GRM40CH220J50PT	22p	
C 2014	K22170208	CHIP CAP. GRM40CH070D50PT	7p	
C 2015	K22170217	CHIP CAP. GRM40CH180J50PT	18p	
C 2016	K22174235	CHIP CAP. GRM39CH101J50PT	100p	
C 2017	K22174809	CHIP CAP. GRM39B102M50PT	0.001	
C 2018	K22174809	CHIP CAP. GRM39B102M50PT	0.001	
C 2019	K22170210	CHIP CAP. GRM40CH090D50PT	9p	
C 2020	K22174809	CHIP CAP. GRM39B102M50PT	0.001	
C 2022	K22170209	CHIP CAP. GRM40CH080D50PT	8p	
C 2023	K22170219	CHIP CAP. GRM40CH220J50PT	22p	
C 2024	K22170215	CHIP CAP. GRM40CH150J50PT	15p	
C 2025	K22144802	CHIP CAP. GRM39B103M25PT	0.01	25V
C 2026	K22174809	CHIP CAP. GRM39B102M50PT	0.001	
C 2027	K22170215	CHIP CAP. GRM40CH150J50PT	15p	
C 2028	K22170817	CHIP CAP. GRM40B103M50PT	0.01	
C 2029	K22170817	CHIP CAP. GRM40B103M50PT	0.01	
C 2030	K22170219	CHIP CAP. GRM40CH220J50PT	22p	
C 2031	K22170211	CHIP CAP. GRM40CH100D50PT	10p	
C 2032	K22174809	CHIP CAP. GRM39B102M50PT	0.001	
C 2033	K22174809	CHIP CAP. GRM39B102M50PT	0.001	
C 2034	K22174809	CHIP CAP. GRM39B102M50PT	0.001	
C 2035	K22174809	CHIP CAP. GRM39B102M50PT	0.001	
C 2036	K22170217	CHIP CAP. GRM40CH180J50PT	18p	
C 2037	K22174809	CHIP CAP. GRM39B102M50PT	0.001	
C 2038	K22174809	CHIP CAP. GRM39B102M50PT	0.001	
C 2039	K22174809	CHIP CAP. GRM39B102M50PT	0.001	
C 2040	K22174204	CHIP CAP. GRM39CJ030C50PT	3p	
C 2041	K22170223	CHIP CAP. GRM40CH330J50PT	33p	
C 2042	K22170202	CHIP CAP. GRM40CK010C50PT	1p	
C 2043	K22174809	CHIP CAP. GRM39B102M50PT	0.001	
C 2044	K22174809	CHIP CAP. GRM39B102M50PT	0.001	
C 2045	K22174809	CHIP CAP. GRM39B102M50PT	0.001	
C 2046	K22174809	CHIP CAP. GRM39B102M50PT	0.001	
C 2047	K22174809	CHIP CAP. GRM39B102M50PT	0.001	
C 2050	K78100010	CHIP TA. CAP. TESVB21A475M8R	4.7	10V
C 2051	K22174809	CHIP CAP. GRM39B102M50PT	0.001	
C 2052	K78080010	CHIP TA. CAP. TESVB20J685M8R	6.8	6.3V
C 2053	K22174809	CHIP CAP. GRM39B102M50PT	0.001	
C 2054	K22174809	CHIP CAP. GRM39B102M50PT	0.001	
C 2055	K22174809	CHIP CAP. GRM39B102M50PT	0.001	

RF UNIT PARTS LIST

ADD	CODE No.	DESCRIPTION		
C 2056	K22174809	CHIP CAP. GRM39B102M50PT	0.001	
C 2057	K78140010	CHIP TA. CAP. TESVB21E155M8R	1.5	25V
C 2058	K22170215	CHIP CAP. GRM40CH150J50PT	15p	
C 2059	K22170206	CHIP CAP. GRM40CH050C50PT	5p	
C 2060	K22170205	CHIP CAP. GRM40CH040C50PT	4p	
C 2061	K22170204	CHIP CAP. GRM40CJ030C50PT	3p	
C 2062	K22170211	CHIP CAP. GRM40CH100D50PT	10p	
C 2063	K22174809	CHIP CAP. GRM39B102M50PT	0.001	
C 2064	K22174809	CHIP CAP. GRM39B102M50PT	0.001	
C 2065	K22174809	CHIP CAP. GRM39B102M50PT	0.001	
C 2066	K22170223	CHIP CAP. GRM40CH330J50PT	33p	
C 2067	K22170219	CHIP CAP. GRM40CH220J50PT	22p	
C 2068	K22144802	CHIP CAP. GRM39B103M25PT	0.01	25V
C 2069	K22170211	CHIP CAP. GRM40CH100D50PT	10p	
C 2070	K22144802	CHIP CAP. GRM39B103M25PT	0.01	25V
C 2071	K22144802	CHIP CAP. GRM39B103M25PT	0.01	25V
C 2073	K22174207	CHIP CAP. GRM39CH060D50PT	6p	
C 2074	K22174809	CHIP CAP. GRM39B102M50PT	0.001	
C 2075	K22174809	CHIP CAP. GRM39B102M50PT	0.001	
C 2076	K22174809	CHIP CAP. GRM39B102M50PT	0.001	
C 2077	K22174809	CHIP CAP. GRM39B102M50PT	0.001	
C 2078	K22170206	CHIP CAP. GRM40CH050C50PT	5p	
C 2079	K22174809	CHIP CAP. GRM39B102M50PT	0.001	
C 2080	K22174809	CHIP CAP. GRM39B102M50PT	0.001	
C 2081	K22174809	CHIP CAP. GRM39B102M50PT	0.001	
C 2082	K22170203	CHIP CAP. GRM40CK020C50PT	2p	
C 2084	K22170202	CHIP CAP. GRM40CK010C50PT	1p	
C 2086	K22174809	CHIP CAP. GRM39B102M50PT	0.001	
C 2088	K22174809	CHIP CAP. GRM39B102M50PT	0.001	
C 2089	K22174809	CHIP CAP. GRM39B102M50PT	0.001	
C 2092	K22174809	CHIP CAP. GRM39B102M50PT	0.001	
C 2093	K22174809	CHIP CAP. GRM39B102M50PT	0.001	
C 2094	K78130010	CHIP TA. CAP. TESVB21D225M8R	2.2	20V
C 2095	K22174809	CHIP CAP. GRM39B102M50PT	0.001	
C 2097	K22174809	CHIP CAP. GRM39B102M50PT	0.001	
C 2099	K22174809	CHIP CAP. GRM39B102M50PT	0.001	
C 2100	K78120010	CHIP TA. CAP. TESVB21C335M8R	3.3	16V
C 2101	K22170211	CHIP CAP. GRM40CH100D50PT	10p	
C 2102	K22174809	CHIP CAP. GRM39B102M50PT	0.001	
C 2103	K22174809	CHIP CAP. GRM39B102M50PT	0.001	
C 2104	K22120805	CHIP CAP. GRM40R683M16PT	0.068	16V
C 2106	K22174809	CHIP CAP. GRM39B102M50PT	0.001	
C 2107	K22120805	CHIP CAP. GRM40R683M16PT	0.068	16V
C 2108	K22174805	CHIP CAP. GRM39B471M50PT	470p	
C 2109	K22170219	CHIP CAP. GRM40CH220J50PT	22p	
C 2110	K22170239	CHIP CAP. GRM40CH151J50PT	150p	
C 2111	K22170239	CHIP CAP. GRM40CH151J50PT	150p	
C 2112	K22170221	CHIP CAP. GRM40CH270J50PT	27p	
C 2113	K22170221	CHIP CAP. GRM40CH270J50PT	27p	
C 2114	K22170221	CHIP CAP. GRM40CH270J50PT	27p	
C 2115	K22171008	CHIP CAP. GRM40F473Z50PT	0.047	

RF UNIT PARTS LIST

ADD	CODE No.	DESCRIPTION		
C 2116	K22141808	CHIP CAP. GRM42-6B473M25PT	0.047	25V
C 2117	K22171008	CHIP CAP. GRM40F473Z50PT	0.047	
C 2127	K22170204	CHIP CAP. GRM40CJ030C50PT	3p	
C 2128	K22170208	CHIP CAP. GRM40CH070D50PT	7p	
C 2129	K22170204	CHIP CAP. GRM40CJ030C50PT	3p	
C 2136	K22174227	CHIP CAP. GRM39CH470J50PT	47p	
C 2137	K22174227	CHIP CAP. GRM39CH470J50PT	47p	
C 2138	K22174227	CHIP CAP. GRM39CH470J50PT	47p	
C 2139	K22174227	CHIP CAP. GRM39CH470J50PT	47p	
C 2140	K22170213	CHIP CAP. GRM40CH120J50PT	12p	
C 2141	K22174809	CHIP CAP. GRM39B102M50PT	0.001	
C 2142	K78120002	CHIP TA CAP. F951C225MSAAF1Q2	2.2 *	16V
C 2143	K22141809	CHIP CAP. GRM42-6B104M25PT	0.1	25V
C 2145	K22170204	CHIP CAP. GRM40CJ030C50PT	3p	
C 2148	K22174809	CHIP CAP. GRM39B102M50PT	0.001	
C 2150	K22174809	CHIP CAP. GRM39B102M50PT	0.001	
C 2151	K78080010	CHIP TA. CAP. TESVB20J685M8R	6.8	6.3V
C 2152	K22174809	CHIP CAP. GRM39B102M50PT	0.001	
C 2154	K22174809	CHIP CAP. GRM39B102M50PT	0.001	
C 2156	K22144802	CHIP CAP. GRM39B103M25PT	0.01	25V
C 2157	K22174809	CHIP CAP. GRM39B102M50PT	0.001	
C 2158	K22174227	CHIP CAP. GRM39CH470J50PT	47p	
C 2159	K22174227	CHIP CAP. GRM39CH470J50PT	47p	
C 2160	K22174809	CHIP CAP. GRM39B102M50PT	0.001	
C 2161	K22174809	CHIP CAP. GRM39B102M50PT	0.001	
C 2162	K22174809	CHIP CAP. GRM39B102M50PT	0.001	
C 2163	K22174809	CHIP CAP. GRM39B102M50PT	0.001	
C 2165	K78080019	CHIP TA. CAP. TEMSVB20J106M-8R	10	6.3V
C 2169	K22170204	CHIP CAP. GRM40CJ030C50PT	3p	
C 2170	K10179024	CERAMIC CAP. CK45B1H103KYS		
C 2171	K22170223	CHIP CAP. GRM40CH330J50PT	33p	
C 2172	K22170208	CHIP CAP. GRM40CH070D50PT	7p	
C 2175	K78080017	CHIP TA. CAP. TEMSVA0J475M-8R	4.7	6.3V
C 2176	K78080017	CHIP TA. CAP. TEMSVA0J475M-8R	4.7	6.3V
C 2177	K22170204	CHIP CAP. GRM40CJ030C50PT	3p	
C 2178	K22174235	CHIP CAP. GRM39CH101J50PT	100p	
C 2179	K22170202	CHIP CAP. GRM40CK010C50PT	1p	
C 2180	K22174227	CHIP CAP. GRM39CH470J50PT	47p	
C 2181	K22174809	CHIP CAP. GRM39B102M50PT	0.001	
C 2184	K22174204	CHIP CAP. GRM39CJ030C50PT	3p	
C 2185	K22174227	CHIP CAP. GRM39CH470J50PT	47p	
C 2186	K22174204	CHIP CAP. GRM39CJ030C50PT	3p	
C 2187	K22174809	CHIP CAP. GRM39B102M50PT	0.001	
C 2188	K22174809	CHIP CAP. GRM39B102M50PT	0.001	
C 2189	K22174809	CHIP CAP. GRM39B102M50PT	0.001	
CV2001	L4020100	HELICAL RESONATOR 440M	440M	
D 2001	G2040001	DIODE 1SS135 T-91	1SS135	
D 2003	G2070009	DIODE 1SS184 TE85R	1SS184	
D 2004	G2040001	DIODE 1SS135 T-91	1SS135	
D 2005	G2070076	DIODE 1SS321 TE85R	1SS321	
D 2006	G2070086	DIODE 1SS301 TE85R	1SS301	

RF UNIT PARTS LIST

ADD	CODE No.	DESCRIPTION	
D 2008	G2070086	DIODE 1SS301 TE85R	1SS301
D 2009	G2070082	DIODE DAN235K T97	DAN235K
D 2011	G2070086	DIODE 1SS301 TE85R	1SS301
D 2013	G2070086	DIODE 1SS301 TE85R	1SS301
D 2014	G2070086	DIODE 1SS301 TE85R	1SS301
D 2015	G2070088	DIODE 1SS302 TE85R	1SS302
D 2017	G2070086	DIODE 1SS301 TE85R	1SS301
D 2018	G2070086	DIODE 1SS301 TE85R	1SS301
J 2001	P1090620	CONNECTOR 52022-2410	
L 2001	L0021800	REPLACED BY L0021767	
L 2002	L0021803	COIL L0021803	
L 2003	L0021803	COIL L0021803	
L 2004	L0021801	COIL L0021801	
L 2005	L0021928	COIL L0021928	
L 2006	L0021922	COIL L0021922	
L 2007	L1190343	M.RFC LAL02KR4R7K	4.7u
L 2008	L1190343	M.RFC LAL02KR4R7K	4.7u
L 2009	L1190301	M.RFC LAL02NA330K	33u
L 2011	L1690013	CHIP COIL LQN2AR15K	0.15u
L 2012	L1690009	CHIP COIL LQN2A68NM	0.068u
L 2013	L1190342	M.RFC LAL02KRR22M	0.22u
L 2014	L1190342	M.RFC LAL02KRR22M	0.22u
L 2015	L0021802	COIL L0021802	
L 2016	L0021798	COIL L0021798	
L 2017	L1190346	M.RFC LAL02KR2R2M	2.2u
L 2018	L1190342	M.RFC LAL02KRR22M	0.22u
L 2019	L1190347	M.RFC LAL02KRR68M	0.68u
L 2020	L1190347	M.RFC LAL02KRR68M	0.68u
L 2021	L1690017	COIL 32CS 380LB-2R2M=P	2.2u
L 2022	L1690004	CHIP COIL LQN2A18NM	0.018u
L 2023	L1690002	CHIP COIL LQN2A22NM	0.022u
L 2025	L0021798	COIL L0021798	
L 2030	L0021803	COIL L0021803	
L 2031	L0021800	REPLACED BY L0021767	
Q 2001	G3070028	TRANSISTOR IMX5 T108	IMX5
Q 2002	G3342457	TRANSISTOR 2SC4245 TE85R	2SC4245
Q 2003	G3342157Y	TRANSISTOR 2SC4215Y TE85R	2SC4215Y
Q 2004	G3327147Y	TRANSISTOR 2SC2714YTE85R	2SC2714Y
Q 2005	G3329547	TRANSISTOR 2SC2954-T2	2SC2954
Q 2006	G1090732	IC M57796MA	M57796MA
Q 2007	G3070037	TRANSISTOR RN1303 TE85R	RN1303
Q 2008	G3207997L	TRANSISTOR 2SB799-T2ML	2SB799 ML
Q 2009	G3070009	TRANSISTOR FMW1 T98	FMW1
Q 2010	G3070008	TRANSISTOR FMS1 T98	FMS1
Q 2011	G3341167G	TRANSISTOR 2SC4116GR TE85R	2SC4116GR
Q 2012	G3207997L	TRANSISTOR 2SB799-T2ML	2SB799 ML
Q 2013	G3333567	TRANSISTOR 2SC3356-T2B	2SC3356
Q 2014	G3335837	TRANSISTOR 22SC3583-T2BR32	2SC3583
Q 2015	G3342157Y	TRANSISTOR 2SC4215Y TE85R	2SC4215Y
Q 2016	G3333567	TRANSISTOR 2SC3356-T2B	2SC3356
Q 2017	G3329547	TRANSISTOR 2SC2954-T2	2SC2954

RF UNIT PARTS LIST

ADD	CODE No.	DESCRIPTION	
Q 2018	G1090733	IC M57797MA	M57797MA
Q 2019	G3070037	TRANSISTOR RN1303 TE85R	RN1303
Q 2020	G3207997L	TRANSISTOR 2SB799-T2ML	2SB799 ML
Q 2021	G3070009	TRANSISTOR FMW1 T98	FMW1
Q 2022	G3070008	TRANSISTOR FMS1 T98	FMS1
Q 2023	G3341167G	TRANSISTOR 2SC4116GR TE85R	2SC4116GR
Q 2024	G3207997L	TRANSISTOR 2SB799-T2ML	2SB799 ML
Q 2025	G3070037	TRANSISTOR RN1303 TE85R	RN1303
Q 2026	G3070037	TRANSISTOR RN1303 TE85R	RN1303
Q 2027	G3341167G	TRANSISTOR 2SC4116GR TE85R	2SC4116GR
Q 2028	G3341167G	TRANSISTOR 2SC4116GR TE85R	2SC4116GR
Q 2029	G3070037	TRANSISTOR RN1303 TE85R	RN1303
Q 2030	G3070037	TRANSISTOR RN1303 TE85R	RN1303
Q 2033	G3333567	TRANSISTOR 2SC3356-T2B	2SC3356
R 2001	J24185103	CHIP RES. RMC1/16 103JATP	10K
R 2002	J24185103	CHIP RES. RMC1/16 103JATP	10K
R 2003	J24185473	CHIP RES. RMC1/16 473JATP	47K
R 2004	J24185563	CHIP RES. RMC1/16 563JATP	56K
R 2005	J24185122	CHIP RES. RMC1/16 122JATP	1.2K
R 2006	J24185221	CHIP RES. RMC1/16 221JATP	220
R 2008	J24185474	CHIP RES. RMC1/16 474JATP	470K
R 2009	J24185222	CHIP RES. RMC1/16 222JATP	2.2K
R 2010	J24185102	CHIP RES. RMC1/16 102JATP	1K
R 2011	J24185152	CHIP RES. RMC1/16 152JATP	1.5K
R 2012	J24185104	CHIP RES. RMC1/16 104JATP	100K
R 2013	J24185471	CHIP RES. RMC1/16 471JATP	470
R 2014	J24185472	CHIP RES. RMC1/16 472JATP	4.7K
R 2015	J24185821	CHIP RES. RMC1/16 821JATP	820
R 2016	J24185221	CHIP RES. RMC1/16 221JATP	220
R 2017	J24185102	CHIP RES. RMC1/16 102JATP	1K
R 2018	J24185331	CHIP RES. RMC1/16 331JATP	330
R 2019	J24205479	CHIP RES. RMC1/10T 4R7J	4.7
R 2020	J24185180	CHIP RES. RMC1/16 180JATP	18
R 2021	J24205121	CHIP RES. RMC1/10T 121J	120
R 2022	J24185101	CHIP RES. RMC1/16 101JATP	100
R 2023	J24185332	CHIP RES. RMC1/16 332JATP	3.3K
R 2024	J24185102	CHIP RES. RMC1/16 102JATP	1K
R 2025	J24185332	CHIP RES. RMC1/16 332JATP	3.3K
R 2026	J24185182	CHIP RES. RMC1/16 182JATP	1.8K
R 2027	J24185103	CHIP RES. RMC1/16 103JATP	10K
R 2028	J24185103	CHIP RES. RMC1/16 103JATP	10K
R 2029	J24185103	CHIP RES. RMC1/16 103JATP	10K
R 2030	J24185393	CHIP RES. RMC1/16 393JATP	39K
R 2031	J24185221	CHIP RES. RMC1/16 221JATP	220
R 2032	J24185271	CHIP RES. RMC1/16 271JATP	270
R 2034	J24185102	CHIP RES. RMC1/16 102JATP	1K
R 2035	J24185223	CHIP RES. RMC1/16 223JATP	22K
R 2036	J24185471	CHIP RES. RMC1/16 471JATP	470
R 2037	J24185471	CHIP RES. RMC1/16 471JATP	470
R 2038	J24185102	CHIP RES. RMC1/16 102JATP	1K
R 2039	J24185332	CHIP RES. RMC1/16 332JATP	3.3K

RF UNIT PARTS LIST

ADD	CODE No.	DESCRIPTION	
R 2040	J24185334	CHIP RES. RMC1/16 334JATP	330K
R 2041	J24185471	CHIP RES. RMC1/16 471JATP	470
R 2042	J24185471	CHIP RES. RMC1/16 471JATP	470
R 2043	J24185221	CHIP RES. RMC1/16 221JATP	220
R 2044	J24185224	CHIP RES. RMC1/16 224JATP	220K
R 2046	J24185471	CHIP RES. RMC1/16 471JATP	470
R 2047	J24185103	CHIP RES. RMC1/16 103JATP	10K
R 2048	J24185223	CHIP RES. RMC1/16 223JATP	22K
R 2049	J24185470	CHIP RES. RMC1/16 470JATP	47
R 2051	J24185152	CHIP RES. RMC1/16 152JATP	1.5K
R 2052	J24185471	CHIP RES. RMC1/16 471JATP	470
R 2053	J24205100	CHIP RES. RMC1/10T 100J	10
R 2054	J24185100	CHIP RES. RMC1/16 100JATP	10
R 2056	J24185332	CHIP RES. RMC1/16 332JATP	3.3K
R 2057	J24185102	CHIP RES. RMC1/16 102JATP	1K
R 2058	J24185332	CHIP RES. RMC1/16 332JATP	3.3K
R 2059	J24185182	CHIP RES. RMC1/16 182JATP	1.8K
R 2060	J24185183	CHIP RES. RMC1/16 183JATP	18K
R 2061	J24185103	CHIP RES. RMC1/16 103JATP	10K
R 2062	J24185103	CHIP RES. RMC1/16 103JATP	10K
R 2063	J24185393	CHIP RES. RMC1/16 393JATP	39K
R 2064	J24185221	CHIP RES. RMC1/16 221JATP	220
R 2065	J24185223	CHIP RES. RMC1/16 223JATP	22K
R 2066	J24185472	CHIP RES. RMC1/16 472JATP	4.7K
R 2067	J24185103	CHIP RES. RMC1/16 103JATP	10K
R 2068	J24185103	CHIP RES. RMC1/16 103JATP	10K
R 2069	J24185105	CHIP RES. RMC1/16 105JATP	1M
R 2070	J24185472	CHIP RES. RMC1/16 472JATP	4.7K
R 2071	J24185684	CHIP RES. RMC1/16 684JATP	680K
R 2072	J24185101	CHIP RES. RMC1/16 101JATP	100
R 2073	J24185153	CHIP RES. RMC1/16 153JATP	15K
R 2074	J24185153	CHIP RES. RMC1/16 153JATP	15K
R 2083	J24185221	CHIP RES. RMC1/16 221JATP	220
R 2084	J24185392	CHIP RES. RMC1/16 392JATP	3.9K
R 2085	J24185560	CHIP RES. RMC1/16 560JATP	56
R 2086	J24185102	CHIP RES. RMC1/16 102JATP	1K
R 2087	J24185102	CHIP RES. RMC1/16 102JATP	1K
R 2088	J24205222	CHIP RES. RMC1/10 222J	2.2K
R 2089	J24185223	CHIP RES. RMC1/16 223JATP	22K
R 2090	J24185103	CHIP RES. RMC1/16 103JATP	10K
R 2092	J24185680	CHIP RES. RMC1/16 680JATP	68
R 2093	J24185560	CHIP RES. RMC1/16 560JATP	56
R 2094	J24205222	CHIP RES. RMC1/10 222J	2.2K
R 2095	J24185102	CHIP RES. RMC1/16 102JATP	1K
R 2096	J24185102	CHIP RES. RMC1/16 102JATP	1K
R 2098	J24185103	CHIP RES. RMC1/16 103JATP	10K
R 2099	J24185103	CHIP RES. RMC1/16 103JATP	10K
R 2100	J24185103	CHIP RES. RMC1/16 103JATP	10K
R 2101	J24185103	CHIP RES. RMC1/16 103JATP	10K
R 2102	J24185102	CHIP RES. RMC1/16 102JATP	1K
R 2103	J24185220	CHIP RES. RMC1/16 220JATP	22

RF UNIT PARTS LIST

ADD	CODE No.	DESCRIPTION	
R 2104	J24185223	CHIP RES. RMC1/16 223JATP	22K
R 2105	J24185223	CHIP RES. RMC1/16 223JATP	22K
R 2106	J24185000	CHIP RES. RMC1/16 000JATP	0
R 2108	J24185560	CHIP RES. RMC1/16 560JATP	56
R 2109	J24205222	CHIP RES. RMC1/10 222J	2.2K
R 2110	J24185103	CHIP RES. RMC1/16 103JATP	10K
R 2111	J24205222	CHIP RES. RMC1/10 222J	2.2K
T 2001	L0021914	CHIP TRANS CS-5 2276-202	
T 2002	L0021921	COIL L0021921	
T 2003	L0021921	COIL L0021921	
TC2001	K91000074	VARIABLE CAP. TZ03T110E	11p
TC2002	K91000182	TRIMMER CAP. TSW-3P-180	
TP2001	Q5000016	TERMINAL TP-E/MS-60124	TP-E
VR2001	J51778103	POT. RH03AYA14X 10K	10K
VR2002	J51778103	POT. RH03AYA14X 10K	10K
VR2003	J51778103	POT. RH03AYA14X 10K	10K
VR2004	J51778103	POT. RH03AYA14X 10K	10K
X 2001	H0102914	XTAL HC-49/T 12.800MHZ	12.800MHZ
XF2001	H1102143	XTAL FILTER 17N15AU	17N15AU
XF2002	H1102148	XTAL FILTER 45N15A1	45N15A1

VHF PLL UNIT PARTS LAYOUT/CIRCUIT DIAGRAM

VHF PLL UNIT (No.3XX)

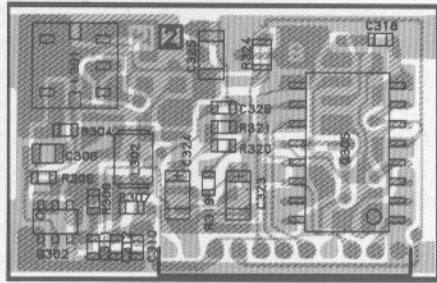

① ← → ②

obverse view of "mixed-component" side

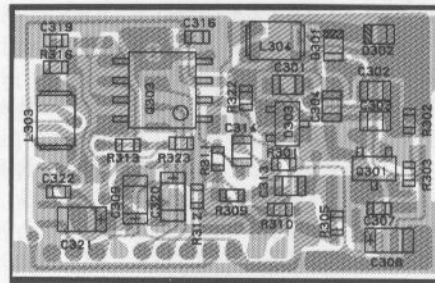

① → ← ②

obverse view of "chip-only" side

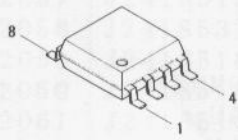

μPB569G (Q303)

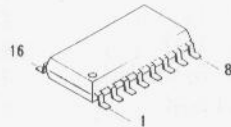

MB87076PF (Q305)

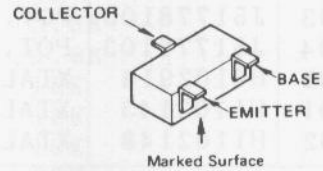

2SC3356(R24) (Q301)

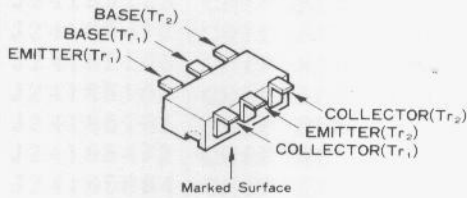

IMX5(X5) (Q302)

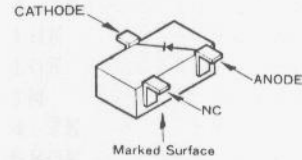

1SS153(A9) (D304)

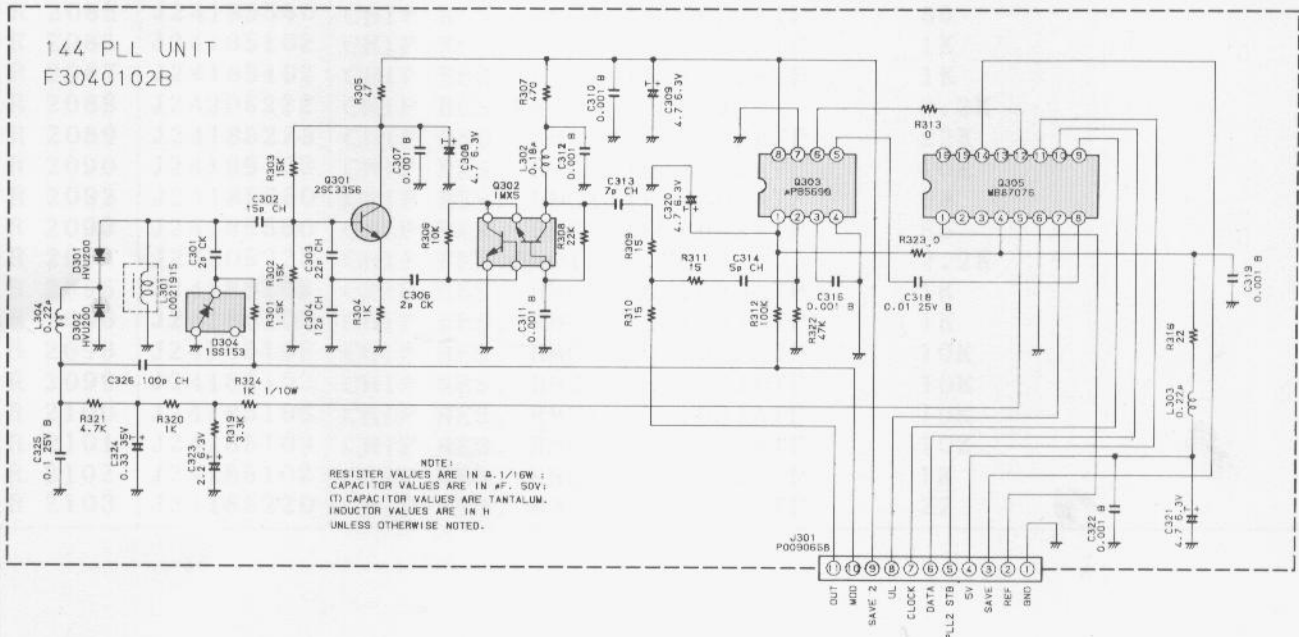

VHF PLL UNIT PARTS LIST

ADD	CODE No.	DESCRIPTION		
CP1106001 PCB with Components				
F3040102A Printed Circuit Board				
C 0301	K22170203	CHIP CAP. GRM40CK020C50PT	2p	
C 0302	K22170215	CHIP CAP. GRM40CH150J50PT	15p	
C 0303	K22170219	CHIP CAP. GRM40CH220J50PT	22p	
C 0304	K22170213	CHIP CAP. GRM40CH120J50PT	12p	
C 0306	K22170203	CHIP CAP. GRM40CK020C50PT	2p	
C 0307	K22174809	CHIP CAP. GRM39B102M50PT	0.001	
C 0308	K78080017	CHIP TA. CAP. TEMSVA0J475M-8R	4.7	6.3V
C 0309	K78080017	CHIP TA. CAP. TEMSVA0J475M-8R	4.7	6.3V
C 0310	K22174809	CHIP CAP. GRM39B102M50PT	0.001	
C 0311	K22174809	CHIP CAP. GRM39B102M50PT	0.001	
C 0312	K22174809	CHIP CAP. GRM39B102M50PT	0.001	
C 0313	K22170208	CHIP CAP. GRM40CH070D50PT	7p	
C 0314	K22170206	CHIP CAP. GRM40CH050C50PT	5p	
C 0316	K22174809	CHIP CAP. GRM39B102M50PT	0.001	
C 0318	K22144802	CHIP CAP. GRM39B103M25PT	0.01	25V
C 0319	K22170805	CHIP CAP. GRM40B102M50PT	0.001	
C 0320	K78080017	CHIP TA. CAP. TEMSVA0J475M-8R	4.7	6.3V
C 0321	K78080017	CHIP TA. CAP. TEMSVA0J475M-8R	4.7	6.3V
C 0322	K22174809	CHIP CAP. GRM39B102M50PT	0.001	
C 0323	K78080009	CHIP TA. CAP. TESVA0J225M1-8R	2.2	6.3V
C 0324	K78160028	CHIP TA. CAP. TESVA1V334M1-8R	0.33	35V
C 0325	K22141809	CHIP CAP. GRM42-6B104M25PT	0.1	25V
C 0326	K22174235	CHIP CAP. GRM39CH101J50PT	100p	
D 0301	G2070090	DIODE HVU200-5TRP	HVU200	
D 0302	G2070090	DIODE HVU200-5TRP	HVU200	
D 0304	G2070032	DIODE 1SS153-T2B	1SS153	
J 0301	P0090658	CONNECTOR 9210B-1-11Z009-T		
L 0301	L0021915	CHIP TRANS CS-5 2276-215		
L 0302	L1690014	CHIP COIL LQN2AR18K	0.18u	
L 0303	L1690003	CHIP COIL LQN2AR22K	0.22u	
L 0304	L1690003	CHIP COIL LQN2AR22K	0.22u	
Q 0301	G3333567	TRANSISTOR 2SC3356-T2B	2SC3356	
Q 0302	G3070028	TRNSISTOR IMX5 T108	IMX5	
Q 0303	G1090870	IC UPB569G	uPB569G	
Q 0305	G1090918	IC MB87076PF-G-BND	MB87076	
R 0301	J24185152	CHIP RES. RMC1/16 152JATP	1.5K	
R 0302	J24185153	CHIP RES. RMC1/16 153JATP	15K	
R 0303	J24185153	CHIP RES. RMC1/16 153JATP	15K	
R 0304	J24185102	CHIP RES. RMC1/16 102JATP	1K	
R 0305	J24185470	CHIP RES. RMC1/16 470JATP	47	
R 0306	J24185103	CHIP RES. RMC1/16 103JATP	10K	
R 0307	J24185471	CHIP RES. RMC1/16 471JATP	470	
R 0308	J24185223	CHIP RES. RMC1/16 223JATP	22K	
R 0309	J24185150	CHIP RES. RMC1/16 150JATP	15	
R 0310	J24185150	CHIP RES. RMC1/16 150JATP	15	
R 0311	J24185150	CHIP RES. RMC1/16 150JATP	15	
R 0312	J24185104	CHIP RES. RMC1/16 104JATP	100K	
R 0313	J24185000	CHIP RES. RMC1/16 000JATP	0	
R 0316	J24185220	CHIP RES. RMC1/16 220JATP	22	
R 0319	J24185332	CHIP RES. RMC1/16 332JATP	3.3K	
R 0320	J24185102	CHIP RES. RMC1/16 102JATP	1K	
R 0321	J24185472	CHIP RES. RMC1/16 472JATP	4.7K	
R 0322	J24185473	CHIP RES. RMC1/16 473JATP	47K	
R 0323	J24185000	CHIP RES. RMC1/16 000JATP	0	
R 0324	J24205102	CHIP RES. RMC1/10T 102J	1K	

UHF PLL UNIT PARTS LAYOUT/CIRCUIT DIAGRAM

UHF PLL UNIT (No.4XX)

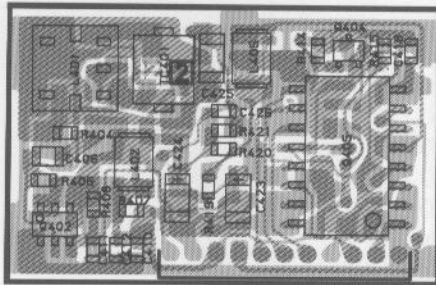

⑪ ← ①

obverse view of "mixed-component" side

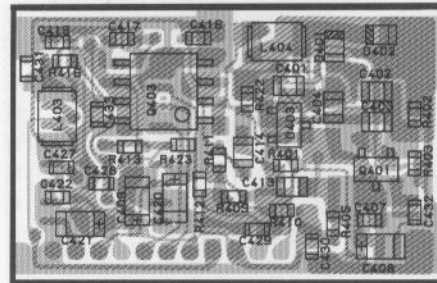

① → ⑪

obverse view of "chip-only" side

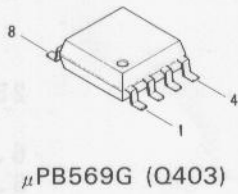

μPB569G (Q403)



MB87076PF (Q405)

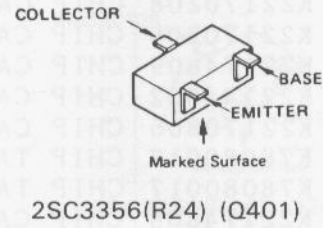

2SC3356(R24) (Q401)

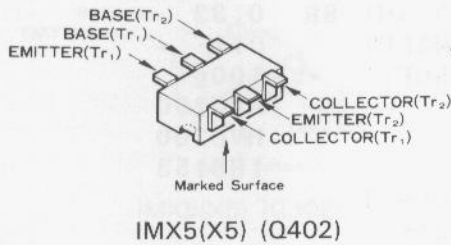

IMX5(X5) (Q402)

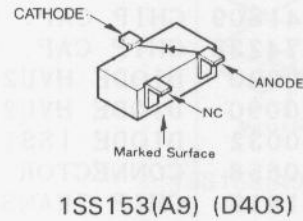

1SS153(A9) (D403)

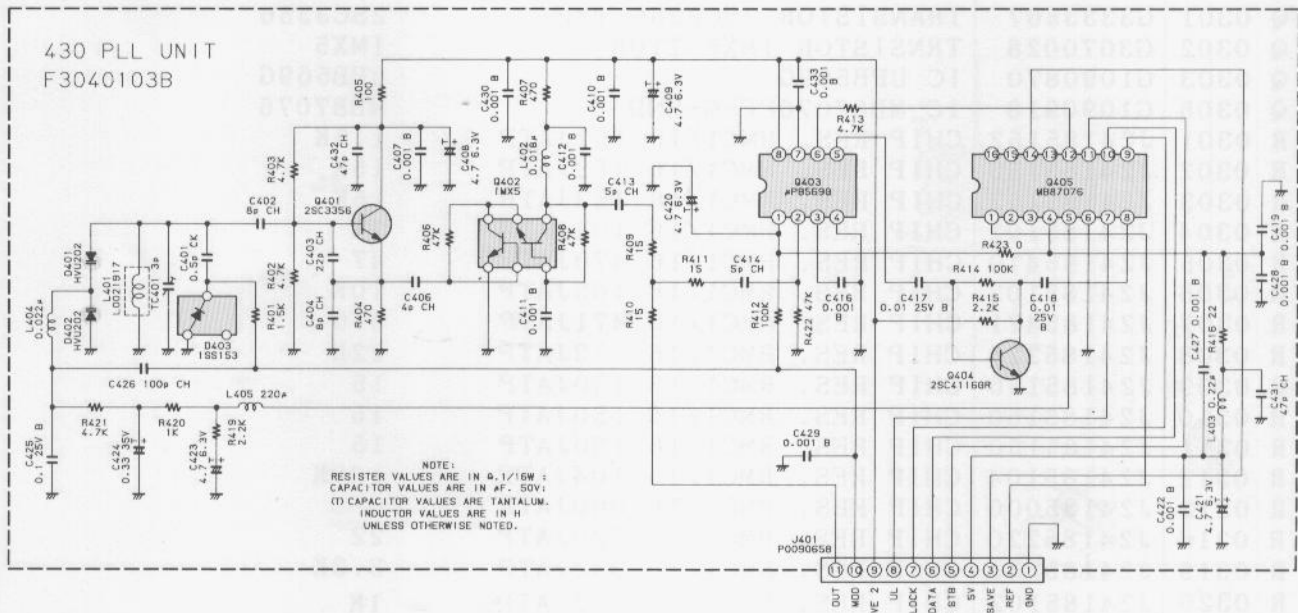

SEMICONDUCTORS

UHF PLL UNIT PARTS LIST

ADD	CODE No.	DESCRIPTION		
CP1107001 PCB with Components				
F3040103A Printed Circuit Board				
C 0401	K22170201	CHIP CAP. GRM40CK0R5C50PT	0.5p	
C 0402	K22170209	CHIP CAP. GRM40CH080D50PT	8p	
C 0403	K22170219	CHIP CAP. GRM40CH220J50PT	22p	
C 0404	K22170209	CHIP CAP. GRM40CH080D50PT	8p	
C 0406	K22170205	CHIP CAP. GRM40CH040C50PT	4p	
C 0407	K22174809	CHIP CAP. GRM39B102M50PT	0.001	
C 0408	K78080017	CHIP TA. CAP. TEMSVA0J475M-8R	4.7	6.3V
C 0409	K78080017	CHIP TA. CAP. TEMSVA0J475M-8R	4.7	6.3V
C 0410	K22174809	CHIP CAP. GRM39B102M50PT	0.001	
C 0411	K22174809	CHIP CAP. GRM39B102M50PT	0.001	
C 0412	K22174809	CHIP CAP. GRM39B102M50PT	0.001	
C 0413	K22170206	CHIP CAP. GRM40CH050C50PT	5p	
C 0414	K22170206	CHIP CAP. GRM40CH050C50PT	5p	
C 0416	K22174809	CHIP CAP. GRM39B102M50PT	0.001	
C 0417	K22144802	CHIP CAP. GRM39B103M25PT	0.01	25V
C 0418	K22144802	CHIP CAP. GRM39B103M25PT	0.01	25V
C 0419	K22170805	CHIP CAP. GRM40B102M50PT	0.001	
C 0420	K78080017	CHIP TA. CAP. TEMSVA0J475M-8R	4.7	6.3V
C 0421	K78080017	CHIP TA. CAP. TEMSVA0J475M-8R	4.7	6.3V
C 0422	K22174809	CHIP CAP. GRM39B102M50PT	0.001	
C 0423	K78080017	CHIP TA. CAP. TEMSVA0J475M-8R	4.7	6.3V
C 0424	K78160028	CHIP TA. CAP. TESVA1V334M1-8R	0.33	35V
C 0425	K22141809	CHIP CAP. GRM42-6B104M25PT	0.1	25V
C 0426	K22174235	CHIP CAP. GRM39CH101J50PT	100p	
C 0427	K22170805	CHIP CAP. GRM40B102M50PT	0.001	
C 0428	K22170805	CHIP CAP. GRM40B102M50PT	0.001	
C 0429	K22170805	CHIP CAP. GRM40B102M50PT	0.001	
C 0430	K22170805	CHIP CAP. GRM40B102M50PT	0.001	
C 0431	K22170227	CHIP CAP. GRM40CH470J50PT	47p	
C 0432	K22170227	CHIP CAP. GRM40CH470J50PT	47p	
C 0433	K22170805	CHIP CAP. GRM40B102M50PT	0.001	
D 0401	G2070092	DIODE HVU202-10TRP	HVU202	
D 0402	G2070092	DIODE HVU202-10TRP	HVU202	
D 0403	G2070032	DIODE 1SS153-T2B	1SS153	
J 0401	P0090658	CONNECTOR 9210B-1-11Z009-T		
L 0401	L0021917	CHIP TRANS CS-5 2276-205		
L 0402	L1690004	CHIP COIL LQN2A18NM	0.018u	
L 0403	L1690003	CHIP COIL LQN2AR22K	0.22u	
L 0404	L1690002	CHIP COIL LQN2A22NM	0.022u	
L 0405	L1690055	COIL 32CS 380HB-221K=P	220u	
Q 0401	G3333567	TRANSISTOR 2SC3356-T2B	2SC3356	
Q 0402	G3070028	TRANSISTOR IMX5 T108	IMX5	
Q 0403	G1090870	IC UPB569G	uPB569G	
Q 0404	G3341167G	TRANSISTOR 2SC4116GR TE85R	2SC4116GR	
Q 0405	G1090918	IC MB87076PF-G-BND	MB87076	
R 0401	J24185152	CHIP RES. RMC1/16 152JATP	1.5K	
R 0402	J24185472	CHIP RES. RMC1/16 472JATP	4.7K	
R 0403	J24185472	CHIP RES. RMC1/16 472JATP	4.7K	
R 0404	J24185471	CHIP RES. RMC1/16 471JATP	470	
R 0405	J24185101	CHIP RES. RMC1/16 101JATP	100	
R 0406	J24185473	CHIP RES. RMC1/16 473JATP	47K	
R 0407	J24185471	CHIP RES. RMC1/16 471JATP	470	
R 0408	J24185473	CHIP RES. RMC1/16 473JATP	47K	
R 0409	J24185150	CHIP RES. RMC1/16 150JATP	15	
R 0410	J24185150	CHIP RES. RMC1/16 150JATP	15	

UHF PLL UNIT PARTS LIST

ADD	CODE No.	DESCRIPTION	
R 0411	J24185150	CHIP RES. RMC1/16 150JATP	15
R 0412	J24185104	CHIP RES. RMC1/16 104JATP	100K
R 0413	J24185472	CHIP RES. RMC1/16 472JATP	4.7K
R 0414	J24185104	CHIP RES. RMC1/16 104JATP	100K
R 0415	J24185222	CHIP RES. RMC1/16 222JATP	2.2K
R 0416	J24185220	CHIP RES. RMC1/16 220JATP	22
R 0419	J24185222	CHIP RES. RMC1/16 222JATP	2.2K
R 0420	J24185102	CHIP RES. RMC1/16 102JATP	1K
R 0421	J24185472	CHIP RES. RMC1/16 472JATP	4.7K
R 0422	J24185473	CHIP RES. RMC1/16 473JATP	47K
R 0423	J24185000	CHIP RES. RMC1/16 000JATP	0
TC0401	K91000153	TRIMMER CAP. TZB04Z030BA	3PF 3p

ANT SW UNIT

ANT SW UNIT (No.5XX)

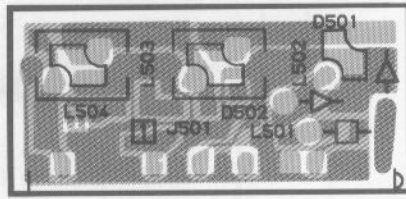

⑬ ← ①

obverse view of "component" side

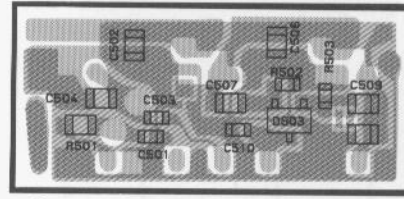

① → ⑬

obverse view of "chip-only" side

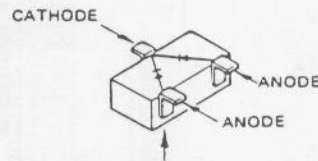

Marked Surface

1SS321(F9) (D503)

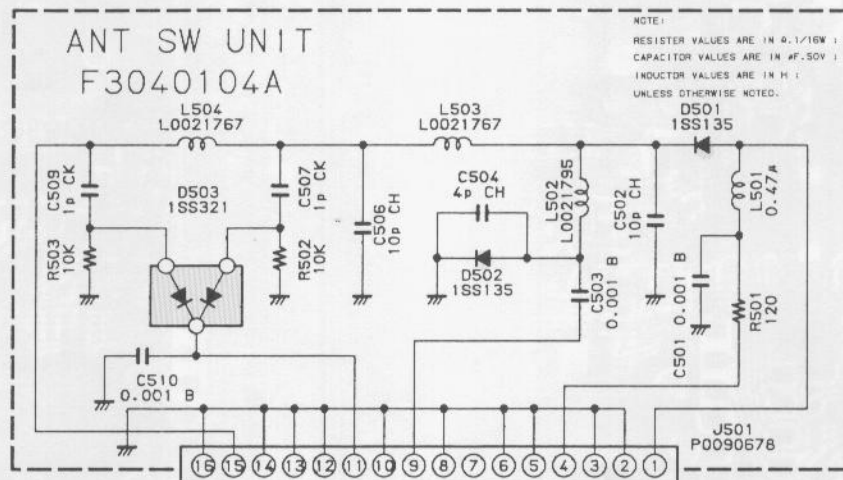

SEMICONDUCTORS

ADD	CODE No.	DESCRIPTION	
CP1108001		PCB with Components	
F3040104		Printed Circuit Board	
C 0501	K22174809	CHIP CAP. GRM39B102M50PT	0.001
C 0502	K22170211	CHIP CAP. GRM40CH100D50PT	10p
C 0503	K22174809	CHIP CAP. GRM39B102M50PT	0.001
C 0504	K22170205	CHIP CAP. GRM40CH040C50PT	4p
C 0506	K22170211	CHIP CAP. GRM40CH100D50PT	10p
C 0507	K22170202	CHIP CAP. GRM40CK010C50PT	1p
C 0509	K22170202	CHIP CAP. GRM40CK010C50PT	1p
C 0510	K22174809	CHIP CAP. GRM39B102M50PT	0.001
D 0501	G2040001	DIODE 1SS135 T-91	1SS135
D 0502	G2040001	DIODE 1SS135 T-91	1SS135
D 0503	G2070076	DIODE 1SS321 TE85R	1SS321
J 0501	P0090678	CONNECTOR 9230B-1-16Z009-T	
L 0501	L1190352	M.RFC LAL02KRR47M	0.47u
L 0502	L0021795	COIL L0021795	
L 0503	L0021767	COIL L0021767	
L 0504	L0021767	COIL L0021767	
R 0501	J24205121	CHIP RES. RMC1/10T 121J	120
R 0502	J24185103	CHIP RES. RMC1/16 103JATP	10K
R 0503	J24185103	CHIP RES. RMC1/16 103JATP	10K

IF, CONNECTOR UNIT PARTS LAYOUT

IF UNIT (No.3XXX)

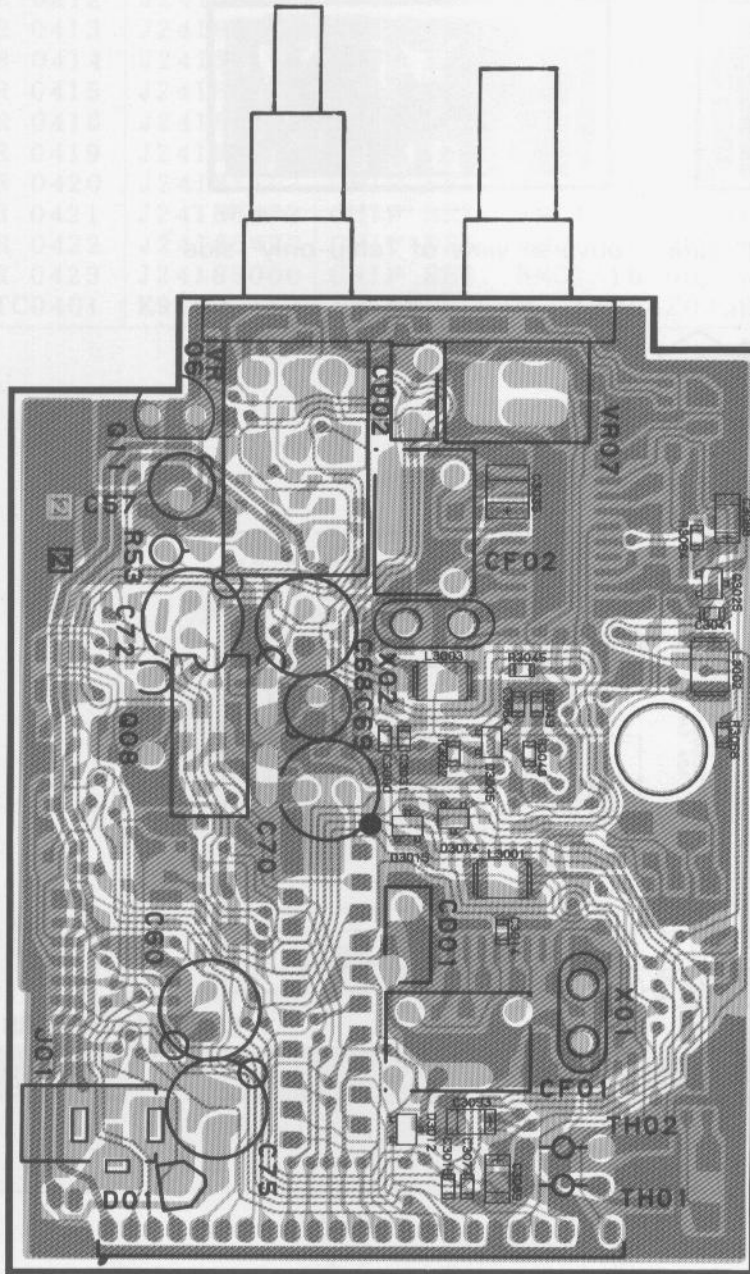

① → 23
obverse view of "component" side

CONNECTOR UNIT (No.6XX)

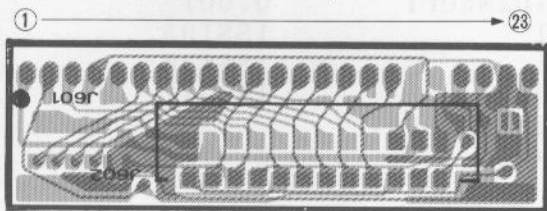

① → 24
② ← 13

obverse view of "component" side

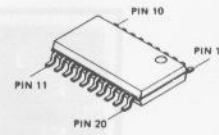

TK10487M (Q3001,3005)

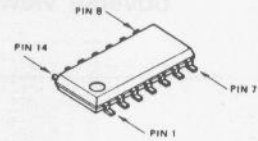

NJM2902M (Q3004)

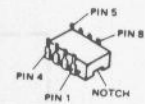

NJM386D (Q3008)

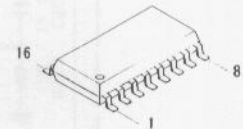

μPD4094BG (Q3012)

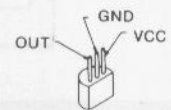

LM2931AZ (Q3011)

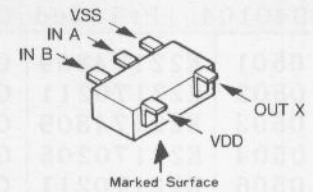

TC4S81F(C2) (Q3026)

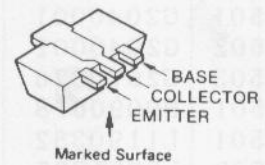

2SB799(ML) (Q3009)

IF, CONNECTOR UNIT PARTS LAYOUT

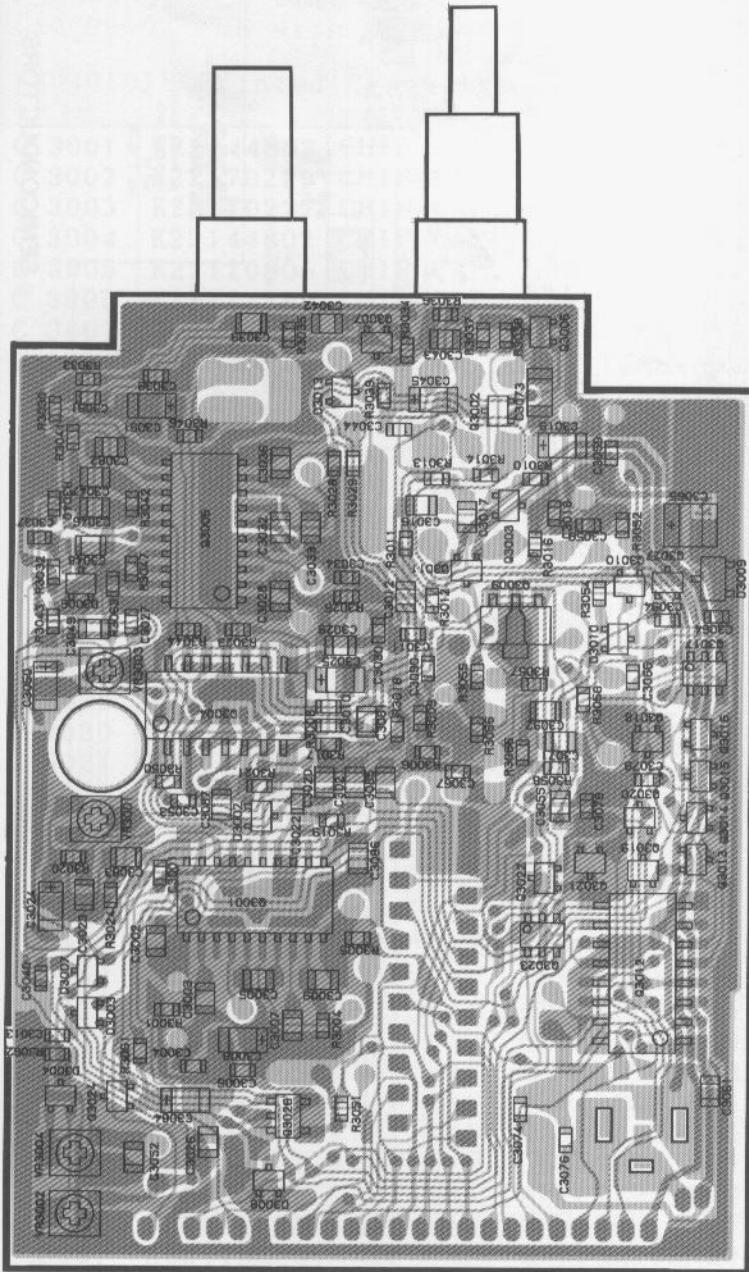

② ← ①

obverse view of "chip-only" side

② ← ①

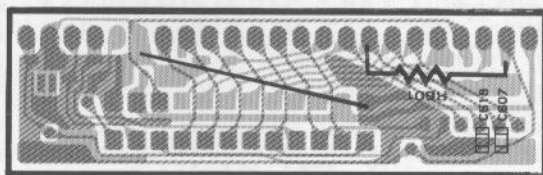

obverse view of "chip-only" side

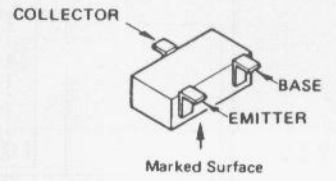

- 2SC4116GR(LG)
(Q3003, 3007, 3010)
- DTA123YU(52)
(Q3013, 3014, 3016, 3019)
3020, 3022
- RN1303(XC)
(Q3002, 3006, 3015, 3018)
3021, 3024, 3025, 3027

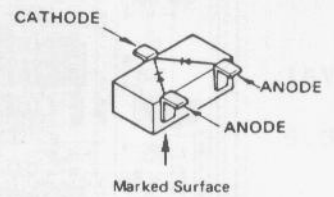

- 1SS301(B3)
(Q3003, 3004, 3005, 3007)
3008, 3010, 3011, 3012
3013, 3014, 3015

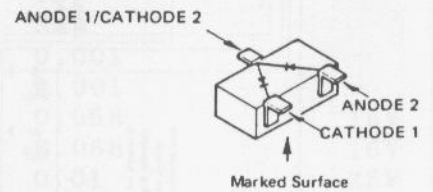

- 1SS302(C3) (D3002, 3006)

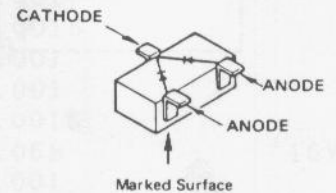

- HZM11A(28) (Q3009)

IF, CONNECTOR UNIT CIRCUIT DIAGRAM

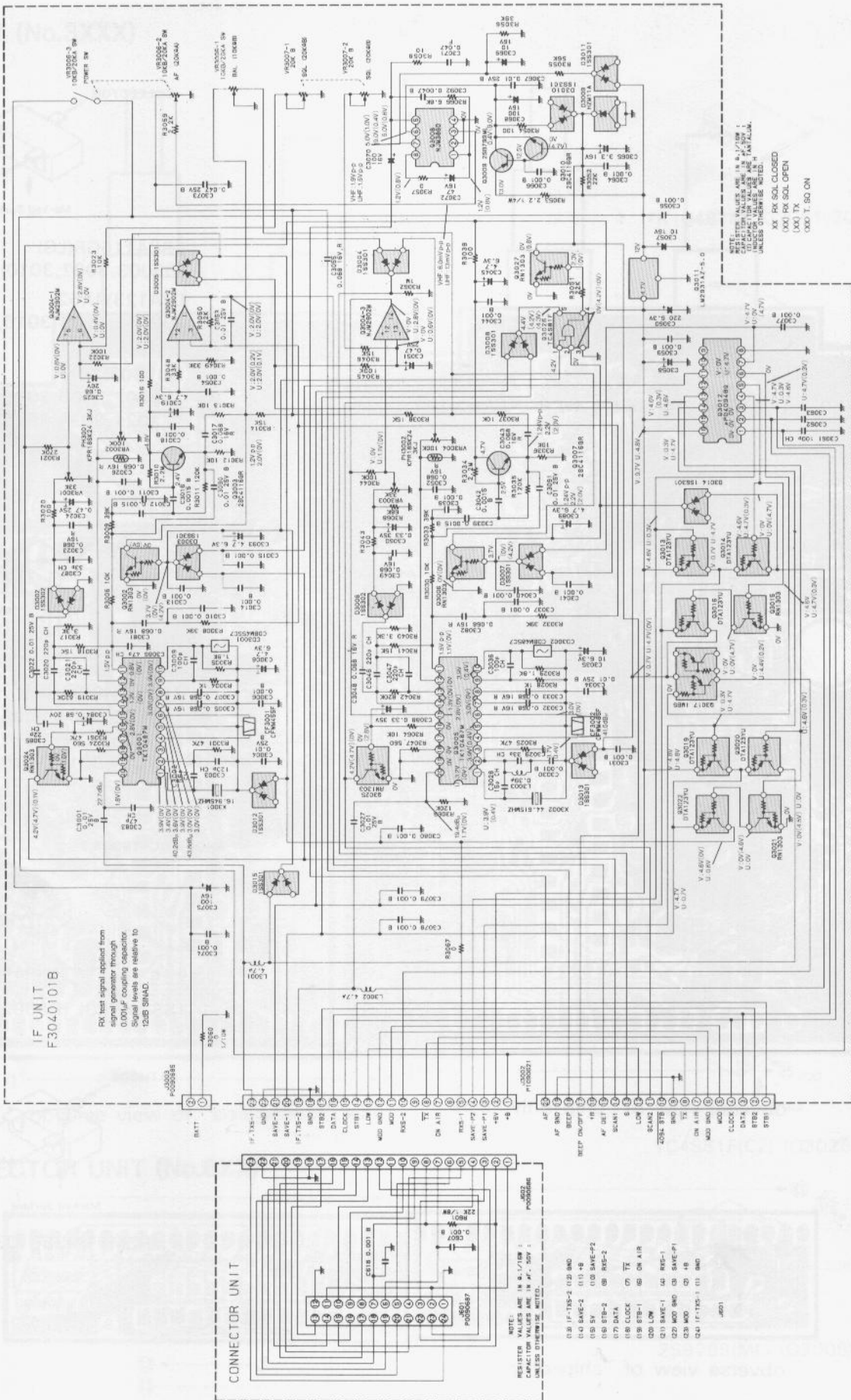

SEMICONDUCTORS

IF UNIT PARTS LIST

ADD	CODE No.	DESCRIPTION		
CS0099002 PCB with Components W/CONNECTER UNIT Ver. A1(EXP)				
CS0099003 PCB with Components W/CONNECTER UNIT Ver. A2(USA)				
F3040101B Printed Circuit Board				
C 3001	K22144802	CHIP CAP. GRM39B103M25PT	0.01	25V
C 3002	K22170229	CHIP CAP. GRM40CH560J50PT	56p	
C 3003	K22170237	CHIP CAP. GRM40CH121J50PT	120p	
C 3004	K22144802	CHIP CAP. GRM39B103M25PT	0.01	25V
C 3005	K22120805	CHIP CAP. GRM40R683M16PT	0.068	16V
C 3006	K22174809	CHIP CAP. GRM39B102M50PT	0.001	
C 3007	K22120805	CHIP CAP. GRM40R683M16PT	0.068	16V
C 3008	K78080017	CHIP TA. CAP. TEMSVA0J475M-8R	4.7	6.3V
C 3009	K22170235	CHIP CAP. GRM40CH101J50PT	100p	
C 3010	K22174809	CHIP CAP. GRM39B102M50PT	0.001	
C 3011	K22174809	CHIP CAP. GRM39B102M50PT	0.001	
C 3012	K22170807	CHIP CAP. GRM40B152M50PT	0.0015	
C 3013	K22174809	CHIP CAP. GRM39B102M50PT	0.001	
C 3014	K22174809	CHIP CAP. GRM39B102M50PT	0.001	
C 3015	K22174809	CHIP CAP. GRM39B102M50PT	0.001	
C 3016	K22170807	CHIP CAP. GRM40B152M50PT	0.0015	
C 3017	K22120805	CHIP CAP. GRM40R683M16PT	0.068	16V
C 3018	K22174809	CHIP CAP. GRM39B102M50PT	0.001	
C 3019	K78080017	CHIP TA. CAP. TEMSVA0J475M-8R	4.7	6.3V
C 3020	K22170243	CHIP CAP. GRM40CH221J50PT	220p	
C 3021	K22170243	CHIP CAP. GRM40CH221J50PT	220p	
C 3022	K22144802	CHIP CAP. GRM39B103M25PT	0.01	25V
C 3023	K22120805	CHIP CAP. GRM40R683M16PT	0.068	16V
C 3024	K78140009	CHIP TA. CAP. TESVA1E474M1-8R	0.47	25V
C 3025	K78130009	CHIP TA. CAP. TESVA1D684M1-8R	0.68	20V
C 3026	K22120805	CHIP CAP. GRM40R683M16PT	0.068	16V
C 3027	K22144802	CHIP CAP. GRM39B103M25PT	0.01	25V
C 3028	K22170215	CHIP CAP. GRM40CH150J50PT	15p	
C 3029	K22170223	CHIP CAP. GRM40CH330J50PT	33p	
C 3030	K22174809	CHIP CAP. GRM39B102M50PT	0.001	
C 3031	K22174809	CHIP CAP. GRM39B102M50PT	0.001	
C 3032	K22120805	CHIP CAP. GRM40R683M16PT	0.068	16V
C 3033	K22120805	CHIP CAP. GRM40R683M16PT	0.068	16V
C 3034	K22144802	CHIP CAP. GRM39B103M25PT	0.01	25V
C 3035	K78080019	CHIP TA. CAP. TEMSVB20J106M-8R	10	6.3V
C 3036	K22170235	CHIP CAP. GRM40CH101J50PT	100p	
C 3037	K22174809	CHIP CAP. GRM39B102M50PT	0.001	
C 3038	K22174809	CHIP CAP. GRM39B102M50PT	0.001	
C 3039	K22170807	CHIP CAP. GRM40B152M50PT	0.0015	
C 3040	K22174809	CHIP CAP. GRM39B102M50PT	0.001	
C 3041	K22174809	CHIP CAP. GRM39B102M50PT	0.001	
C 3042	K22170807	CHIP CAP. GRM40B152M50PT	0.0015	
C 3043	K22120805	CHIP CAP. GRM40R683M16PT	0.068	16V
C 3044	K22174809	CHIP CAP. GRM39B102M50PT	0.001	
C 3045	K78080017	CHIP TA. CAP. TEMSVA0J475M-8R	4.7	6.3V
C 3046	K22170243	CHIP CAP. GRM40CH221J50PT	220p	
C 3047	K22170243	CHIP CAP. GRM40CH221J50PT	220p	
C 3048	K22120805	CHIP CAP. GRM40R683M16PT	0.068	16V
C 3049	K22120805	CHIP CAP. GRM40R683M16PT	0.068	16V
C 3050	K78160028	CHIP TA. CAP. TESVA1V334M1-8R	0.33	35V
C 3051	K78140009	CHIP TA. CAP. TESVA1E474M1-8R	0.47	25V
C 3052	K22120805	CHIP CAP. GRM40R683M16PT	0.068	16V
C 3053	K22144802	CHIP CAP. GRM39B103M25PT	0.01	25V
C 3054	K22174809	CHIP CAP. GRM39B102M50PT	0.001	
C 3055	K22120805	CHIP CAP. GRM40R683M16PT	0.068	16V

IF UNIT PARTS LIST

ADD	CODE No.	DESCRIPTION		
C 3056	K22174809	CHIP CAP. GRM39B102M50PT	0.001	
C 3057	K40129012	AL. ELECTRO. CAP. RC2-16V100M	10	16V
C 3058				
C 3059	K22174809	CHIP CAP. GRM39B102M50PT	0.001	
C 3060	K40089010	AL. ELECTRO. CAP. RC2-6V221M	220	6.3V
C 3061	K22170235	CHIP CAP. GRM40CH101J50PT	100p	
C 3062	K10179024	CERAMIC CAP. CK45B1H103KYS		
C 3063	K10179024	CERAMIC CAP. CK45B1H103KYS		
C 3064	K22174809	CHIP CAP. GRM39B102M50PT	0.001	
C 3065	K78120010	CHIP TA. CAP. TESVB21C335M8R	3.3	16V
C 3066	K22174809	CHIP CAP. GRM39B102M50PT	0.001	
C 3067	K22144802	CHIP CAP. GRM39B103M25PT	0.01	25V
C 3068	K40129038	AL. ELECTRO. CAP. RC2-16V101MS	100	16V
C 3069	K40129012	AL. ELECTRO. CAP. RC2-16V100M	10	16V
C 3070	K40129038	AL. ELECTRO. CAP. RC2-16V101MS	100	16V
C 3071	K22171008	CHIP CAP. GRM40F473Z50PT	0.047	
C 3072	K40129028	AL. ELECTRO. CAP. RC2-16V470M	47	16V
C 3073	K22141808	CHIP CAP. GRM42-6B473M25PT	0.047	25V
C 3074	K22174809	CHIP CAP. GRM39B102M50PT	0.001	
C 3075	K40129038	AL. ELECTRO. CAP. RC2-16V101MS	100	16V
C 3077	K22174809	CHIP CAP. GRM39B102M50PT	0.001	
C 3078	K22174809	CHIP CAP. GRM39B102M50PT	0.001	
C 3079	K22174809	CHIP CAP. GRM39B102M50PT	0.001	
C 3080	K22174809	CHIP CAP. GRM39B102M50PT	0.001	
C 3081	K22120805	CHIP CAP. GRM40R683M16PT	0.068	16V
C 3082	K22120805	CHIP CAP. GRM40R683M16PT	0.068	16V
C 3083	K22170227	CHIP CAP. GRM40CH470J50PT	47p	
C 3084	K78130009	CHIP TA. CAP. TESVA1D684M1-8R	0.68	20V
C 3085	K22170219	CHIP CAP. GRM40CH220J50PT	22p	
C 3086	K22170227	CHIP CAP. GRM40CH470J50PT	47p	
C 3087	K22170223	CHIP CAP. GRM40CH330J50PT	33p	
C 3088	K78160028	CHIP TA. CAP. TESVA1V334M1-8R	0.33	35V
C 3089	K78080017	CHIP TA. CAP. TEMSVA0J475M-8R	4.7	6.3V
C 3090	K22144802	CHIP CAP. GRM39B103M25PT	0.01	25V
C 3091	K22144802	CHIP CAP. GRM39B103M25PT	0.01	25V
C 3092	K22174817	CHIP CAP. GRM39B472M50PT	0.0047	
C 3093	K78080017	CHIP TA. CAP. TEMSVA0J475M-8R	4.7	6.3V
CD3001	H7900480	CERAMIC DISC CDBM455C7	CDBM455C7	
CD3002	H7900540	CERAMIC DISC CDBM485C7	CDBM485C7	
CF3001	H3900395	CERAMIC FILTER CFWM455F	CFWM455F	
CF3002	H3900396	CERAMIC FILTER CFWM485F	CFWM485F	
D 3002	G2070088	DIODE 1SS302 TE85R	1SS302	
D 3003	G2070086	DIODE 1SS301 TE85R	1SS301	
D 3004	G2070086	DIODE 1SS301 TE85R	1SS301	
D 3005	G2070086	DIODE 1SS301 TE85R	1SS301	
D 3006	G2070088	DIODE 1SS302 TE85R	1SS302	
D 3007	G2070086	DIODE 1SS301 TE85R	1SS301	
D 3008	G2070086	DIODE 1SS301 TE85R	1SS301	
D 3009	G2070072	DIODE HZM11A-TR	HZM11A	
D 3010	G2070086	DIODE 1SS301 TE85R	1SS301	
D 3011	G2070086	DIODE 1SS301 TE85R	1SS301	
D 3012	G2070086	DIODE 1SS301 TE85R	1SS301	
D 3013	G2070086	DIODE 1SS301 TE85R	1SS301	
D 3014	G2070086	DIODE 1SS301 TE85R	1SS301	
D 3015	G2070086	DIODE 1SS301 TE85R	1SS301	
J 3002	P1090621	CONNECTOR 52089-2010		
J 3003	P0090685	CONNECTOR 53048-0210		
L 3001	L1690035	COIL 32CS 380LB-4R7M=P	4.7u	
L 3002	L1690035	COIL 32CS 380LB-4R7M=P	4.7u	

IF UNIT PARTS LIST

ADD	CODE No.	DESCRIPTION		
L 3003	L1690066	COIL 32CS 380NB-R39M=P	0.39u	
PH3001	G9090036	POSISTOR KPR18SK24 3KJ	KPR18SK24	3KJ
PH3002	G9090036	POSISTOR KPR18SK24 3KJ	KPR18SK24	3KJ
Q 3001	G1090957	IC TK10487MT1	TK10487M	
Q 3002	G3070037	TRANSISTOR RN1303 TE85R	RN1303	
Q 3003	G3341167G	TRANSISTOR 2SC4116GR TE85R	2SC4116GR	
Q 3004	G1090908	IC NJM2902M	NJM2902M	
Q 3005	G1090957	IC TK10487MT1	TK10487M	
Q 3006	G3070037	TRANSISTOR RN1303 TE85R	RN1303	
Q 3007	G3341167G	TRANSISTOR 2SC4116GR TE85R	2SC4116GR	
Q 3008	G1090920	IC NJM386D	NJM386D	
Q 3009	G3207997L	TRANSISTOR 2SB799-T2ML	2SB799 ML	
Q 3010	G3341167G	TRANSISTOR 2SC4116GR TE85R	2SC4116GR	
Q 3011	G1090785	IC LM2931AZ-5.0	LM2931AZ-5.0	
Q 3012	G1090696	IC UPD4094BG	uPD4094BG	
Q 3013	G3070038	TRANSISTOR DTA123YU T107	DTA123YU	
Q 3014	G3070038	TRANSISTOR DTA123YU T107	DTA123YU	
Q 3015	G3070037	TRANSISTOR RN1303 TE85R	RN1303	
Q 3016	G3070038	TRANSISTOR DTA123YU T107	DTA123YU	
Q 3017	G3070019	TRANSISTOR IMB5 T109	IMB5	
Q 3019	G3070038	TRANSISTOR DTA123YU T107	DTA123YU	
Q 3020	G3070038	TRANSISTOR DTA123YU T107	DTA123YU	
Q 3021	G3070037	TRANSISTOR RN1303 TE85R	RN1303	
Q 3022	G3070038	TRANSISTOR DTA123YU T107	DTA123YU	
Q 3024	G3070037	TRANSISTOR RN1303 TE85R	RN1303	
Q 3025	G3070037	TRANSISTOR RN1303 TE85R	RN1303	
Q 3026	G1090895	IC TC4S81F TE85R	TC4S81F	
Q 3027	G3070037	TRANSISTOR RN1303 TE85R	RN1303	
R 3001	J24185473	CHIP RES. RMC1/16 473JATP	47K	
R 3004	J24185102	CHIP RES. RMC1/16 102JATP	1K	
R 3005	J24185182	CHIP RES. RMC1/16 182JATP	1.8K	
R 3006	J24185103	CHIP RES. RMC1/16 103JATP	10K	
R 3008	J24185393	CHIP RES. RMC1/16 393JATP	39K	
R 3009	J24205393	CHIP RES. RMC1/10T 393J	39K	
R 3010	J24185225	CHIP RES. RMC1/16 225JATP	2.2M	
R 3011	J24185124	CHIP RES. RMC1/16 124JATP	120K	
R 3012	J24185103	CHIP RES. RMC1/16 103JATP	10K	
R 3013	J24185103	CHIP RES. RMC1/16 103JATP	10K	
R 3014	J24185153	CHIP RES. RMC1/16 153JATP	15K	
R 3016	J24185101	CHIP RES. RMC1/16 101JATP	100	
R 3017	J24185332	CHIP RES. RMC1/16 332JATP	3.3K	
R 3018	J24185153	CHIP RES. RMC1/16 153JATP	15K	
R 3019	J24185824	CHIP RES. RMC1/16 824JATP	820K	
R 3020	J24185101	CHIP RES. RMC1/16 101JATP	100	
R 3021	J24185274	CHIP RES. RMC1/16 274JATP	270K	
R 3022	J24185104	CHIP RES. RMC1/16 104JATP	100K	
R 3023	J24185103	CHIP RES. RMC1/16 103JATP	10K	
R 3024	J24185561	CHIP RES. RMC1/16 561JATP	560	
R 3025	J24185473	CHIP RES. RMC1/16 473JATP	47K	
R 3028	J24185102	CHIP RES. RMC1/16 102JATP	1K	
R 3029	J24185182	CHIP RES. RMC1/16 182JATP	1.8K	
R 3030	J24185103	CHIP RES. RMC1/16 103JATP	10K	
R 3032	J24185393	CHIP RES. RMC1/16 393JATP	39K	
R 3033	J24185393	CHIP RES. RMC1/16 393JATP	39K	
R 3034	J24185225	CHIP RES. RMC1/16 225JATP	2.2M	
R 3035	J24185124	CHIP RES. RMC1/16 124JATP	120K	
R 3036	J24185103	CHIP RES. RMC1/16 103JATP	10K	
R 3037	J24185103	CHIP RES. RMC1/16 103JATP	10K	
R 3038	J24185153	CHIP RES. RMC1/16 153JATP	15K	

IF, CONNECTOR UNIT PARTS LIST

ADD	CODE No.	DESCRIPTION	
R 3039	J24185101	CHIP RES. RMC1/16 101JATP	100
R 3040	J24185332	CHIP RES. RMC1/16 332JATP	3.3K
R 3041	J24185153	CHIP RES. RMC1/16 153JATP	15K
R 3042	J24185824	CHIP RES. RMC1/16 824JATP	820K
R 3043	J24185101	CHIP RES. RMC1/16 101JATP	100
R 3044	J24185104	CHIP RES. RMC1/16 104JATP	100K
R 3045	J24185104	CHIP RES. RMC1/16 104JATP	100K
R 3046	J24185153	CHIP RES. RMC1/16 153JATP	15K
R 3047	J24185561	CHIP RES. RMC1/16 561JATP	560
R 3048	J24185333	CHIP RES. RMC1/16 333JATP	33K
R 3049	J24185333	CHIP RES. RMC1/16 333JATP	33K
R 3050	J24185223	CHIP RES. RMC1/16 223JATP	22K
R 3051	J24185223	CHIP RES. RMC1/16 223JATP	22K
R 3052	J24185223	CHIP RES. RMC1/16 223JATP	22K
R 3053	J02245229	CARBON FILM RES.RD14SJ2R2	2.2 2.2
R 3054	J24185101	CHIP RES. RMC1/16 101JATP	100
R 3055	J24185563	CHIP RES. RMC1/16 563JATP	56K
R 3056	J24185393	CHIP RES. RMC1/16 393JATP	39K
R 3057	J24185000	CHIP RES. RMC1/16 000JATP	0
R 3058	J24185100	CHIP RES. RMC1/16 100JATP	10
R 3059	J24185222	CHIP RES. RMC1/16 222JATP	2.2K
R 3060	J24205000	CHIP RES.RMC1/10T 000J	0
R 3061	J24185473	CHIP RES. RMC1/16 473JATP	47K
R 3062	J24185105	CHIP RES. RMC1/16 105JATP	1M
R 3063	J24185124	CHIP RES. RMC1/16 124JATP	120K
R 3064	J24185103	CHIP RES. RMC1/16 103JATP	10K
R 3066	J24205682	CHIP RES.RMC1/10 682J	6.8K
R 3067	J24205000	CHIP RES.RMC1/10T 000J	0
R 3068	J01225683	CARBON FILM RES. RD16PJ683	68K 68K
VR3001	J51778333	POT. RH03AYAN4X 33KB	33K
VR3002	J51778104	POT. RH03AYA15X 100K	100K
VR3003	J51778333	POT. RH03AYAN4X 33KB	33K
VR3004	J51778104	POT. RH03AYA15X 100K	100K
VR3006	J62800102	POT. RK097-5R1211 10KB/20KA	
VR3007	J61800021	VR RK0971220 20KBX2	20K B
X 3001	H0102913	XTAL UM-1 16.845MHZ	16.845MHZ
X 3002	H0102917	XTAL UM-1 44.615MHZ	44.615MHZ

ADD	CODE No.	DESCRIPTION	
CP1114001 PCB with Components			
F3039102A Printed Circuit Board			
C 0601	K22174809	CHIP CAP. GRM39B102M50PT	0.001
C 0618	K22174809	CHIP CAP. GRM39B102M50PT	0.001
J 0601	P0090687	CONNECTOR 53020-2410	24PIN
J 0602	P0090686	CONNECTOR 9230B-1-23Z009-T	23PIN
R 0601	J01215223	CARBON FILM RES.RD18TJ223	22K 1/8W

(Version B, Only) T-BURST UNIT

T-BURST UNIT (No.8XX)

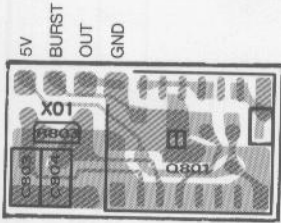

obverse view of "IC" side

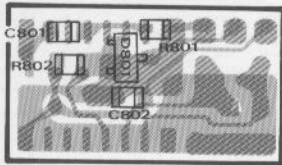

obverse view of "Diode" side

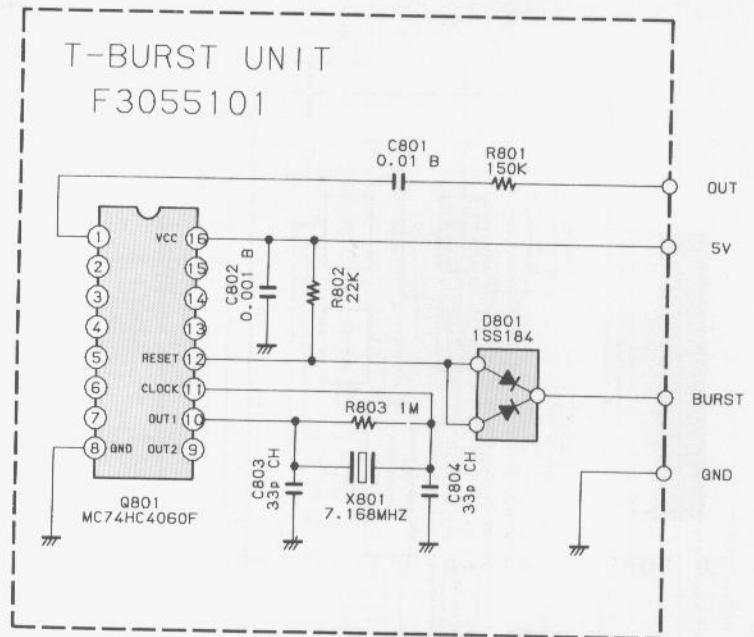

SEMICONDUCTORS

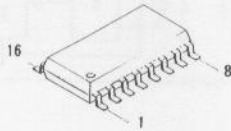

MC74HC4060FL (Q801)

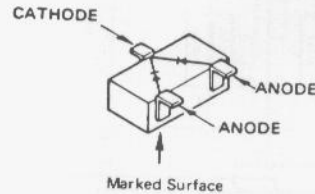

1SS184(B3) (D801)

ADD	CODE No.	DESCRIPTION
CP1875000 PCB with Components		
F3055101A Printed Circuit Board		
C 0801	K22170817	CHIP CAP. GRM40B103M50PT 0.01
C 0802	K22174809	CHIP CAP. GRM39B102M50PT 0.001
C 0803	K22170223	CHIP CAP. GRM40CH330J50PT 33p
C 0804	K22170223	CHIP CAP. GRM40CH330J50PT 33p
D 0801	G2070009	DIODE 1SS184 TE85R 1SS184
Q 0801	G1090984	IC MC74HC4060FL MC74HC4060F
R 0801	J24185154	CHIP RES. RMC1/16 154JATP 150K
R 0802	J24185223	CHIP RES. RMC1/16 223JATP 22K
R 0803	J24185105	CHIP RES. RMC1/16 105JATP 1M
X 0801	H0102930	XTAL UM-1 7.168MHZ 7.168MHZ

BLOCK DIAGRAM

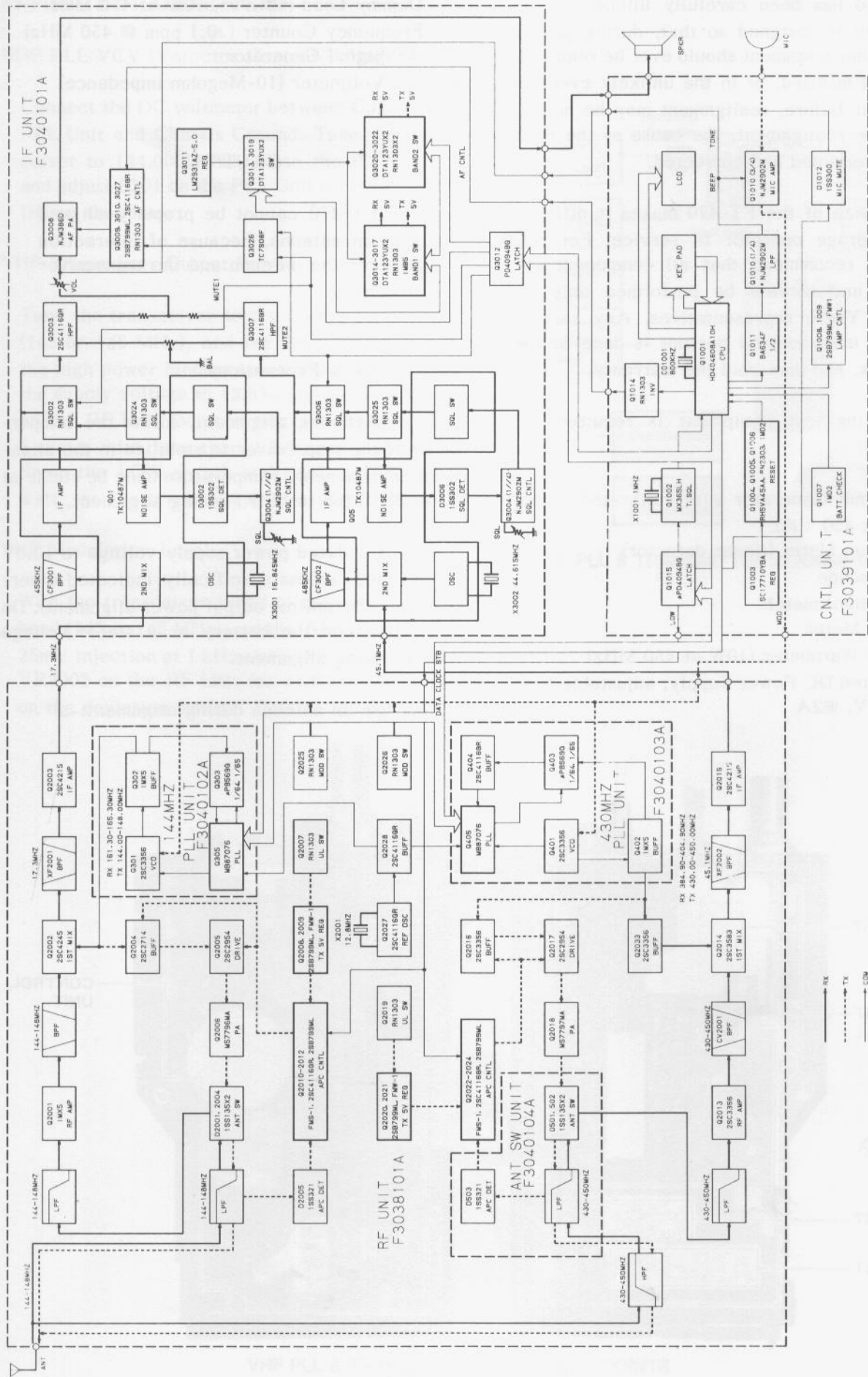

FT-470
BLOCK DIAGRAM

ALIGNMENT

The FT-470 has been carefully aligned at the factory, and is designed so that, during proper use, no further alignment should ever be required. However, if misused, or in the unlikely event of a component failure, realignment may be necessary. Before realignment, the cause of the fault must be determined and corrected.

The small size of the FT-470 makes it difficult for the average operator to service. For this reason, we recommend that all component replacement and service be performed only by authorized Yaesu representatives. Any service attempt by unauthorized persons is done at the owner's risk, and may void the warranty.

The following test equipment is required for alignment:

- RF Signal Generator with calibrated output level at 450 MHz
- Deviation Meter (linear detector)
- Oscilloscope
- AF Millivoltmeter
- SINAD Meter
- In-Line Wattmeter (10W at 450 MHz)
- Regulated DC Power Supply, adjustable from 4 to 17V, @2A

- Dummy Load (50-ohm, 10W at 450 MHz)
- Frequency Counter (± 0.1 ppm @ 450 MHz)
- AF Signal Generator
- DC Voltmeter (10-Megohm impedance)

CAUTION!

The FT-470 cannot be properly aligned with an antenna, because of interaction between the antenna and the transceiver circuitry.

Preparation & Precautions

Before beginning alignment, allow the temperature of the transceiver to stabilize in the alignment environment. Temperature must be stable at 20 to 30 °C (68 to 86 °F) during alignment.

Set the regulated power supply voltage to 13.8V for all steps unless specifically indicated otherwise (for transmitter output power alignment). Do not depend on the battery as a stable voltage source during alignment.

Do not use an antenna during alignment.

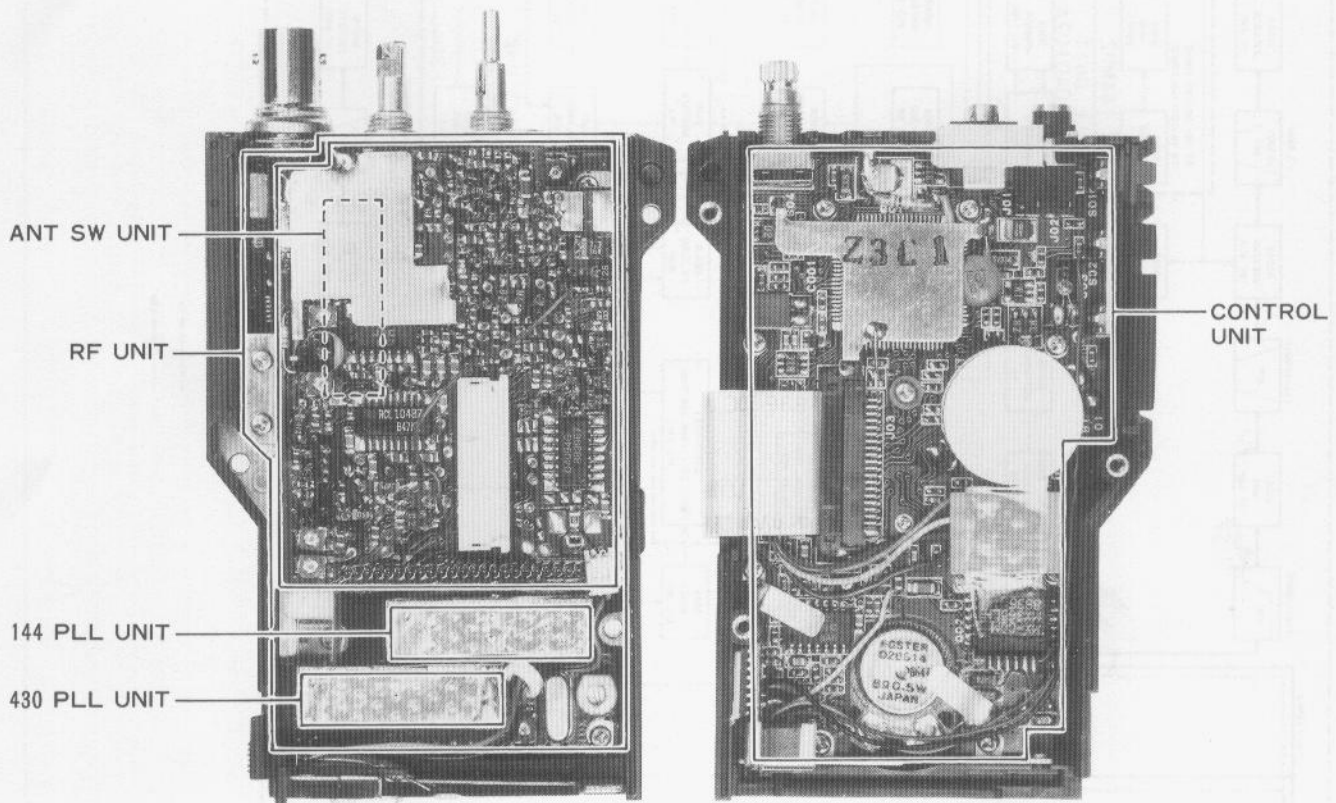

BOARD LOCATIONS

(VHF PLL & Transmitter) ALIGNMENT

VHF PLL & TRANSMITTER

VHF PLL VCV (Varactor Control Voltage)

Connect the DC voltmeter between C325 on the PLL Unit and Chassis Ground. Tune the transceiver to 144.000 MHz, close the PTT switch and adjust L301 on the PLL Unit for $0.92 \pm 0.05V$ DC on the meter.

VHF Transmitter Output Power

Tune the transceiver to the center of the band (145 or 146 MHz), and set the LOW switch to the high power (undepressed) position. Increase the supply voltage to 13.8V, and adjust VR2003 on the RF Unit for peak output power (at least 5 watts with less than 1.5A supply current). Press the LOW switch and confirm 0.3 to 1.0 watt, then return the supply voltage to 12V.

VHF Modulation Level

With the transceiver tuned to the center of the band (145 or 146 MHz), set the AF generator for 25mV injection at 1 kHz to the MIC jack. Adjust VR2002 on the RF Unit for ± 4.5 kHz deviation on the deviation meter.

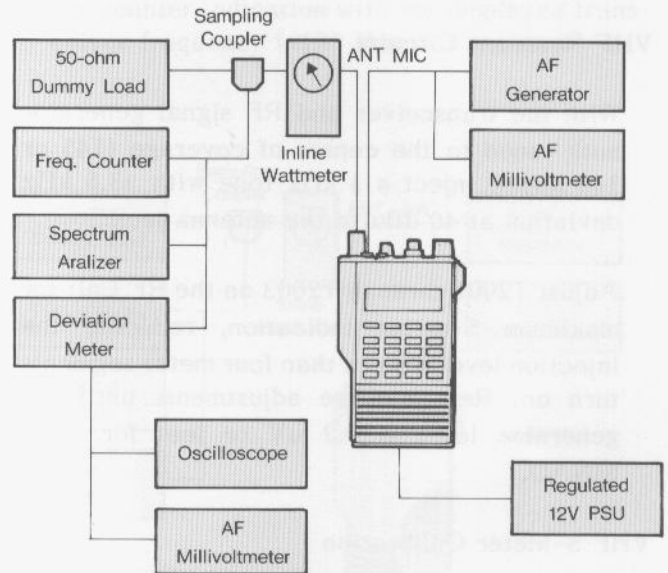

VHF PLL & TRANSMITTER ALIGNMENT SETUP

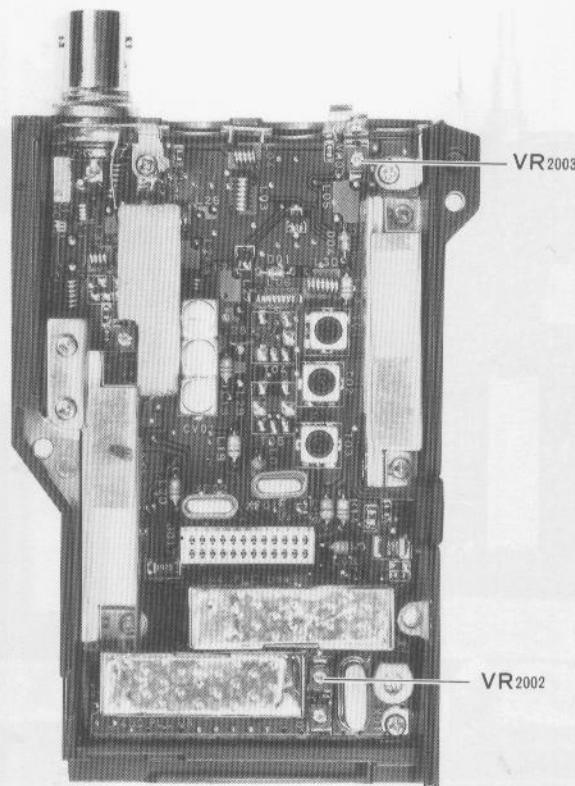

VHF PLL & TRANSMITTER ALIGNMENT POINTS

ALIGNMENT (VHF Receiver)

VHF RECEIVER

Set up the test equipment as shown above for receiver alignment.

VHF Resonant Circuits

With the transceiver and RF signal generator both tuned to the center of coverage (145 or 146 MHz), inject a 1 kHz tone with ± 3.5 kHz deviation at 40 dBu to the antenna jack.

Adjust T2001 through T2003 on the RF Unit for maximum S-meter indication, reducing the injection level if more than four meter segments turn on. Repeat these adjustments until the generator level is 0.2 μ V or less for 12dB SINAD.

VHF S-Meter Calibration

At the center of the band, set the signal generator for 15dBu (2.8 μ V) injection with ± 3 kHz deviation of a 1 kHz tone.

Adjust VR3002 so that all S-meter segments are just on.

VHF Squelch Preset

With the transceiver tuned to the center of the VHF band, set the SQL control on the top panel to the 11 o'clock position. Reduce the RF generator level at the ANT jack to nil (but do not disconnect it, to maintain a 50-ohm termination).

Adjust VR3001 on the IF Unit so that the squelch just closes.

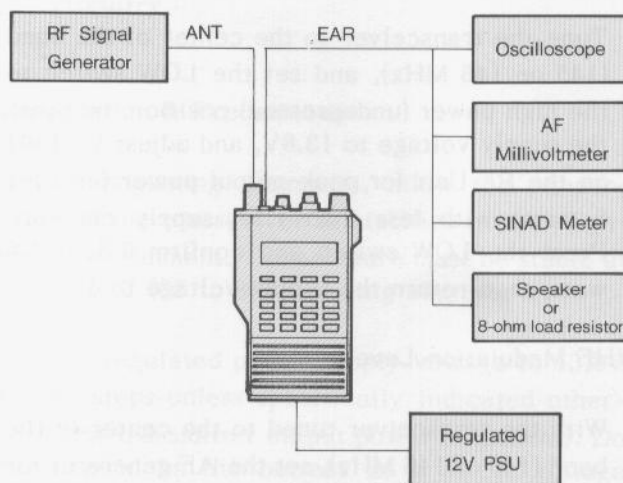

VHF RECEIVER ALIGNMENT SETUP

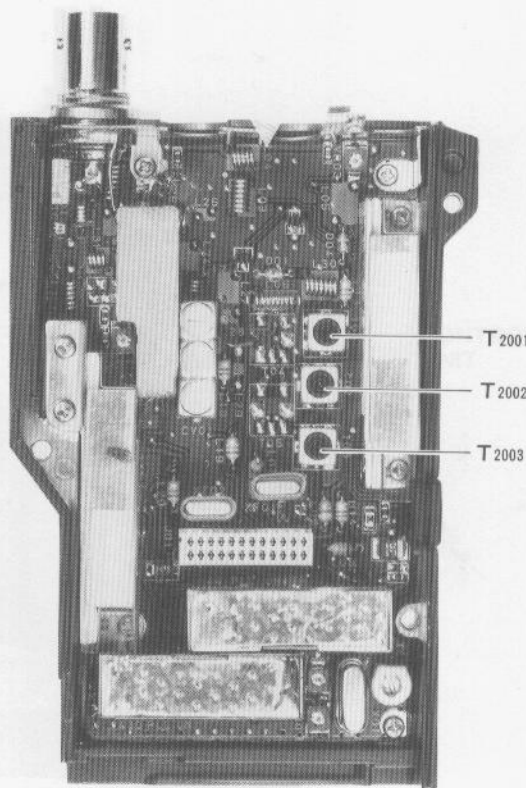
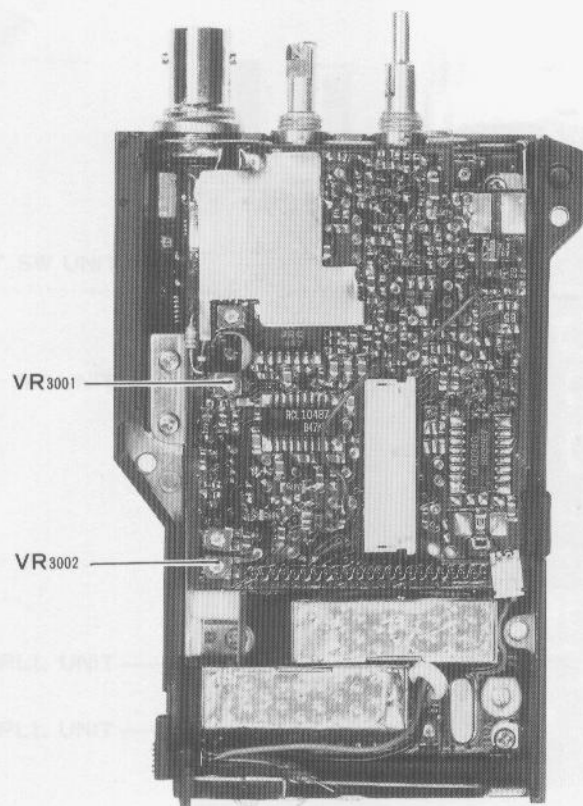

VHF RECEIVER ALIGNMENT POINTS

ALIGNMENT (UHF PLL & Transmitter)

UHF PLL & TRANSMITTER

UHF PLL VCV (Varactor Control Voltage)

Connect the DC voltmeter between C425 on the PLL Unit and Chassis Ground. Tune the transceiver to 450.000 MHz, close the PTT switch and adjust L301 on the PLL Unit for $4.0 \pm 0.05V$ DC on the meter.

UHF Transmitter Output Power

Tune the transceiver to the center of the band (440 MHz), and set the LOW switch to the high power (undepressed) position. Increase the supply voltage to 13.8V, and adjust VR2004 on the RF Unit for peak output power (at least 5 watts with less than 1.7A supply current). Press the LOW switch and confirm 0.3 to 1.0 watt, then return the supply voltage to 12V.

UHF Modulation Level

With the transceiver tuned to the center of the band (440 MHz), set the AF generator for 25mV injection at 1 kHz to the MIC jack. Adjust VR2001 on the RF Unit for ± 4.5 kHz deviation on the deviation meter.

UHF Frequency Alignment

Set the transceiver to the high edge of the band and adjust TC2001 on the Main Unit to match the counter indication with the displayed transceiver frequency (± 100 Hz).

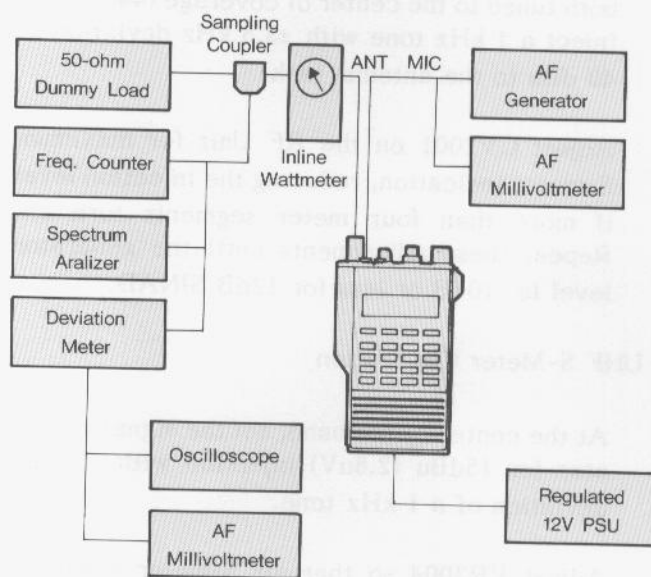

UHF PLL & TRANSMITTER ALIGNMENT SETUP

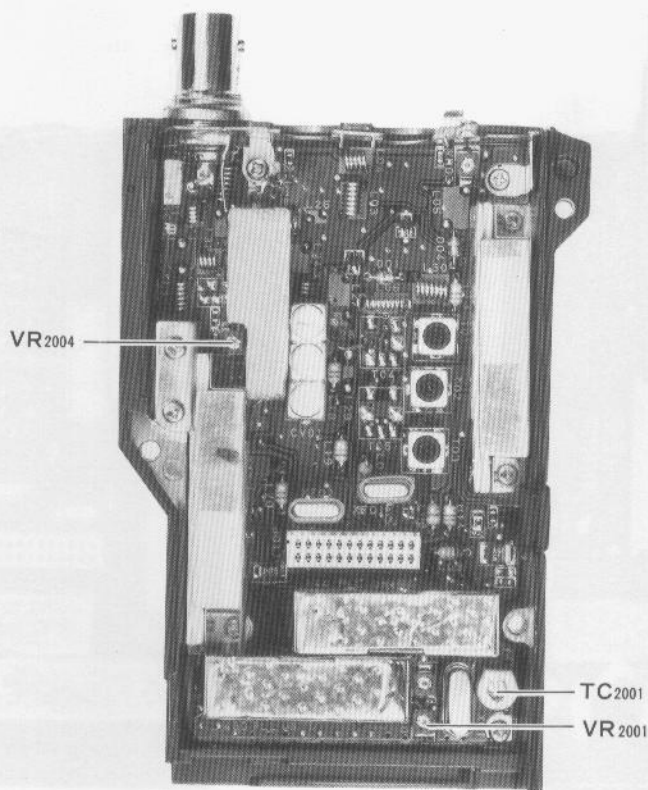

UHF PLL & TRANSMITTER ALIGNMENT POINTS

ALIGNMENT (UHF Receiver)

UHF RECEIVER

Set up the test equipment as shown above for receiver alignment.

UHF Bandpass Filter

With the transceiver and RF signal generator both tuned to the center of coverage (440 MHz), inject a 1 kHz tone with ± 3.5 kHz deviation at 40 dBu to the antenna jack.

Adjust CV2001 on the RF Unit for maximum S-meter indication, reducing the injection level if more than four meter segments turn on. Repeat these adjustments until the generator level is -10dB or less for 12dB SINAD.

UHF S-Meter Calibration

At the center of the band, set the signal generator for 15dBu (2.8uV) injection with ± 3 kHz deviation of a 1 kHz tone.

Adjust VR3004 so that all S-meter segments are just on.

UHF Squelch Preset

With the transceiver tuned to the center of the UHF band, set the SQL control on the top panel to the 11 o'clock position. Reduce the RF generator level at the ANT jack to nil (but do not disconnect it, to maintain a 50-ohm termination).

Adjust VR3003 on the IF Unit so that the squelch just closes.

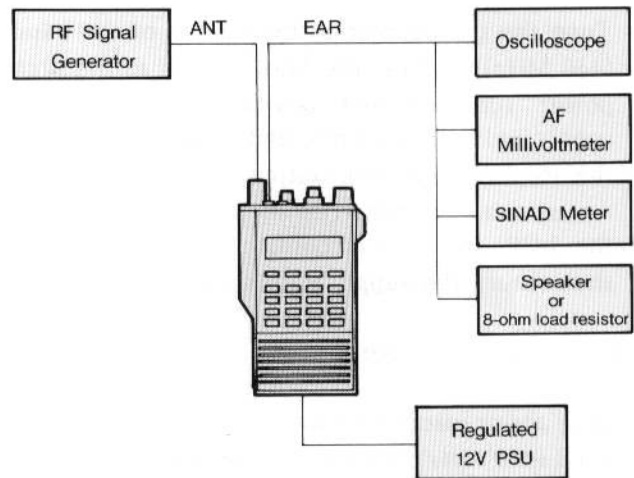

UHF RECEIVER ALIGNMENT SETUP

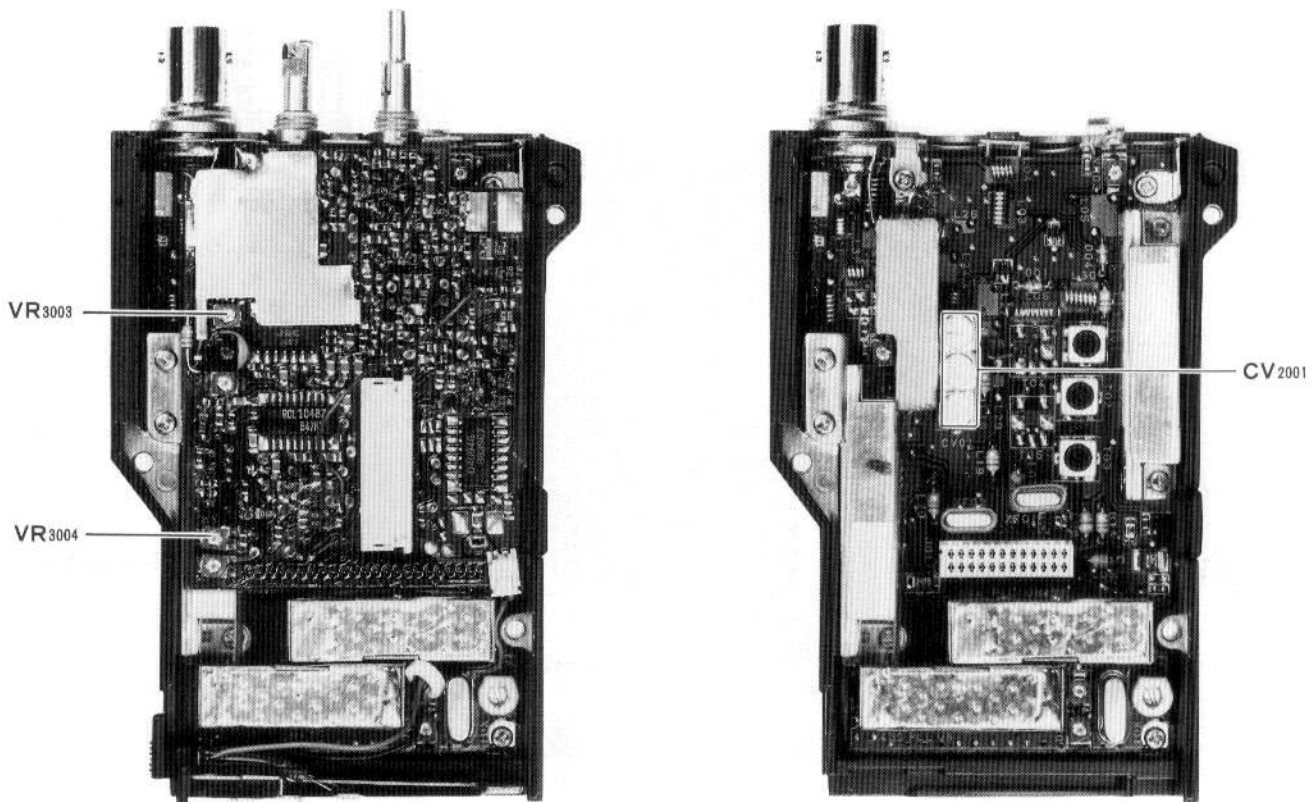

UHF RECEIVER ALIGNMENT POINTS