



Dual Band FM Transceiver

FT-8800R

Technical Supplement

© 2003 VERTEX STANDARD CO., LTD. (EH018M90A)

VERTEX STANDARD CO., LTD.
4-8-8 Nakameguro, Meguro-Ku, Tokyo 153-8644, Japan

VERTEX STANDARD
US Headquarters
10900 Walker Street, Cypress, CA 90630, U.S.A.
International Division
8350 N.W. 52nd Terrace, Suite 201, Miami, FL 33166, U.S.A.

YAESU EUROPE B.V.
P.O. Box 75525, 1118 ZN Schiphol, The Netherlands

YAESU UK LTD.
Unit 12, Sun Valley Business Park, Winnall Close
Winchester, Hampshire, SO23 0LB, U.K.

VERTEX STANDARD HK LTD.
Unit 5, 20/F., Seaview Centre, 139-141 Hoi Bun Road,
Kwun Tong, Kowloon, Hong Kong

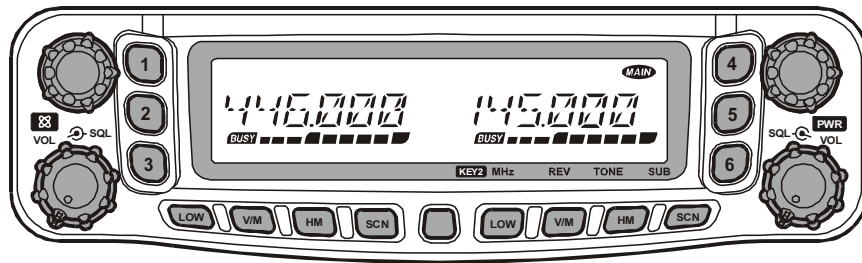

Introduction

This manual provides technical information necessary for servicing the FT-8800R Transceiver.

Servicing this equipment requires expertise in handling surface-mount chip components. Attempts by non-qualified persons to service this equipment may result in permanent damage not covered by the warranty, and may be illegal in some countries.

Two PCB layout diagrams are provided for each double-sided circuit board in the transceiver. Each side of the board is referred to by the type of the majority of components installed on that side (“leaded” or “chip-only”). In most cases one side has only chip components, and the other has either a mixture of both chip and leaded components (trimmers, coils, electrolytic capacitors, ICs, etc.), or leaded components only.

While we believe the technical information in this manual to be correct, Vertex Standard assumes no liability for damage that may occur as a result of typographical or other errors that may be present. Your cooperation in pointing out any inconsistencies in the technical information would be appreciated.

Contents

Specifications	2
Exploded View & Miscellaneous Parts	3
Block Diagram	5
Circuit Description	7
Alignment	11

Board Unit (Schematics, Layouts & Parts)

Main Unit	17
Panel Unit	45
Panel-Sub Unit	51
VR-L Unit	53
VR-R Unit	54

Specifications

GENERAL

Frequency Range:	RX: 108.000 - 520.000 MHz, 700.000 - 999.995 MHz (Cellular Blocked)
	TX: 144.000 - 146.000 MHz (or 144.000 - 148.000 MHz), 430.000 - 440.000 MHz (or 430.00 - 450.000 MHz)
Channel Steps:	5/10/12.5/15/20/25/50 kHz
Modes of Emission:	F3, F2
Antenna Impedance:	50-Ohms, unbalanced (Antenna Duplexer built-in)
Frequency Stability:	±5 ppm @ 14° F ~ +140° F (-10 °C ~ +60 °C)
Operating Temperature Range:	-4° F ~ +140° F (-20 °C ~ +60 °C)
Supply Voltage:	13.8 VDC (±15%), negative ground
Current Consumption (Approx.):	RX: 0.5 A (Squelched) TX: 8.5 A (144 MHz), 8.0 A (430 MHz)
Case Size (W x H x D):	5.5" x 1.6" x 6.6" (140 x 41.5 x 168 mm) (w/o knobs & connectors)
Weight (Approx.):	2.2 lb (1 kg)

TRANSMITTER

Output Power:	50/20/10/5 W (144 MHz), 35/20/10/5 W (430 MHz)
Modulation Type:	Variable Reactance
Maximum Deviation:	±5 kHz
Spurious Radiation:	Better than -60 dB
Microphone Impedance:	2 kΩ
DATA Jack Impedance:	10 kΩ

RECEIVER

Circuit Type:	Double-conversion superheterodyne
Intermediate Frequencies:	45.05 MHz/450 kHz (Main band), 47.25 MHz/450 kHz (Sub band)
Sensitivity (for 12dB SINAD):	Better than 0.2 μV
Squelch Sensitivity:	Better than 0.16 μV
Selectivity (-6dB/-60dB):	8 kHz/30 kHz
Maximum AF Output:	2 W @ 8 Ω for 5% THD
AF Output Impedance:	4-16 Ω

Specifications are subject to change without notice, and are guaranteed within the 144 and 430 MHz amateur bands only. Frequency ranges will vary according to transceiver version; check with your dealer.

Exploded View & Miscellaneous Parts

Note:

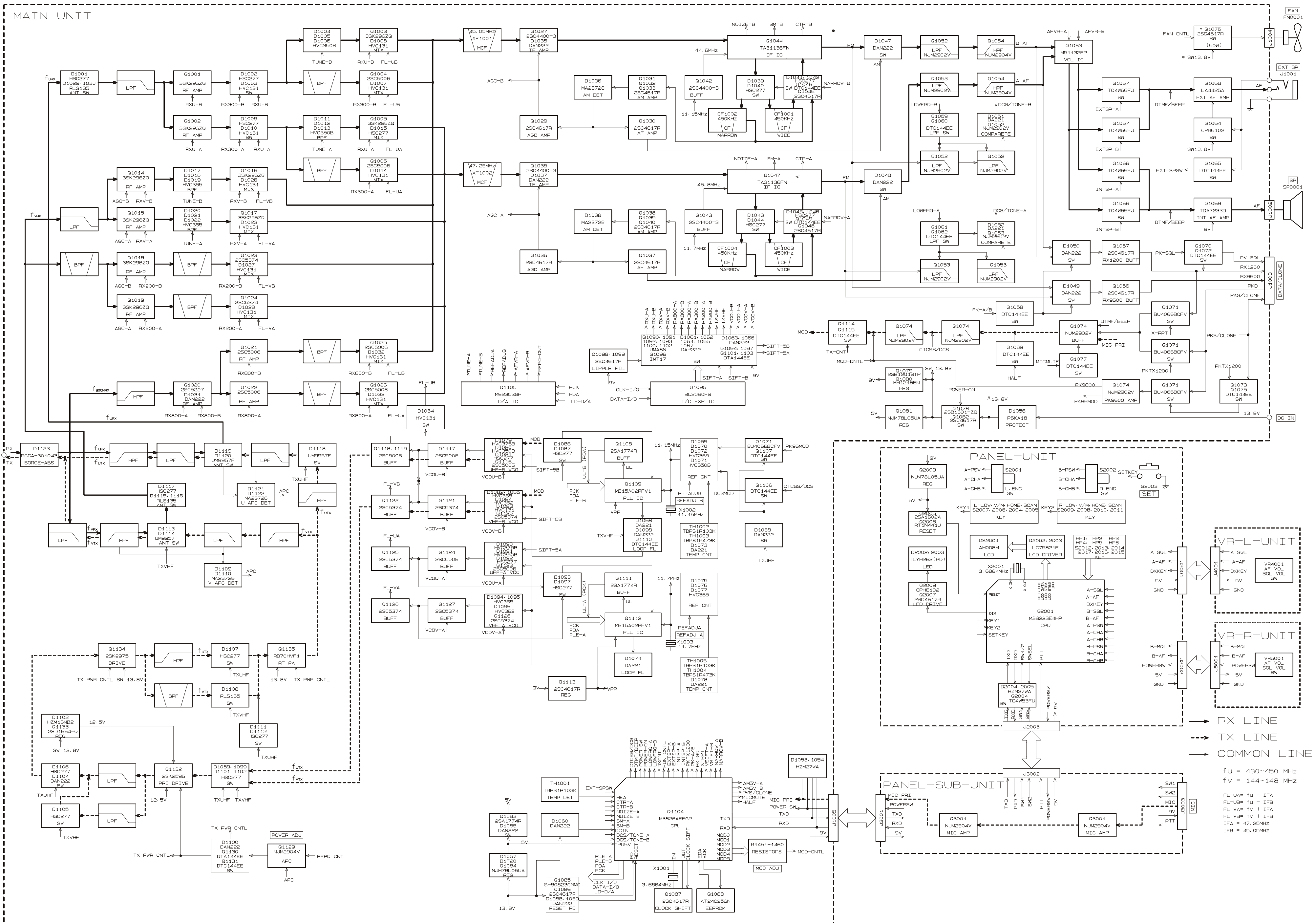

Block Diagram

Note:

Receiver Signal Path

“Main” Band 430 MHz Signal

The 430 MHz signal is passed through a high-pass filter network and a low-pass filter network to the antenna switch diodes **D1029**, **D1030** (both **RSL135**) and **D1001** (**HSC277TRF**), then passed through another low-pass filter network to the “Main” band RF amplifier **Q1001** (**3SK296ZQ**).

The amplified 430 MHz signal is passed through the band switch **D1002** (**HSC277**) to the varactor-tuned band-pass filter network consisting of **D1004**, **D1005**, and **D1006** (all **HVC350B**) and associated circuitry, then applied to the first mixer **Q1003** (**3SK296ZQ**). Meanwhile, the UHF local signal from the UHF-VCO/B **Q1116** (**2SC5006**) is delivered to first mixer **Q1003**, yielding the 45.05 MHz “Main” band first IF.

“Main” Band 144 MHz Signal

The 144 MHz signal is passed through a low-pass filter network and a high-pass filter network to the antenna switch diodes **D1113**, **D1114** (both **UM9957F**), **D1115**, **D1116** (both **RLS135**) and **D1117** (both **RLS135**) then passed through another low-pass filter network to the “Main” band RF amplifier **Q1014** (**3SK296ZQ**).

The amplified 144 MHz signal is passed through a varactor-tuned band-pass filter network consisting of **D1017**, **D1018**, **D1019** (all **HVC365**) and associated circuitry to the first mixer **Q1016** (**3SK296ZQ**). Meanwhile, the VHF local signal from the VHF-VCO/B **Q1120** (**2SC5374**) is delivered to first mixer **Q1016**, yielding the 45.05 MHz “Main” band first IF.

“Main” Band IF and AF Signals

The 45.05 MHz “Main” band first local signal is delivered to the monolithic crystal filter **XF1001** which strips away unwanted mixer products, then is passed through IF amplifier **Q1027** (**2SC4400**) to the IF IC **Q1044** (**TA31136FN**).

Meanwhile, a portion of the output of 11.15 MHz crystal **X1002** is multiplied fourfold by **Q1042** (**2SC4400**) to provide the 44.6 MHz second local signal, then delivered to the IF IC **Q1044**. Within the IF IC **Q1044**, the 44.6 MHz second local signal is mixed with the 45.05 MHz “Main” band first local signal to produce the 450 kHz “Main” band second IF.

The 450 kHz “Main” band second IF is passed through the filter switch **D1039/D1041** (both **HSC277**) to the ceramic filter **CF1001** (**CFWM450E**) which strips away all but the desired signal, then it passes through the IF amplifier within **Q1044** to the ceramic discriminator **CD1001** (**CDBM450C24**), which removes any amplitude variations in the 450 kHz IF signal before detection of speech.

The demodulated “Main” band audio is passed through the de-emphasis network, audio switch **D1047** (**DAN222**), low-pass filter network (consisting of **Q1052** (**NJM2902V**) and associated circuitry), and a high-pass filter network (consisting of **Q1054** (**NJM2904V**) and associated circuitry). The filtered audio signal is passed through the audio volume control IC **Q1063** (**M51132FP**), which adjusts the audio sensitivity to compensate for audio level variations, then is delivered to the audio switch **Q1066** and **Q1067** (both **TC4W66FU**).

When the internal speaker is selected, the audio signal is amplified by **Q1069** (**TDA7233D**) then applied to the internal loudspeaker. When the external speaker is selected, the audio signal is amplified by **Q1068** (**LA4425A**), then it passes through the **EXT SP** jack to the external loudspeaker.

“Sub” Band 430 MHz Signal

The 430 MHz signal is passed through a high-pass filter network and a low-pass filter network to the antenna switch diodes **D1029**, **D1030** (both **RSL135**) and **D1001** (**HSC277TRF**), then passed through another low-pass filter network to the “Sub” band RF amplifier **Q1002** (**3SK296ZQ**).

The amplified 430 MHz signal is delivered through the band switch **D1009** (**HSC277**) to the varactor-tuned band-pass filter network consisting of **D1011**, **D1012**, **D1013** (all **HVC350B**) and associated circuitry, then applied to the first mixer **Q1005** (**3SK296ZQ**). Meanwhile, the UHF local signal from the UHF-VCO/A **Q1123** (**2SC5006**) is delivered to first mixer **Q1005**, yielding the 47.25 MHz “Sub” band first IF.

“Sub” Band 144 MHz Signal

The 144 MHz signal is passed through a low-pass filter network and a high-pass filter network to the antenna switch diodes **D1113**, **D1114** (both **UM9957F**), **D1115**, **D1116** (both **RLS135**) and **D1117** (both **RLS135**), then passed through another low-pass filter network to the “Sub” band RF amplifier **Q1015** (**3SK296ZQ**).

The amplified 144 MHz signal is passed through the varactor-tuned band-pass filter network consisting of **D1020**, **D1021**, **D1022** (all **HVC365**) and associated circuitry to the first mixer **Q1017** (**3SK296ZQ**). Meanwhile, the VHF local signal from the VHF-VCO/A **Q1126** (**2SC5374**) is delivered to first mixer **Q1017**, yielding the 47.25 MHz “Sub” band first IF.

“Sub” Band IF and AF Signal

The 47.25 MHz “Sub” band first IF is delivered to the monolithic crystal filter **XF1002** which strips away unwanted mixer products, then passed through the IF amplifier **Q1035** (**2SC4400**) to the IF IC **Q1047** (**TA31136FN**).

Circuit Description

Meanwhile, a portion of the output of 11.7 MHz crystal **X1003** is multiplied fourfold by **Q1043 (2SC4400)** to provide the 46.8 MHz second local signal, then applied to the IF IC **Q1047**. Within the IF IC **Q1047**, the 46.8 MHz second local signal is mixed with the 47.25 MHz “Sub” band first local signal to produce the 450 kHz “Sub” band second IF.

The 450 kHz “Sub” band second IF is delivered to the ceramic filter **CF1003 (CFWM450E)** which strips away all but the desired signal, then passed through the IF amplifier within **Q1047** to the ceramic discriminator **CD1002 (CDBM450C24)** which removes any amplitude variations in the 450 kHz IF signal before detection of speech.

The demodulated “Sub” band audio is passed through the de-emphasis network, audio switch **D1048 (DAN222)**, low-pass filter network (consisting of **Q1053 (NJM2902V)** and associated circuitry) and the high-pass filter network (consisting of **Q1054 (NJM2904V)** and associated circuitry). The filtered audio signal is passed through the audio volume control IC **Q1063 (M511312FP)**, which adjusts the audio sensitivity to compensate for audio level variations, then is delivered to the audio switch **Q1066** and **Q1067** (both **TC4W66FU**).

When the internal speaker is selected, the audio signal is amplified by **Q1069 (TDA7233D)** then applied to the internal loudspeaker. When the external speaker is selected, the audio signal is amplified by **Q1068 (LA4425A)**, then it passes through the **EXT SP** jack to the external loudspeaker.

Squelch Control

“Main” Band

When no carrier is being received on the “Main” band, noise at the output of the detector stage in **Q1044** is amplified and band-pass filtered by the noise amp section of **Q1044**. The resulting DC voltage is delivered to pin 5 of main CPU **Q1104 (M38268MCL)**, which compares the squelch threshold level to that which set by the front panel **SQL** knob.

While no carrier is being received on the “Main” band, pin 2 of **Q1105** remain “low,” to disable the audio output from the speaker.

“Sub” Band

When no carrier is being received on the “Sub” band, noise at the output of the detector stage in **Q1047** is amplified and band-pass filtered by the noise amp section of **Q1047**. The resulting DC voltage is delivered to pin 2 of main CPU **Q1104**, which compares the squelch threshold level to that which set by the front panel **SQL** knob.

While no carrier is being received on the “Right” band, pin 15 of **Q1105** remain “low,” to disable the audio output from the speaker.

Transmitter Signal Path

AF Signal

The speech signal from the microphone is passed through the **MIC** jack **J3003** to the AF amplifier **Q3001 (NJM2904V)** on the **PANEL-SUB** UNT. The amplified speech signal is passed through the panel separation jacks **J3001** and **J1005** to the **MAIN** Unit. On the **MAIN** UNIT, the speech signal is delivered to the limiting amplifier **Q1074 (NJM2902V)** to prevent over-modulation, then is delivered to a low-pass filter network consisting of **Q1074** and associated circuitry.

430 MHz Signal

The adjusted speech signal from **Q1074** is passed through transistor switch **Q1114, Q1115** (both **DTC144EE**) to varactor diodes **D1079 (HVC375B)** and **D1080 (HVC350B)**, which frequency modulate the transmitting VCO, made up of UHF-VCO/B **Q1116 (2SC5006)** and **D1081 (HSC277)**.

The modulated transmit signal is passed through buffer amplifiers **Q1117, Q1118** and **Q1119** (all **2SC5006**) and diode switches **D1099, D1101** (both **HSC277**) to the pre-drive amplifier **Q1132 (2SK2596)**.

The amplified transmit signal from **Q1132** is passed through diode switch **D1106 (HSC277)** and the driver amplifier **Q1134 (RD07MVS1)** to the diode switch **D1107 (HSC277)**, then finally amplified by power amplifier **Q1135 (RD70HVF1)**, providing up to 35 Watts of power output. These three stages of the power amplifier’s gain are controlled by the APC circuit.

The 35-Watt RF signal is passed through a high-pass filter network to the antenna switch **D1118, D1119**, and **D1120** (all **UM9957F**), then passed through a low-pass filter network and another high-pass filter network to the **ANT** jack.

144 MHz Signal

The adjusted speech signal from **Q1074** is passed through the transistor switch **Q1114, Q1115** (both **DTC144EE**) to varactor diodes **D1082** and **D1085** (both **HVC365**), which frequency modulate the transmitting VCO, made up of VHF-VCO/B **Q1120 (2SC5374)** and **D1083 (HVC131)**.

The modulated transmit signal is passed through buffer amplifiers **Q1121** and **Q1122** (both **2SC5374**) and diode switches **D1089** and **D1102** (both **HSC277**) to the pre-drive amplifier **Q1132 (2SK2596)**.

The amplified transmit signal from **Q1132** is passed through the diode switch **D1105, D1106** (both **HSC277**) and the driver amplifier **Q1134 (RD07MVS1)** to diode switch **D1108 (RLS135)**, then finally amplified by power amplifier **Q1135 (RD70HVF1)** up to 50 Watts of power output. These three stages of the power amplifier’s gain are controlled by the APC circuit.

The 50-Watt RF signal is passed through a low-pass filter network to the antenna switch **D1113** and **D1114** (**UM9957F**), then passed through a high-pass filter network and another low-pass filter network to the ANT jack.

APC (Automatic Power Control) Circuit

430 MHz

A portion of the power amplifier output is rectified by **D1121** and **D1122** (both **MA2S728**) then delivered to APC **Q1129** (**NJM2904V**), as a DC voltage which is proportional to the output level of the power amplifier.

At **Q1129**, the rectified DC voltage from the power amplifier is compared to the reference voltage from the main CPU **Q1104** to produce a control voltage, which regulates the supply voltage to the pre-drive amplifier **Q1132** (**2SK2596**), driver amplifier **Q1134** (**RD07MVS1**), and power amplifier **Q1135** (**RD70HVF1**), so as to maintain stable output power under varying antenna loading conditions.

144 MHz

A portion of the power amplifier output is rectified by **D1109** and **D1110** (both **MA2S728**) then delivered to APC **Q1129** (**NJM2904V**), as a DC voltage which is proportional to the output level of the power amplifier.

At **Q1129**, the rectified DC voltage from the power amplifier is compared to the reference voltage from the main CPU **Q1104** to produce a control voltage, which regulates the supply voltage to the pre-drive amplifier **Q1132** (**2SK2596**), driver amplifier **Q1134** (**RD07MVS1**), and power amplifier **Q1135** (**RD70HVF1**), so as to maintain stable output power under varying antenna loading conditions.

PTT (Push to Talk) Circuit

430 MHz

When the PTT switch is pressed, pin 8 of sub CPU **Q2001** (**M38223M4M**) goes “high,” which sends the “PTT” command to main CPU **Q1104**.

When the “PTT” command is received, the main CPU controls the I/O IC **Q1095** (**BU2090FS**), causing pin 8 of **Q1095** to go “low” which activates the UHF TX switch section of **Q1096** (**IMT17**).

When the UHF TX switch section of **Q1096** is activated, it controls the antenna switch diodes **D1118**, **D1119**, and **D1120** (all **UM9957F**), modulator switching diode **D1088** (**DAN222**), modulator switching transistor **Q1114** and **Q1115** (both **DTC144EE**), diode switches **D1099**, **D1101**, **D1106** and **D1107** (all **HSC277**), and APC switches **Q1130** (**DTA144EE**) and **Q1131** (**DTC144EE**), which activate the 430 MHz transmitter circuit.

144 MHz

When the PTT switch is pressed, pin 8 of sub CPU **Q2001** (**M38223M4M**) goes “high,” which sends the “PTT” command to main CPU **Q1104**.

When the “PTT” command is received, the main CPU controls the I/O IC **Q1095** (**BU2090FS**), causing pin 9 of **Q1095** to go “low” which activates the VHF TX switch section of **Q1096** (**IMT17**).

When the VHF TX switch section of **Q1096** is activated, it controls the antenna switch diodes **D1113** and **D1114** (both **UM9957F**), **D1117** (**HSC277**) and **D1115**, **D1116** (**RLS135**), modulator switching transistor **Q1114** and **Q1115** (both **DTC144EE**), diode switches **D1089**, **D1102**, **D1105**, **D1106** (all **HSC277**) and **D1108** (**RLS135**), and APC switches **Q1130** (**DTA144EE**) and **Q1131** (**DTC144EE**), which activate the 144 MHz transmitter circuit.

PLL Circuit

“Main” band

A portion of the output from UHF-VCO/B **Q1116** (**2SC5006**) is passed through buffer amplifier **Q1117** (**2SC5006**) and diode switch **D1086** (**HSC277**) to the programmable divider section of the PLL IC **Q1109** (**MB15A02PFV1**), where it is divided according to the frequency dividing data associated with the operating frequency input from the main CPU **Q1104**. It is then sent to the phase comparator.

A portion of the output from the VHF-VCO/B **Q1120** (**2SC5374**) is passed through buffer amplifier **Q1121** (**2SC5374**) and diode switch **D1087** (**HSC277**) to the programmable divider section of the PLL IC **Q1109**, where it is divided according to the frequency dividing data associated with the operating frequency input from the main CPU **Q1104**. It is then sent to the phase comparator.

The 11.15 MHz reference oscillator **X1002** frequency is divided by the reference frequency divider section of **Q1109** into 2230 or 1784 parts, to become 5 kHz or 6.25 kHz comparative reference frequencies, which are utilized by the phase comparator.

The phase comparator section of **Q1109** compares the phase between the frequency-divided oscillation frequency of the VCO circuit and the comparative frequency, and its output is a pulse corresponding to the phase difference. This pulse is integrated by the loop filter into a control voltage (VCV) to control the oscillation frequency of the VCOs.

Circuit Description

“Sub” band

A portion of the output from the UHF-VCO/A **Q1123 (2SC5006)** is passed through buffer amplifier **Q1124 (2SC5006)** and diode switch **D1093 (HVC131)** to the programmable divider section of the PLL IC **Q1122 (MB15A02PFV1)**, where it is divided according to the frequency dividing data associated with the operating frequency input from the main CPU **Q1104**. It is then sent to the phase comparator.

A portion of the output from the VHF-VCO/A **Q1126 (2SC5374)** is passed through buffer amplifier **Q1127 (2SC5374)** and diode switch **D1097 (HVC131)** to the programmable divider section of the PLL IC **Q1122**, where it is divided according to the frequency dividing data associated with the operating frequency input from the main CPU **Q1104**. It is then sent to the phase comparator.

The 11.7 MHz reference oscillator **X1003** frequency is divided by the reference frequency divider section of **Q1122** into 2340 or 1872 parts to become 5 kHz or 6.25 kHz comparative reference frequencies, which are utilized by the phase comparator.

The phase comparator section of **Q1122** compares the phase between the frequency-divided oscillation frequency of the VCO circuit and the comparative frequency, and its output is a pulse corresponding to the phase difference. This pulse is integrated by the loop filter into a control voltage (VCV) to control the oscillation frequency of the VCOs.

Power Supply Line

When the user presses and holds in the “Right” VOL knob for 2 seconds, pin 23 of the main CPU **Q1104** goes “low” and pin 40 of main CPU **Q1104** goes “high,” which activates the power switch **Q1078 (2SB1301)** and **Q1082 (2SC4617)**, to supply 13.8 VDC to each circuit in the transceiver.

Introduction and Precautions

The **FT-8800R** has been carefully aligned at the factory for the specified performance across the 144 MHz and 430 MHz amateur bands. Realignment should therefore not be necessary except in the event of a component failure. All component replacement and service should be performed only by an authorized Vertex Standard representative, or the warranty policy may be voided.

The following procedures cover the sometimes critical and tedious adjustments that are not normally required once the transceiver has left the factory. However, if damage occurs and some parts are replaced, realignment may be required. If a sudden problem occurs during normal operation, it is likely due to component failure; realignment should not be done until after the faulty component has been replaced.

We recommend that servicing be performed only by authorized Vertex Standard service technicians who are experienced with the circuitry and fully equipped for repair and alignment. Therefore, if a fault is suspected, contact the dealer from whom the transceiver was purchased for instructions regarding repair. Authorized Vertex Standard service technicians realign all circuits and make complete performance checks to ensure compliance with factory specifications after replacing any faulty components.

Those who do undertake any of the following alignments are cautioned to proceed at their own risk. Problems caused by unauthorized attempts at realignment are not covered by the warranty policy. Also, Vertex Standard must reserve the right to change circuits and alignment procedures in the interest of improved performance, without notifying owners.

Under no circumstances should any alignment be attempted unless the normal function and operation of the transceiver are clearly understood, the cause of the malfunction has been clearly pinpointed and any faulty components replaced, and the need for realignment determined to be absolutely necessary.

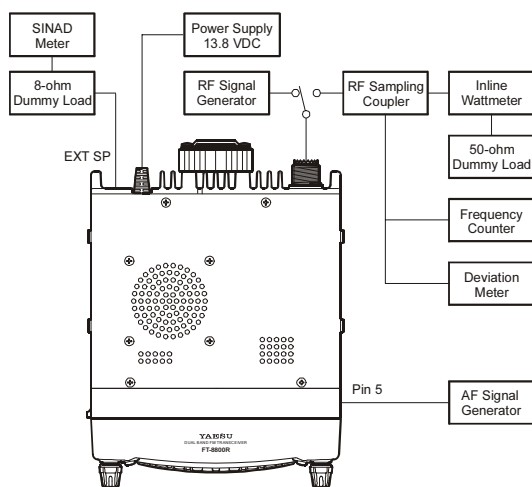

Required Test Equipment

The following test equipment (and thorough familiarity with its correct use) is necessary for complete realignment. Correction of problems caused by misalignment resulting from use of improper test equipment is not covered under the warranty policy. While most steps do not require all of the equipment listed, the interactions of some adjustments may require that more complex adjustments be performed afterwards. Do not attempt to perform only a single step unless it is clearly isolated electrically from all other steps. Have all test equipment ready before beginning, and follow all of the steps in a section in the order presented.

- Regulated DC Power Supply: adjustable from 11.5 to 16 VDC, 10 A
- RF Signal Generator with calibrated output level at 500 MHz
- Frequency Counter: ± 0.1 ppm accuracy at 500 MHz
- AF Signal Generator
- SINAD Meter
- Oscilloscope
- Spectrum Analyzer
- Deviation Meter (linear detector)
- AF Milivoltmeter
- AF Dummy Load: 8-Ohm, 5 W
- DC Voltmeter: high impedance
- Inline Wattmeter with 5% accuracy at 500 MHz
- 50-Ohm non-reactive Dummy Load: 100 watts at 500 MHz
- VHF/UHF Sampling Coupler

Set up the test equipment as shown for the transceiver alignment, and apply 13.8 VDC power to the transceiver.

Alignment Preparation & Precautions

A dummy load and inline wattmeter must be connected to the main antenna jack in all procedures that call for transmission, except where specified otherwise. Correct alignment is not possible with an antenna. After completing one step, read the following step to determine whether the same test equipment will be required. If not, remove the test equipment (except dummy load and wattmeter, if connected) before proceeding.

Correct alignment requires that the ambient temperature in the repair shop be the same as that of the transceiver and test equipment, and that this temperature be held constant between 68 °C and 86 °F (20 °C ~ 30 °C). When the transceiver is brought into the shop from hot or cold air it should be allowed some time for thermal equalization with the environment before alignment. If possible, alignments should be made with oscillator shields and circuit boards firmly affixed in place. Also, the test equipment must be thoroughly warmed up before beginning.

Notes: Signal levels in dB referred to in alignment are based on $0 \text{ dB}\mu = 0.5 \mu\text{V}$ (closed circuit).

TX Power Output

1. Press the “Sub” band **DIAL** knob momentarily, if needed, to switch the “Main” band to be the “Right” band.
2. Tune the “Right” band frequency to 440.050 MHz, then set the Transmit Power Level to “LOW.”
3. Press and hold in the in the “Left” **DIAL** knob to set the Alignment parameter to “b-2 PWR.xxH.”
4. Press the **PTT** switch to activate the transmitter, and adjust the “Left” **DIAL** knob, as needed, so that the wattmeter reading is 5 Watts (± 0.5 Watt).
5. Increase the Transmit Power Level to “MID2.”
6. Press the **PTT** switch to activate the transmitter, and adjust the “Left” **DIAL** knob, as needed, so that the wattmeter reading is 10 Watts (± 0.5 Watt).
7. Increase the Transmit Power Level to “MID1.”
8. Press the **PTT** switch to activate the transmitter, and adjust the “Left” **DIAL** knob, as needed, so that the wattmeter reading is 20 Watts (± 0.5 Watt).
9. Increase the Transmit Power Level to “HIGH.”
10. Press the **PTT** switch to activate the transmitter, and adjust the “Left” **DIAL** knob, as needed, so that the wattmeter reading is 35 Watts (± 0.5 Watt).
11. Tune the “Right” band frequency to 146.050 MHz, then set the Transmit Power Level to “LOW.”
12. Press the **PTT** switch to activate the transmitter, and adjust the “Left” **DIAL** knob, as needed, so that the wattmeter reading is 5 Watts (± 0.5 Watt).
13. Increase the Transmit Power Level to “MID2.”
14. Press the **PTT** switch to activate the transmitter, and adjust the “Left” **DIAL** knob, as needed, so that the wattmeter reading is 10 Watts (± 0.5 Watt).
15. Increase the Transmit Power Level to “MID1.”
16. Press the **PTT** switch to activate the transmitter, and adjust the “Left” **DIAL** knob, as needed, so that the wattmeter reading is 20 Watts (± 0.5 Watt).
17. Increase the Transmit Power Level to “HIGH.”
18. Press the **PTT** switch to activate the transmitter, and adjust the “Left” **DIAL** knob, as needed, so that the wattmeter reading is 50 Watts (± 0.5 Watt).

TX Deviation

1. Press the “Sub” band **DIAL** knob momentarily, if needed, to switch the “Main” band to be the “Right” band.
2. Tune the “Right” band frequency to 440.050 MHz, then set the Transmit Power Level to “LOW.”
3. Press and hold in the in the “Left” **DIAL** knob to set the Alignment parameter to “b-3 DEV.xxH.”
4. Inject a 1 kHz audio tone at a level of 80 mV from the Audio Generator.
5. Press the **PTT** switch to activate the transmitter, and adjust the “Left” **DIAL** knob, as needed, so that the deviation meter reading is 4.5 kHz (± 0.2 kHz) (USA Version: 4.2 kHz (± 0.2 kHz)).
6. Tune the “Right” band frequency to 146.050 MHz, then set the Transmit Power Level to “LOW.”
7. Press the **PTT** switch to activate the transmitter, and adjust the “Left” **DIAL** knob, as needed, so that the deviation meter reading is 4.5 kHz (± 0.2 kHz) (USA Version: 4.2 kHz (± 0.2 kHz)).

DCS Tx Deviation

1. Press the “Sub” band **DIAL** knob momentarily, if needed, to switch the “Main” band to be the “Right” band.
2. Press and hold in the in the “Left” **DIAL** knob to set the Alignment parameter to “b-4 DCS.xxH.”
3. Tune the “Right” band frequency to 440.050 MHz, then activate DCS with the 023 DCS code, and set the Transmit Power Level to “LOW.”
4. Press the **PTT** switch to activate the transmitter (with no microphone input), and adjust the “Left” **DIAL** knob, as needed, so that the deviation meter reading is between 0.60 kHz and 0.80 kHz.
5. Tune the “Right” band frequency to 146.050 MHz, then activate DCS with the 023 DCS code, and set the Transmit Power Level to “LOW.”
6. Press the **PTT** switch to activate the transmitter (with no microphone input), adjust the “Left” **DIAL** knob, as needed, so that the deviation meter reading is between 0.60 kHz and 0.80 kHz.

Alignment

CTCSS Tx Deviation

1. Press the “Sub” band **DIAL** knob momentarily, if needed, to switch the “Main” band to be the “Right” band.
2. Press and hold in the in the “Left” **DIAL** knob to set the Alignment parameter to “b-5 CTC.xxH.”
3. Tune the “Right” band frequency to 440.050 MHz, then activate the CTCSS Encoder with a 100 Hz tone, and set the Transmit Power Level to “LOW.”
4. Press the **PTT** switch to activate the transmitter (with no microphone input), and adjust the “Left” **DIAL** knob, as needed, so that the deviation meter reading is between 0.65 kHz and 0.75 kHz.
5. Tune the “Right” band frequency to 146.050 MHz, then activate the CTCSS Encoder with a 100 Hz tone, and set the Transmit Power Level to “LOW.”
6. Press the **PTT** switch to activate the transmitter (with no microphone input), and adjust the “Left” **DIAL** knob, as needed, so that the deviation meter reading is between 0.65 kHz and 0.75 kHz.

Center Meter Sensitivity

1. Inject a 440.050 MHz signal at a level of 10 dB μ from the RF Signal Generator.
2. Press the “Sub” band **DIAL** knob momentarily, if needed, to switch the “Main” band to be the “Right” band.
3. Tune the “Right” band frequency to 440.050 MHz.
4. Press and hold in the in the “Left” **DIAL** knob to set the Alignment parameter to “b-6 CTRL/V.”
5. Press the “Left” band [**LOW**] key.
6. Press the “Right” band [**SCN**] key.
7. Tune the “Left” band frequency to 440.050 MHz.
8. Press and hold in the “Right” **DIAL** knob to set the Alignment parameter to “A-6 CTRL/V.”
9. Inject a 440.050 MHz signal at a level of 10 dB μ from the RF Signal Generator.
10. Press the “Left” band [**LOW**] key.

S-Meter Sensitivity

1. Inject a 440.050 MHz signal at a level of -5 dB μ from the RF Signal Generator.
2. Press the “Sub” band **DIAL** knob momentarily, if needed, to switch the “Main” band to be the “Right” band.
3. Tune the “Right” band frequency to 440.050 MHz.
4. Press and hold in the in the “Left” **DIAL** knob to set the Alignment parameter to “b-7 SM LV.”
5. Press the “Left” band [**LOW**] key.
6. Increase the RF Signal Generator output level to +23 dB μ .
7. Press the “Left” band [**V/M**] key.
8. Tune the “Right” band frequency to 146.050 MHz.
9. Inject a 146.050 MHz signal at a level of -5 dB μ from the RF Signal Generator.

10. Press the “Left” band [**LOW**] key.
11. Increase the RF Signal Generator output level to +23 dB μ .
12. Press the “Left” band [**V/M**] key.
13. Tune the “Right” band frequency to 230.050 MHz.
14. Inject a 230.050 MHz signal at a level of -5 dB μ from the RF Signal Generator.
15. Press the “Left” band [**LOW**] key.
16. Increase the RF Signal Generator output level to +23 dB μ .
17. Press the “Left” band [**V/M**] key.
18. Tune the “Right” band frequency to 350.05 MHz.
19. Inject an 350.05 MHz signal at a level of -5 dB μ from the RF Signal Generator.
20. Press the “Left” band [**LOW**] key.
21. Increase the RF Signal Generator output level to +23 dB μ .
22. Press the “Left” band [**V/M**] key.
23. Tune the “Right” band frequency to 850.05 MHz.
24. Inject an 850.05 MHz signal at a level of +3 dB μ from the RF Signal Generator.
25. Press the “Left” band [**LOW**] key.
26. Increase the RF Signal Generator output level to +31 dB μ .
27. Press the “Left” band [**V/M**] key.
28. Press the “Right” band [**SCN**] key.
29. Tune the “Left” band frequency to 440.050 MHz.
30. Inject a 440.050 MHz signal at a level of -5 dB μ from the RF Signal Generator.
31. Press and hold in the in the “Right” **DIAL** knob to set the Alignment parameter to “a-7 SM LV.”
32. Press the “Left” band [**LOW**] key.
33. Increase the RF Signal Generator output level to +23 dB μ .
34. Press the “Left” band [**V/M**] key.
35. Tune the “Left” band frequency to 146.050 MHz.
36. Inject a 146.050 MHz signal at a level of -5 dB μ from the RF Signal Generator.
37. Press the “Left” band [**LOW**] key.
38. Increase the RF Signal Generator output level to +23 dB μ .
39. Press the “Left” band [**V/M**] key.
40. Tune the “Left” band frequency to 230.050 MHz.
41. Inject a 230.050 MHz signal at a level of -5 dB μ from the RF Signal Generator.
42. Press the “Left” band [**LOW**] key.
43. Increase the RF Signal Generator output level to +23 dB μ .
44. Press the “Left” band [**V/M**] key.
45. Tune the “Left” band frequency to 350.05 MHz.
46. Inject an 350.05 MHz signal at a level of -5 dB μ from the RF Signal Generator.
47. Press the “Left” band [**LOW**] key.
48. Increase the RF Signal Generator output level to +23 dB μ .

49. Press the “Left” band [**V/M**] key.
50. Tune the “Left” band frequency to 850.05 MHz.
51. Inject an 850.05 MHz signal at a level of +3 dB μ from the RF Signal Generator.
52. Press the “Left” band [**LOW**] key.
53. Increase the RF Signal Generator output level to +31 dB μ .
54. Press the “Left” band [**V/M**] key.

DC Voltmeter

1. Set the power supply voltage to 13.8 VDC.
2. Press and hold in the in the “Sub” band **DIAL** knob to set the Alignment parameter to “b-8 BAT SC.”
3. Press the “Left” band [**SCN**] key.

To close the Alignment mode, just press and hold in the “Right” **VOL** knob for 2 seconds (to turn the power off). The next time the transceiver is turned on, normal operation may resume.

Note:

MAIN Unit

Note:

Parts Layout



Side A

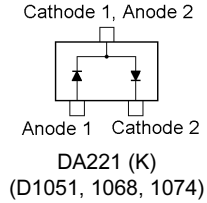
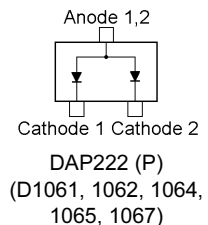
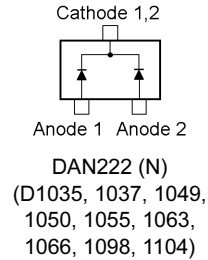
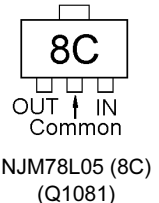
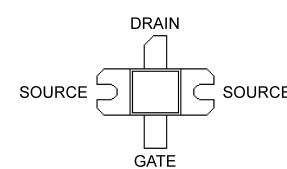
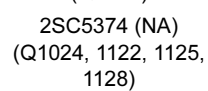
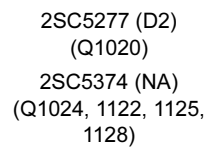
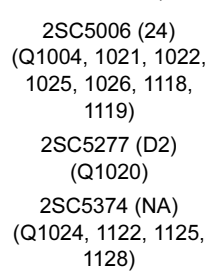
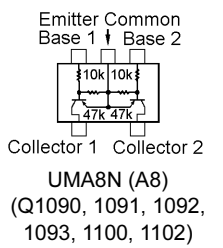
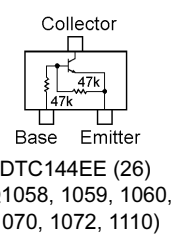
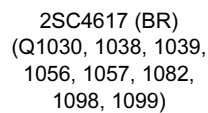
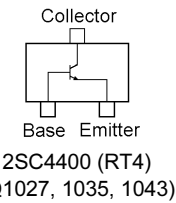
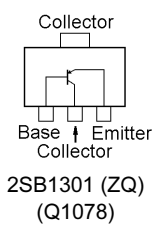
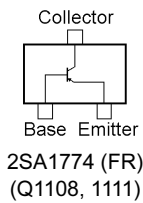
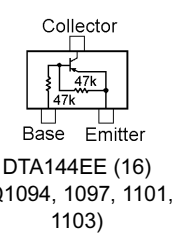
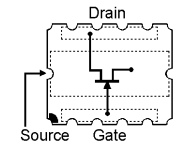
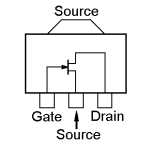
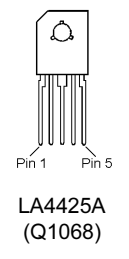
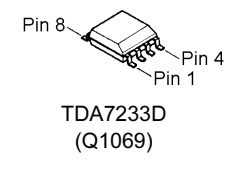
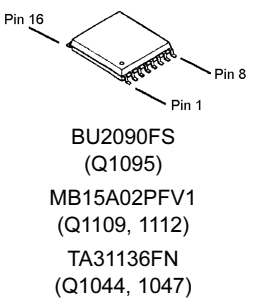
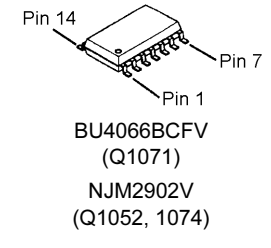
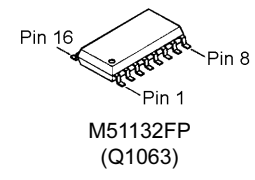
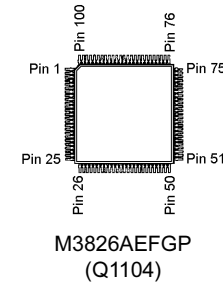



Side B

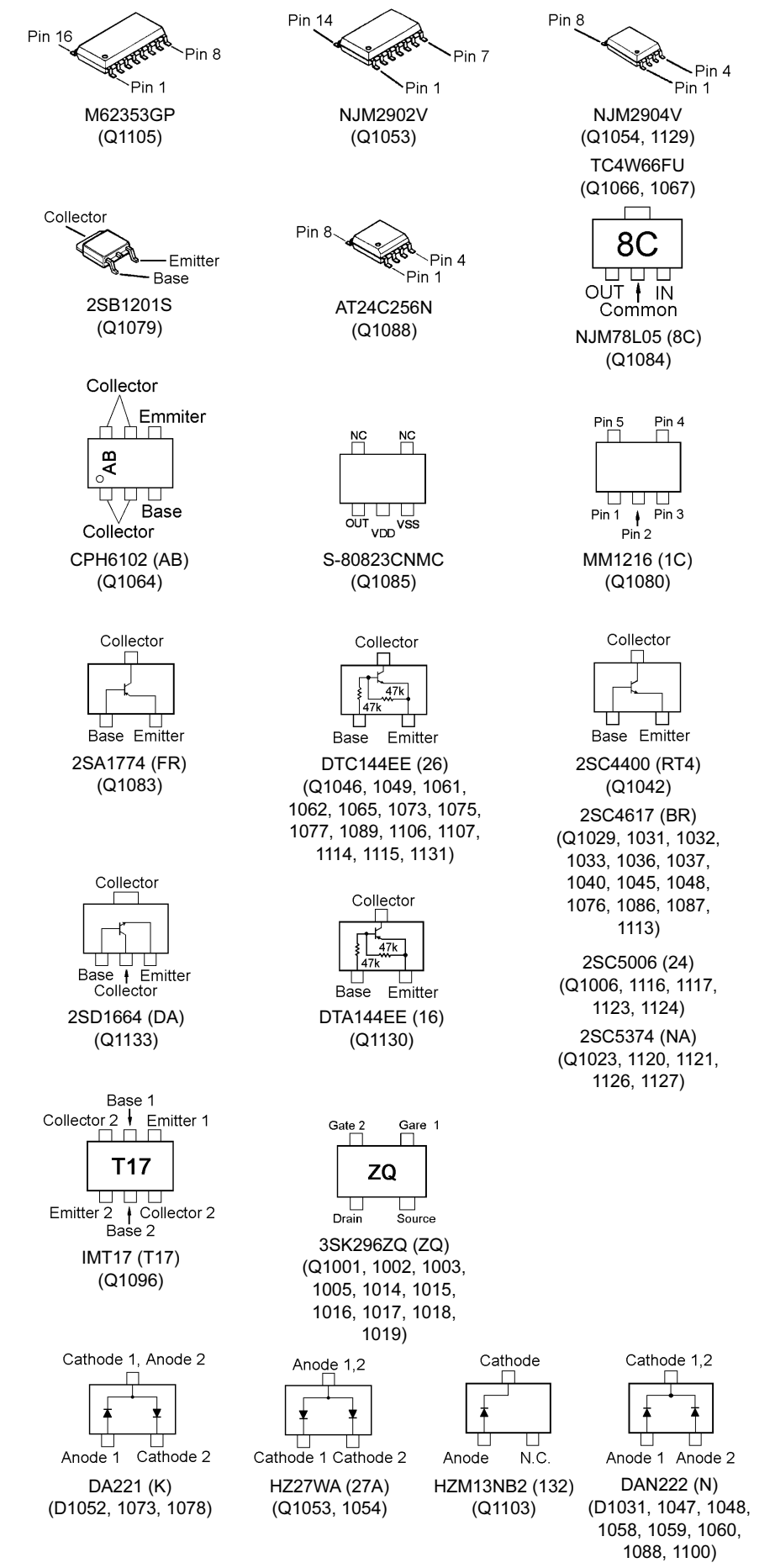

Parts List

REF	DESCRIPTION	VALUE	V/W	TOL.	MFR'S DESIG	VXSTD P/N	VERS.	LOT	SIDE	LAY ADR
PCB with Component						CS1795003	TYP: A2U			
						CS1795004	TYP: A1			
						CS1795005	TYP: A2			
						CS1795006	TYP: A3			
						CS1795007	TYP: B1			
						CS1795008	TYP: B2			
						CS1795009	TYP: B3			
						CS1795010	TYP: C1			
						CS1795011	TYP: C2			
						CS1795012	TYP: C3			
						CS1795013	TYP: D1			
						CS1795014	TYP: D2			
						CS1795015	TYP: H1			
						CS1795016	TYP: H2			
Printed Circuit Board					AH008M000	FR010190C		1-		
C 1001	CHIP CAP.	3pF	50V	CJ	GRM36CJ030B50PT	K22178290		1-	B	b3
C 1002	CHIP CAP.	33pF	50V	CH	GRM36CH330J50PT	K22178224		1-	B	b3
C 1004	CHIP CAP.	0.001uF	50V	B	GRM36B102K50PT	K22178809		1-	B	b3
C 1006	CHIP CAP.	0.001uF	50V	B	GRM36B102K50PT	K22178809		1-	B	c3
C 1007	CHIP CAP.	0.001uF	50V	B	GRM36B102K50PT	K22178809		1-	B	b3
C 1008	CHIP CAP.	0.001uF	50V	B	GRM36B102K50PT	K22178809		1-	B	b3
C 1010	CHIP CAP.	0.001uF	50V	B	GRM36B102K50PT	K22178809		1-	B	b3
C 1011	CHIP CAP.	0.001uF	50V	B	GRM36B102K50PT	K22178809		1-	B	b3
C 1012	CHIP CAP.	68pF	50V	CH	GRM36CH680J50PT	K22178232		1-	B	c3
C 1013	CHIP CAP.	0.001uF	50V	B	GRM36B102K50PT	K22178809		1-	B	c3
C 1014	CHIP CAP.	0.001uF	50V	B	GRM36B102K50PT	K22178809		1-	B	c3
C 1015	CHIP CAP.	0.5pF	50V	CK	GRM36CK0R5B50PT	K22178285		1-	B	c3
C 1016	CHIP CAP.	27pF	50V	CH	GRM36CH270J50PT	K22178222		1-	B	c3
C 1017	CHIP CAP.	2pF	50V	CK	GRM36CK020B50PT	K22178289		1-	B	c3
C 1018	CHIP CAP.	1pF	50V	CK	GRM36CK010B50PT	K22178287		1-	B	c3
C 1019	CHIP CAP.	0.5pF	50V	CK	GRM36CK0R5B50PT	K22178285		1-	B	c3
C 1020	CHIP CAP.	2pF	50V	CK	GRM36CK020B50PT	K22178289		1-	B	c3
C 1021	CHIP CAP.	27pF	50V	CH	GRM36CH270J50PT	K22178222		1-	B	c3
C 1022	CHIP CAP.	0.5pF	50V	CK	GRM36CK0R5B50PT	K22178285		1-	B	c3
C 1023	CHIP CAP.	1pF	50V	CK	GRM36CK010B50PT	K22178287		1-	B	c3
C 1024	CHIP CAP.	27pF	50V	CH	GRM36CH270J50PT	K22178222		1-	B	c3
C 1026	CHIP CAP.	15pF	50V	CH	GRM36CH150J50PT	K22178216		1-	B	c3
C 1027	CHIP CAP.	0.01uF	16V	B	GRM36B103K16PT	K22128804		1-	B	c3
C 1028	CHIP CAP.	4pF	50V	CH	GRM36CH040B50PT	K22178291		1-	A	D3
C 1029	CHIP CAP.	6pF	50V	CH	GRM36CH060B50PT	K22178293		1-	A	D3
C 1030	CHIP CAP.	0.001uF	50V	B	GRM36B102K50PT	K22178809		1-	A	E3
C 1031	CHIP CAP.	7pF	50V	CH	GRM36CH070B50PT	K22178294		1-	A	D3
C 1032	CHIP CAP.	1.5pF	50V	CK	GRM36CK1R5B50PT	K22178288		1-	A	D3
C 1033	CHIP CAP.	5pF	50V	CH	GRM36CH050B50PT	K22178292		1-	A	D3
C 1034	CHIP CAP.	22pF	50V	CH	GRM36CH220J50PT	K22178220		1-	A	D3
C 1035	CHIP CAP.	0.001uF	50V	B	GRM36B102K50PT	K22178809		1-	A	D3
C 1036	CHIP CAP.	1pF	50V	CK	GRM36CK010B50PT	K22178287		1-	A	D3
C 1037	CHIP CAP.	0.001uF	50V	B	GRM36B102K50PT	K22178809		1-	B	c3
C 1038	CHIP CAP.	2pF	50V	CK	GRM36CK020B50PT	K22178289		1-	B	c3
C 1039	CHIP CAP.	0.001uF	50V	B	GRM36B102K50PT	K22178809		1-	B	c3
C 1040	CHIP CAP.	0.001uF	50V	B	GRM36B102K50PT	K22178809		1-	B	c3
C 1041	CHIP CAP.	0.001uF	50V	B	GRM36B102K50PT	K22178809		1-	B	c3
C 1042	CHIP CAP.	0.001uF	50V	B	GRM36B102K50PT	K22178809		1-	B	b4
C 1043	CHIP CAP.	0.001uF	50V	B	GRM36B102K50PT	K22178809		1-	B	b4
C 1044	CHIP CAP.	68pF	50V	CH	GRM36CH680J50PT	K22178232		1-	B	b4
C 1045	CHIP CAP.	0.5pF	50V	CK	GRM36CK0R5B50PT	K22178285		1-	B	b4
C 1046	CHIP CAP.	27pF	50V	CH	GRM36CH270J50PT	K22178222		1-	B	b4
C 1047	CHIP CAP.	0.5pF	50V	CK	GRM36CK0R5B50PT	K22178285		1-	B	b4
C 1048	CHIP CAP.	1pF	50V	CK	GRM36CK010B50PT	K22178287		1-	B	b4
C 1049	CHIP CAP.	0.5pF	50V	CK	GRM36CK0R5B50PT	K22178285		1-	B	b4
C 1050	CHIP CAP.	27pF	50V	CH	GRM36CH270J50PT	K22178222		1-	B	b4
C 1051	CHIP CAP.	0.5pF	50V	CK	GRM36CK0R5B50PT	K22178285		1-	B	b4
C 1052	CHIP CAP.	27pF	50V	CH	GRM36CH270J50PT	K22178222		1-	B	b4
C 1054	CHIP CAP.	15pF	50V	CH	GRM36CH150J50PT	K22178216		1-	B	b5
C 1055	CHIP CAP.	0.01uF	16V	B	GRM36B103K16PT	K22128804		1-	B	b5
C 1056	CHIP CAP.	10pF	50V	CH	GRM36CH100B50PT	K22178297		1-	A	E5
C 1057	CHIP CAP.	0.001uF	50V	B	GRM36B102K50PT	K22178809		1-	B	b4
C 1058	CHIP CAP.	6pF	50V	CH	GRM36CH060B50PT	K22178293		1-	B	b4
C 1059	CHIP CAP.	1.5pF	50V	CK	GRM36CK1R5B50PT	K22178288		1-	B	b4
C 1060	CHIP CAP.	6pF	50V	CH	GRM36CH060B50PT	K22178293		1-	B	b4
C 1061	CHIP CAP.	22pF	50V	CH	GRM36CH220J50PT	K22178220		1-	B	b4
C 1062	CHIP CAP.	0.001uF	50V	B	GRM36B102K50PT	K22178809		1-	B	b5
C 1063	CHIP CAP.	1pF	50V	CK	GRM36CK010B50PT	K22178287		1-	B	b5
C 1064	CHIP CAP.	0.001uF	50V	B	GRM36B102K50PT	K22178809		1-	B	b5
C 1065	CHIP CAP.	0.001uF	50V	B	GRM36B102K50PT	K22178809		1-	B	b5
C 1066	CHIP CAP.	2pF	50V	CK	GRM36CK020B50PT	K22178289		1-	B	b5
C 1067	CHIP CAP.	0.001uF	50V	B	GRM36B102K50PT	K22178809		1-	B	b5

MAIN Unit

REF	DESCRIPTION	VALUE	V/W	TOL.	MFR'S DESIG	VXSTD P/N	VERS.	LOT	SIDE	LAY ADR
C 1068	CHIP CAP.	0.001uF	50V	B	GRM36B102K50PT	K22178809		1-	B	b4
C 1070	CHIP CAP.	30pF	50V	CH	GRM36CH300J50PT	K22178223		1-	B	b2
C 1071	CHIP CAP.	7pF	50V	CH	GRM36CH070B50PT	K22178294		1-	B	b2
C 1073	CHIP CAP.	27pF	50V	CH	GRM36CH270J50PT	K22178222		1-	B	b2
C 1074	CHIP CAP.	12pF	50V	CH	GRM36CH120J50PT	K22178214		1-	B	b2
C 1075	CHIP CAP.	1pF	50V	CK	GRM36CK010B50PT	K22178287		1-	B	b3
C 1076	CHIP CAP.	0.001uF	50V	B	GRM36B102K50PT	K22178809		1-	B	b3
C 1077	CHIP CAP.	0.001uF	50V	B	GRM36B102K50PT	K22178809		1-	B	b3
C 1078	CHIP CAP.	56pF	50V	CH	GRM36CH560J50PT	K22178230		1-	B	b3
C 1079	CHIP CAP.	0.75pF	50V	CK	GRM36CKR75B50PT	K22178286		1-	B	b3
C 1080	CHIP CAP.	0.75pF	50V	CK	GRM36CKR75B50PT	K22178286		1-	B	b3
C 1081	CHIP CAP.	0.001uF	50V	B	GRM36B102K50PT	K22178809		1-	B	b3
C 1082	CHIP CAP.	0.1uF	10V	B	GRM36B104K10PT	K22108802		1-	B	b3
C 1083	CHIP CAP.	0.001uF	50V	B	GRM36B102K50PT	K22178809		1-	B	b3
C 1086	CHIP CAP.	0.001uF	50V	B	GRM36B102K50PT	K22178809		1-	B	c4
C 1087	CHIP CAP.	0.001uF	50V	B	GRM36B102K50PT	K22178809		1-	B	b4
C 1088	CHIP CAP.	1pF	50V	CK	GRM36CK010B50PT	K22178287		1-	B	b3
C 1089	CHIP CAP.	8pF	50V	CH	GRM36CH080B50PT	K22178295		1-	B	b3
C 1090	CHIP CAP.	1pF	50V	CK	GRM36CK010B50PT	K22178287		1-	B	b4
C 1091	CHIP CAP.	47pF	50V	CH	GRM36CH470J50PT	K22178228		1-	B	b4
C 1092	CHIP CAP.	0.75pF	50V	CK	GRM36CKR75B50PT	K22178286		1-	B	c3
C 1093	CHIP CAP.	18pF	50V	CH	GRM36CH180J50PT	K22178218		1-	B	c4
C 1094	CHIP CAP.	0.75pF	50V	CK	GRM36CKR75B50PT	K22178286		1-	B	c3
C 1095	CHIP CAP.	1.5pF	50V	CK	GRM36CK1R5B50PT	K22178288		1-	B	c3
C 1096	CHIP CAP.	47pF	50V	CH	GRM36CH470J50PT	K22178228		1-	B	c4
C 1097	CHIP CAP.	8pF	50V	CH	GRM36CH080B50PT	K22178295		1-	B	c4
C 1098	CHIP CAP.	0.5pF	50V	CK	GRM36CK0R5B50PT	K22178285		1-	B	c3
C 1099	CHIP CAP.	1pF	50V	CK	GRM36CK010B50PT	K22178287		1-	B	c4
C 1100	CHIP CAP.	47pF	50V	CH	GRM36CH470J50PT	K22178228		1-	B	c4
C 1101	CHIP CAP.	10pF	50V	CH	GRM36CH100D50PT	K22178212		1-	B	c4
C 1102	CHIP CAP.	0.01uF	16V	B	GRM36B103K16PT	K22128804		1-	B	c3
C 1103	CHIP CAP.	0.001uF	50V	B	GRM36B102K50PT	K22178809		1-	B	c4
C 1104	CHIP CAP.	7pF	50V	CH	GRM36CH070B50PT	K22178294		1-	B	c3
C 1105	CHIP CAP.	0.001uF	50V	B	GRM36B102K50PT	K22178809		1-	B	c3
C 1106	CHIP CAP.	0.001uF	50V	B	GRM36B102K50PT	K22178809		1-	B	b3
C 1107	CHIP CAP.	0.001uF	50V	B	GRM36B102K50PT	K22178809		1-	B	b3
C 1108	CHIP CAP.	0.1uF	10V	B	GRM36B104K10PT	K22108802		1-	B	b3
C 1109	CHIP CAP.	1pF	50V	CK	GRM36CK010B50PT	K22178287		1-	B	b4
C 1110	CHIP CAP.	0.001uF	50V	B	GRM36B102K50PT	K22178809		1-	B	b4
C 1111	CHIP CAP.	0.001uF	50V	B	GRM36B102K50PT	K22178809		1-	B	a4
C 1112	CHIP CAP.	8pF	50V	CH	GRM36CH080B50PT	K22178295		1-	B	b4
C 1113	CHIP CAP.	1pF	50V	CK	GRM36CK010B50PT	K22178287		1-	B	b4
C 1114	CHIP CAP.	47pF	50V	CH	GRM36CH470J50PT	K22178228		1-	B	a4
C 1115	CHIP CAP.	0.75pF	50V	CK	GRM36CKR75B50PT	K22178286		1-	B	b4
C 1116	CHIP CAP.	18pF	50V	CH	GRM36CH180J50PT	K22178218		1-	B	a4
C 1117	CHIP CAP.	1.5pF	50V	CK	GRM36CK1R5B50PT	K22178288		1-	B	b4
C 1118	CHIP CAP.	0.75pF	50V	CK	GRM36CKR75B50PT	K22178286		1-	B	b4
C 1119	CHIP CAP.	47pF	50V	CH	GRM36CH470J50PT	K22178228		1-	B	a4
C 1120	CHIP CAP.	0.5pF	50V	CK	GRM36CK0R5B50PT	K22178285		1-	B	b4
C 1121	CHIP CAP.	8pF	50V	CH	GRM36CH080B50PT	K22178295		1-	B	a4
C 1122	CHIP CAP.	1pF	50V	CK	GRM36CK010B50PT	K22178287		1-	B	b4
C 1123	CHIP CAP.	47pF	50V	CH	GRM36CH470J50PT	K22178228		1-	B	a4
C 1124	CHIP CAP.	10pF	50V	CH	GRM36CH100D50PT	K22178212		1-	B	a5
C 1125	CHIP CAP.	0.01uF	16V	B	GRM36B103K16PT	K22128804		1-	B	b5
C 1126	CHIP CAP.	0.001uF	50V	B	GRM36B102K50PT	K22178809		1-	B	a5
C 1127	CHIP CAP.	7pF	50V	CH	GRM36CH070B50PT	K22178294		1-	B	b5
C 1128	CHIP CAP.	0.001uF	50V	B	GRM36B102K50PT	K22178809		1-	B	b5
C 1129	CHIP CAP.	0.001uF	50V	B	GRM36B102K50PT	K22178809		1-	B	b2
C 1131	CHIP CAP.	18pF	50V	CH	GRM36CH180J50PT	K22178218		1-	B	b2
C 1132	CHIP CAP.	7pF	50V	CH	GRM36CH070B50PT	K22178294		1-	B	b2
C 1134	CHIP CAP.	22pF	50V	CH	GRM36CH220J50PT	K22178220		1-	B	b3
C 1135	CHIP CAP.	0.001uF	50V	B	GRM36B102K50PT	K22178809		1-	B	b2
C 1136	CHIP CAP.	0.001uF	50V	B	GRM36B102K50PT	K22178809		1-	B	b3
C 1137	CHIP CAP.	0.001uF	50V	B	GRM36B102K50PT	K22178809		1-	B	b3
C 1138	CHIP CAP.	0.5pF	50V	CK	GRM36CK0R5B50PT	K22178285		1-	B	b3
C 1139	CHIP CAP.	0.001uF	50V	B	GRM36B102K50PT	K22178809		1-	B	a3
C 1140	CHIP CAP.	0.001uF	50V	B	GRM36B102K50PT	K22178809		1-	B	b3
C 1141	CHIP CAP.	0.001uF	50V	B	GRM36B102K50PT	K22178809		1-	B	b4
C 1142	CHIP CAP.	47pF	50V	CH	GRM36CH470J50PT	K22178228		1-	B	b4
C 1143	CHIP CAP.	7pF	50V	CH	GRM36CH070B50PT	K22178294		1-	B	c4
C 1144	CHIP CAP.	2pF	50V	CK	GRM36CK020B50PT	K22178289		1-	B	c4
C 1145	CHIP CAP.	5pF	50V	CH	GRM36CH050B50PT	K22178292		1-	B	c4
C 1146	CHIP CAP.	22pF	50V	CH	GRM36CH220J50PT	K22178220		1-	B	c4
C 1148	CHIP CAP.	0.001uF	50V	B	GRM36B102K50PT	K22178809		1-	A	E4
C 1149	CHIP CAP.	0.5pF	50V	CK	GRM36CK0R5B50PT	K22178285		1-	B	c4
C 1150	CHIP CAP.	0.001uF	50V	B	GRM36B102K50PT	K22178809		1-	A	F4
C 1151	CHIP CAP.	15pF	50V	CH	GRM36CH150J50PT	K22178216		1-	A	F4

REF	DESCRIPTION	VALUE	V/W	TOL.	MFR'S DESIG	VXSTD P/N	VERS.	LOT	SIDE	LAY ADR
C 1152	CHIP CAP.	7pF	50V	CH	GRM36CH070B50PT	K22178294		1-	A	F4
C 1153	CHIP CAP.	2pF	50V	CK	GRM36CK020B50PT	K22178289		1-	A	F4
C 1154	CHIP CAP.	6pF	50V	CH	GRM36CH060B50PT	K22178293		1-	A	E4
C 1155	CHIP CAP.	22pF	50V	CH	GRM36CH220J50PT	K22178220		1-	A	E4
C 1157	CHIP CAP.	0.001uF	50V	B	GRM36B102K50PT	K22178809		1-	A	F5
C 1158	CHIP CAP.	0.5pF	50V	CK	GRM36CK0R5B50PT	K22178285		1-	A	F5
C 1159	CHIP CAP.	0.001uF	50V	B	GRM36B102K50PT	K22178809		1-	A	F5
C 1162	CHIP CAP.	0.001uF	50V	B	GRM36B102K50PT	K22178809		1-	B	c4
C 1163	CHIP CAP.	0.001uF	50V	B	GRM36B102K50PT	K22178809		1-	A	D4
C 1165	CHIP CAP.	0.001uF	50V	B	GRM36B102K50PT	K22178809		1-	B	b2
C 1166	CHIP CAP.	2pF	50V	CK	GRM36CK020B50PT	K22178289		1-	B	a3
C 1167	CHIP CAP.	47pF	50V	CH	GRM36CH470J50PT	K22178228		1-	B	a3
C 1168	CHIP CAP.	1pF	50V	CK	GRM36CK010B50PT	K22178287		1-	B	a3
C 1169	CHIP CAP.	2pF	50V	CK	GRM36CK020B50PT	K22178289		1-	B	a3
C 1170	CHIP CAP.	6pF	50V	CH	GRM36CH060B50PT	K22178293		1-	B	a3
C 1171	CHIP CAP.	7pF	50V	CH	GRM36CH070B50PT	K22178294		1-	A	F3
C 1172	CHIP CAP.	5pF	50V	CH	GRM36CH050B50PT	K22178292		1-	A	F3
C 1173	CHIP CAP.	12pF	50V	CH	GRM36CH120J50PT	K22178214		1-	A	F4
C 1174	CHIP CAP.	0.001uF	50V	B	GRM36B102K50PT	K22178809		1-	A	F4
C 1175	CHIP CAP.	1.5pF	50V	CK	GRM36CK1R5B50PT	K22178288		1-	A	F3
C 1176	CHIP CAP.	1pF	50V	CK	GRM36CK010B50PT	K22178287		1-	A	F3
C 1178	CHIP CAP.	8pF	50V	CH	GRM36CH080B50PT	K22178295		1-	A	F4
C 1179	CHIP CAP.	0.001uF	50V	B	GRM36B102K50PT	K22178809		1-	A	E4
C 1181	CHIP CAP.	1pF	50V	CK	GRM36CK010B50PT	K22178287		1-	A	E4
C 1182	CHIP CAP.	1pF	50V	CK	GRM36CK010B50PT	K22178287		1-	A	E4
C 1183	CHIP CAP.	10pF	50V	CH	GRM36CH100D50PT	K22178212		1-	A	D4
C 1184	CHIP CAP.	1pF	50V	CK	GRM36CK010B50PT	K22178287		1-	A	D4
C 1185	CHIP CAP.	2pF	50V	CK	GRM36CK020B50PT	K22178289		1-	A	D4
C 1186	CHIP CAP.	4pF	50V	CH	GRM36CH040B50PT	K22178291		1-	A	D3
C 1187	CHIP CAP.	0.001uF	50V	B	GRM36B102K50PT	K22178809		1-	A	D4
C 1188	CHIP CAP.	1pF	50V	CK	GRM36CK010B50PT	K22178287		1-	A	F4
C 1190	CHIP CAP.	8pF	50V	CH	GRM36CH080B50PT	K22178295		1-	A	F4
C 1191	CHIP CAP.	0.001uF	50V	B	GRM36B102K50PT	K22178809		1-	A	E4
C 1193	CHIP CAP.	1pF	50V	CK	GRM36CK010B50PT	K22178287		1-	A	E4
C 1194	CHIP CAP.	0.75pF	50V	CK	GRM36CKR75B50PT	K22178286		1-	A	E4
C 1195	CHIP CAP.	10pF	50V	CH	GRM36CH100B50PT	K22178297		1-	A	E4
C 1196	CHIP CAP.	0.5pF	50V	CK	GRM36CK0R5B50PT	K22178285		1-	A	E4
C 1198	CHIP CAP.	0.001uF	50V	B	GRM36B102K50PT	K22178809		1-	A	E4
C 1199	CHIP CAP.	6pF	50V	CH	GRM36CH060B50PT	K22178293		1-	A	E4
C 1200	CHIP CAP.	0.001uF	50V	B	GRM36B102K50PT	K22178809		1-	A	E4
C 1201	CHIP CAP.	0.001uF	50V	B	GRM36B102K50PT	K22178809		1-	B	e4
C 1202	CHIP CAP.	0.022uF	16V	B	GRM36B223K16PT	K22128806		1-	B	e4
C 1203	CHIP CAP.	10pF	50V	CH	GRM36CH100B50PT	K22178297		1-	B	d4
C 1204	CHIP CAP.	6pF	50V	CH	GRM36CH060B50PT	K22178293		1-	A	C4
C 1205	CHIP CAP.	0.001uF	50V	B	GRM36B102K50PT	K22178809		1-	A	C4
C 1206	CHIP CAP.	0.01uF	16V	B	GRM36B103K16PT	K22128804		1-	A	C4
C 1207	CHIP CAP.	0.01uF	16V	B	GRM36B103K16PT	K22128804		1-	A	B4
C 1208	CHIP CAP.	0.001uF	50V	B	GRM36B102K50PT	K22178809		1-	A	C4
C 1209	CHIP CAP.	0.001uF	50V	B	GRM36B102K50PT	K22178809		1-	A	E4
C 1210	CHIP CAP.	0.1uF	10V	B	GRM36B104K10PT	K22108802		1-	B	f4
C 1211	CHIP CAP.	0.01uF	16V	B	GRM36B103K16PT	K22128804		1-	A	B4
C 1212	CHIP CAP.	0.1uF	10V	B	GRM36B104K10PT	K22108802		1-	A	B4
C 1213	CHIP CAP.	0.1uF	10V	B	GRM36B104K10PT	K22108802		1-	A	B4
C 1214	CHIP CAP.	0.001uF	50V	B	GRM36B102K50PT	K22178809		1-	B	f3
C 1215	CHIP CAP.	0.01uF	16V	B	GRM36B103K16PT	K22128804		1-	B	f4
C 1216	CHIP CAP.	0.01uF	16V	B	GRM36B103K16PT	K22128804		1-	B	f3
C 1217	CHIP CAP.	0.001uF	50V	B	GRM36B102K50PT	K22178809		1-	B	f3
C 1218	CHIP CAP.	0.01uF	16V	B	GRM36B103K16PT	K22128804		1-	B	e3
C 1219	CHIP CAP.	0.001uF	50V	B	GRM36B102K50PT	K22178809		1-	B	e3
C 1220	CHIP CAP.	0.001uF	50V	B	GRM36B102K50PT	K22178809		1-	A	E5
C 1221	CHIP CAP.	0.022uF	16V	B	GRM36B223K16PT	K22128806		1-	A	E5
C 1222	CHIP CAP.	12pF	50V	CH	GRM36CH120J50PT	K22178214		1-	A	E5
C 1223	CHIP CAP.	6pF	50V	CH	GRM36CH060B50PT	K22178293		1-	A	E5
C 1224	CHIP CAP.	0.001uF	50V	B	GRM36B102K50PT	K22178809		1-	A	E5
C 1225	CHIP CAP.	0.01uF	16V	B	GRM36B103K16PT	K22128804		1-	A	E5
C 1226	CHIP CAP.	0.01uF	16V	B	GRM36B103K16PT	K22128804		1-	A	D5
C 1227	CHIP CAP.	0.001uF	50V	B	GRM36B102K50PT	K22178809		1-	A	D5
C 1228	CHIP CAP.	0.001uF	50V	B	GRM36B102K50PT	K22178809		1-	B	a4
C 1229	CHIP CAP.	0.1uF	10V	B	GRM36B104K10PT	K22108802		1-	B	d5
C 1230	CHIP CAP.	0.01uF	16V	B	GRM36B103K16PT	K22128804		1-	B	d5
C 1231	CHIP CAP.	0.1uF	10V	B	GRM36B104K10PT	K22108802		1-	B	d5
C 1232	CHIP CAP.	0.1uF	10V	B	GRM36B104K10PT	K22108802		1-	B	d5
C 1233	CHIP CAP.	0.001uF	50V	B	GRM36B102K50PT	K22178809		1-	B	d5
C 1234	CHIP CAP.	0.01uF	16V	B	GRM36B103K16PT	K22128804		1-	A	C5
C 1235	CHIP CAP.	0.01uF	16V	B	GRM36B103K16PT	K22128804		1-	A	C5
C 1236	CHIP CAP.	0.001uF	50V	B	GRM36B102K50PT	K22178809		1-	A	C5
C 1237	CHIP CAP.	0.01uF	16V	B	GRM36B103K16PT	K22128804		1-	A	C5

MAIN Unit

REF	DESCRIPTION	VALUE	V/W	TOL.	MFR'S DESIG	VXSTD P/N	VERS.	LOT	SIDE	LAY ADR
C 1238	CHIP CAP.	0.001uF	50V	B	GRM36B102K50PT	K22178809		1-	B	d5
C 1239	CHIP CAP.	0.01uF	16V	B	GRM36B103K16PT	K22128804		1-	B	e4
C 1240	CHIP CAP.	27pF	50V	CH	GRM36CH270J50PT	K22178222		1-	B	e4
C 1241	CHIP CAP.	47pF	50V	CH	GRM36CH470J50PT	K22178228		1-	B	e4
C 1242	CHIP CAP.	0.001uF	50V	B	GRM36B102K50PT	K22178809		1-	B	e4
C 1243	CHIP CAP.	1pF	50V	CK	GRM36CK010B50PT	K22178287		1-	B	d4
C 1244	CHIP CAP.	0.01uF	16V	B	GRM36B103K16PT	K22128804		1-	A	D5
C 1245	CHIP CAP.	100pF	50V	CH	GRM36CH101J50PT	K22178236		1-	A	D5
C 1246	CHIP CAP.	24pF	50V	CH	GRM36CH240J50PT	K22178221		1-	A	D5
C 1247	CHIP CAP.	0.001uF	50V	B	GRM36B102K50PT	K22178809		1-	B	c4
C 1248	CHIP CAP.	0.001uF	50V	B	GRM36B102K50PT	K22178809		1-	B	a5
C 1249	CHIP CAP.	1uF	10V	F	GRM39F105Z10PT	K22105001		1-	A	C5
C 1250	CHIP CAP.	22pF	50V	CH	GRM36CH220J50PT	K22178220		1-	A	B4
C 1251	CHIP CAP.	0.1uF	10V	B	GRM36B104K10PT	K22108802		1-	A	B4
C 1252	CHIP CAP.	56pF	50V	CH	GRM36CH560J50PT	K22178230		1-	A	B4
C 1253	CHIP CAP.	56pF	50V	CH	GRM36CH560J50PT	K22178230		1-	B	e4
C 1254	CHIP CAP.	0.01uF	16V	B	GRM36B103K16PT	K22128804		1-	A	B4
C 1255	CHIP CAP.	0.01uF	16V	B	GRM36B103K16PT	K22128804		1-	A	B5
C 1256	CHIP CAP.	0.1uF	10V	B	GRM36B104K10PT	K22108802		1-	B	e3
C 1257	CHIP CAP.	0.1uF	10V	B	GRM36B104K10PT	K22108802		1-	B	f4
C 1258	CHIP CAP.	0.1uF	10V	B	GRM36B104K10PT	K22108802		1-	B	f4
C 1259	CHIP CAP.	0.001uF	50V	B	GRM36B102K50PT	K22178809		1-	A	B4
C 1260	CHIP CAP.	0.001uF	50V	B	GRM36B102K50PT	K22178809		1-	B	e4
C 1261	CHIP CAP.	0.047uF	10V	B	GRM36B473K10PT	K22108801		1-	A	B5
C 1262	CHIP CAP.	220pF	25V	CH	GRM36CH221J25PT	K22148203		1-	B	e4
C 1263	CHIP CAP.	470pF	50V	B	GRM36B471K50PT	K22178805		1-	B	e4
C 1264	CHIP CAP.	470pF	50V	B	GRM36B471K50PT	K22178805		1-	B	e4
C 1265	CHIP CAP.	0.1uF	10V	B	GRM36B104K10PT	K22108802		1-	A	B4
C 1266	CHIP CAP.	0.01uF	16V	B	GRM36B103K16PT	K22128804		1-	B	e3
C 1267	CHIP CAP.	0.01uF	16V	B	GRM36B103K16PT	K22128804		1-	B	e4
C 1268	CHIP CAP.	100pF	50V	CH	GRM36CH101J50PT	K22178236		1-	B	e4
C 1269	CHIP TA.CAP.	22uF	6.3V		TEMSVA0J226M-8R	K78080047		1-	B	e4
C 1270	CHIP CAP.	0.01uF	16V	B	GRM36B103K16PT	K22128804		1-	B	e3
C 1271	CHIP CAP.	0.01uF	16V	B	GRM36B103K16PT	K22128804		1-	B	e3
C 1272	CHIP CAP.	20pF	50V	CH	GRM36CH200J50PT	K22178219		1-	A	D5
C 1273	CHIP CAP.	0.1uF	10V	B	GRM36B104K10PT	K22108802		1-	A	D5
C 1274	CHIP CAP.	56pF	50V	CH	GRM36CH560J50PT	K22178230		1-	A	D5
C 1275	CHIP CAP.	56pF	50V	CH	GRM36CH560J50PT	K22178230		1-	B	d5
C 1276	CHIP CAP.	0.01uF	16V	B	GRM36B103K16PT	K22128804		1-	A	D5
C 1277	CHIP CAP.	0.01uF	16V	B	GRM36B103K16PT	K22128804		1-	A	B5
C 1278	CHIP CAP.	0.1uF	10V	B	GRM36B104K10PT	K22108802		1-	B	d5
C 1279	CHIP CAP.	0.001uF	50V	B	GRM36B102K50PT	K22178809		1-	A	C5
C 1280	CHIP CAP.	0.001uF	50V	B	GRM36B102K50PT	K22178809		1-	B	d5
C 1281	CHIP CAP.	0.047uF	10V	B	GRM36B473K10PT	K22108801		1-	A	B5
C 1282	CHIP CAP.	220pF	25V	CH	GRM36CH221J25PT	K22148203		1-	B	d5
C 1283	CHIP CAP.	470pF	50V	B	GRM36B471K50PT	K22178805		1-	B	d5
C 1284	CHIP CAP.	470pF	50V	B	GRM36B471K50PT	K22178805		1-	B	d5
C 1285	CHIP CAP.	0.1uF	10V	B	GRM36B104K10PT	K22108802		1-	A	D5
C 1286	CHIP CAP.	0.01uF	16V	B	GRM36B103K16PT	K22128804		1-	B	d5
C 1287	CHIP CAP.	0.01uF	16V	B	GRM36B103K16PT	K22128804		1-	B	c5
C 1288	CHIP TA.CAP.	22uF	6.3V		TEMSVA0J226M-8R	K78080047		1-	B	d5
C 1289	CHIP CAP.	0.01uF	16V	B	GRM36B103K16PT	K22128804		1-	B	d5
C 1290	CHIP CAP.	0.01uF	16V	B	GRM36B103K16PT	K22128804		1-	B	d5
C 1291	CHIP CAP.	0.1uF	10V	B	GRM36B104K10PT	K22108802		1-	B	f4
C 1292	CHIP CAP.	0.0022uF	50V	B	GRM36B222K50PT	K22178813		1-	A	A4
C 1294	CHIP CAP.	150pF	50V	CH	GRM36CH151J50PT	K22178240		1-	A	A4
C 1295	CHIP CAP.	1uF	10V	F	GRM39F105Z10PT	K22105001		1-	B	f4
C 1297	CHIP CAP.	0.0047uF	25V	B	GRM36B472K25PT	K22148830		1-	B	f4
C 1298	CHIP CAP.	0.0047uF	25V	B	GRM36B472K25PT	K22148830		1-	B	f4
C 1299	CHIP CAP.	0.0047uF	25V	B	GRM36B472K25PT	K22148830		1-	B	f4
C 1300	CHIP CAP.	0.001uF	50V	B	GRM36B102K50PT	K22178809		1-	B	f4
C 1301	CHIP CAP.	0.1uF	10V	B	GRM36B104K10PT	K22108802		1-	B	f4
C 1302	CHIP CAP.	0.1uF	10V	B	GRM36B104K10PT	K22108802		1-	B	f4
C 1303	CHIP CAP.	0.1uF	10V	B	GRM36B104K10PT	K22108802		1-	B	f4
C 1304	CHIP CAP.	0.0022uF	50V	B	GRM36B222K50PT	K22178813		1-	B	f4
C 1306	CHIP CAP.	150pF	50V	CH	GRM36CH151J50PT	K22178240		1-	B	f4
C 1307	CHIP CAP.	1uF	10V	F	GRM39F105Z10PT	K22105001		1-	B	f4
C 1308	CHIP CAP.	0.0047uF	25V	B	GRM36B472K25PT	K22148830		1-	B	f4
C 1309	CHIP CAP.	0.0047uF	25V	B	GRM36B472K25PT	K22148830		1-	B	f4
C 1310	CHIP CAP.	0.0047uF	25V	B	GRM36B472K25PT	K22148830		1-	B	f4
C 1311	CHIP CAP.	1uF	10V	F	GRM39F105Z10PT	K22105001		1-	A	B3
C 1312	CHIP CAP.	1uF	10V	F	GRM39F105Z10PT	K22105001		1-	A	B4
C 1313	CHIP CAP.	100pF	50V	CH	GRM36CH101J50PT	K22178236		1-	A	B3
C 1314	CHIP CAP.	0.1uF	10V	B	GRM36B104K10PT	K22108802		1-	A	A3
C 1315	CHIP CAP.	0.1uF	10V	B	GRM36B104K10PT	K22108802		1-	A	B3
C 1316	CHIP CAP.	1uF	10V	F	GRM39F105Z10PT	K22105001		1-	A	A1
C 1317	CHIP CAP.	0.022uF	16V	B	GRM36B223K16PT	K22128806		1-	A	A3

REF	DESCRIPTION	VALUE	V/W	TOL.	MFR'S DESIG	VXSTD P/N	VERS.	LOT	SIDE	LAY ADR
C 1318	CHIP CAP.	0.022uF	16V	B	GRM36B223K16PT	K22128806		1-	A	A3
C 1319	CHIP CAP.	0.022uF	16V	B	GRM36B223K16PT	K22128806		1-	A	A4
C 1320	CHIP CAP.	0.01uF	16V	B	GRM36B103K16PT	K22128804		1-	A	A4
C 1321	CHIP CAP.	0.0047uF	25V	B	GRM36B472K25PT	K22148830		1-	A	A4
C 1322	CHIP CAP.	680pF	50V	B	GRM36B681K50PT	K22178807		1-	A	A4
C 1323	CHIP CAP.	0.001uF	50V	B	GRM36B102K50PT	K22178809		1-	A	A4
C 1324	CHIP CAP.	0.022uF	16V	B	GRM36B223K16PT	K22128806		1-	A	A4
C 1325	CHIP CAP.	0.0068uF	25V	B	GRM36B682J25PT	K22148803		1-	A	A4
C 1326	CHIP CAP.	330pF	50V	B	GRM36B331K50PT	K22178803		1-	A	A4
C 1327	CHIP CAP.	0.47uF	25V	B	GRM40B474K25PT	K22140824		1-	A	A4
C 1328	CHIP CAP.	0.0047uF	25V	B	GRM36B472K25PT	K22148830		1-	A	A4
C 1329	CHIP CAP.	0.022uF	16V	B	GRM36B223K16PT	K22128806		1-	B	f4
C 1330	CHIP CAP.	0.01uF	16V	B	GRM36B103K16PT	K22128804		1-	B	g4
C 1331	CHIP CAP.	0.0047uF	25V	B	GRM36B472K25PT	K22148830		1-	B	g4
C 1332	CHIP CAP.	680pF	50V	B	GRM36B681K50PT	K22178807		1-	B	g4
C 1333	CHIP CAP.	0.001uF	50V	B	GRM36B102K50PT	K22178809		1-	B	g4
C 1334	CHIP CAP.	0.022uF	16V	B	GRM36B223K16PT	K22128806		1-	B	g5
C 1335	CHIP CAP.	0.0068uF	25V	B	GRM36B682J25PT	K22148803		1-	B	g5
C 1336	CHIP CAP.	330pF	50V	B	GRM36B331K50PT	K22178803		1-	B	g5
C 1337	CHIP CAP.	0.47uF	25V	B	GRM40B474K25PT	K22140824		1-	B	g5
C 1338	CHIP CAP.	0.0047uF	25V	B	GRM36B472K25PT	K22148830		1-	B	f5
C 1339	CHIP CAP.	0.1uF	10V	B	GRM36B104K10PT	K22108802		1-	A	A3
C 1340	CHIP CAP.	1uF	10V	F	GRM39F105Z10PT	K22105001		1-	A	A2
C 1341	CHIP CAP.	0.1uF	10V	B	GRM36B104K10PT	K22108802		1-	A	A3
C 1342	CHIP CAP.	1uF	10V	F	GRM39F105Z10PT	K22105001		1-	A	A2
C 1343	CHIP CAP.	0.001uF	50V	B	GRM36B102K50PT	K22178809		1-	A	A2
C 1344	CHIP TA.CAP.	10uF	10V		TEMSVA1A106M-8R	K78100028		1-	A	A2
C 1345	CHIP TA.CAP.	10uF	10V		TEMSVA1A106M-8R	K78100028		1-	A	B2
C 1346	CHIP CAP.	0.047uF	10V	B	GRM36B473K10PT	K22108801		1-	A	B2
C 1347	CHIP CAP.	0.047uF	10V	B	GRM36B473K10PT	K22108801		1-	A	B2
C 1348	CHIP CAP.	0.001uF	50V	B	GRM36B102K50PT	K22178809		1-	A	A2
C 1350	AL.ELECTRO.CAP.	100uF	16V		16V101M6X7TR2	K46120007		1-	A	A2
C 1353	AL.ELECTRO.CAP.	220uF	16V		RE2-16V221M 220UF	K40129048		1-	A	A2
C 1354	CHIP CAP.	0.001uF	50V	B	GRM36B102K50PT	K22178809		1-	B	g2
C 1355	CHIP CAP.	0.1uF	16V	B	GRM39B104K16PT	K22124805		1-	B	f2
C 1356	CHIP CAP.	0.1uF	10V	B	GRM36B104K10PT	K22108802		1-	B	f2
C 1357	CHIP CAP.	47pF	50V	CH	GRM36CH470J50PT	K22178228		1-	B	f2
C 1358	CHIP CAP.	47pF	50V	CH	GRM36CH470J50PT	K22178228		1-	B	f2
C 1359	CHIP CAP.	47pF	50V	CH	GRM36CH470J50PT	K22178228		1-	B	f3
C 1360	CHIP CAP.	47pF	50V	CH	GRM36CH470J50PT	K22178228		1-	B	f3
C 1361	CHIP TA.CAP.	22uF	6.3V		TEMSVA0J226M-8R	K78080047		1-	B	f2
C 1362	CHIP CAP.	0.001uF	50V	B	GRM36B102K50PT	K22178809		1-	B	f2
C 1363	CHIP CAP.	0.001uF	50V	B	GRM36B102K50PT	K22178809		1-	B	f3
C 1364	CHIP CAP.	0.1uF	10V	B	GRM36B104K10PT	K22108802		1-	B	f3
C 1365	CHIP CAP.	0.001uF	50V	B	GRM36B102K50PT	K22178809		1-	B	f3
C 1366	CHIP TA.CAP.	10uF	10V		TEMSVA1A106M-8R	K78100028		1-	B	f3
C 1367	CHIP TA.CAP.	10uF	10V		TEMSVA1A106M-8R	K78100028		1-	B	f3
C 1368	CHIP CAP.	0.001uF	50V	B	GRM36B102K50PT	K22178809		1-	B	f3
C 1369	AL.ELECTRO.CAP.	470uF	10V		SMG10VB470M 470UF	K40109040		1-	A	A3
C 1370	AL.ELECTRO.CAP.	470uF	16V		RE3-16V471M 470UF	K40129066		1-	A	A3
C 1372	CHIP CAP.	0.1uF	16V	B	GRM39B104K16PT	K22124805		1-	B	f3
C 1373	CHIP CAP.	1uF	10V	F	GRM39F105Z10PT	K22105001		1-	A	B1
C 1374	CHIP CAP.	0.01uF	16V	B	GRM36B103K16PT	K22128804		1-	B	f5
C 1375	CHIP CAP.	0.0015uF	50V	B	GRM36B152K50PT	K22178811		1-	A	B4
C 1376	CHIP CAP.	0.01uF	16V	B	GRM36B103K16PT	K22128804		1-	A	A4
C 1377	CHIP CAP.	0.015uF	16V	B	GRM36B153K16PT	K22128807		1-	A	B4
C 1378	CHIP CAP.	1uF	10V	F	GRM39F105Z10PT	K22105001		1-	A	A1
C 1379	CHIP CAP.	0.001uF	50V	B	GRM36B102K50PT	K22178809		1-	B	e1
C 1380	AL.ELECTRO.CAP.	10uF	16V		16V100M4X7TR2	K46120004		1-	A	B1
C 1381	CHIP CAP.	0.01uF	16V	B	GRM36B103K16PT	K22128804		1-	B	e1
C 1383	CHIP CAP.	1uF	10V	F	GRM39F105Z10PT	K22105001		1-	B	f4
C 1384	CHIP CAP.	1uF	10V	F	GRM39F105Z10PT	K22105001		1-	A	A4
C 1385	CHIP CAP.	22pF	50V	CH	GRM36CH220J50PT	K22178220		1-	A	A4
C 1386	CHIP CAP.	0.1uF	10V	B	GRM36B104K10PT	K22108802		1-	A	B4
C 1387	CHIP CAP.	1uF	10V	F	GRM39F105Z10PT	K22105001		1-	B	e5
C 1388	CHIP CAP.	47pF	50V	CH	GRM36CH470J50PT	K22178228		1-	B	e5
C 1389	CHIP CAP.	47pF	50V	CH	GRM36CH470J50PT	K22178228		1-	B	e5
C 1390	CHIP CAP.	47pF	50V	CH	GRM36CH470J50PT	K22178228		1-	B	e5
C 1391	CHIP CAP.	47pF	50V	CH	GRM36CH470J50PT	K22178228		1-	B	e5
C 1392	CHIP CAP.	47pF	50V	CH	GRM36CH470J50PT	K22178228		1-	A	B5
C 1393	AL.ELECTRO.CAP.	100uF	16V		16V101M6X7TR2	K46120007		1-	A	B2
C 1394	CHIP CAP.	0.001uF	50V	B	GRM36B102K50PT	K22178809		1-	B	e1
C 1395	CHIP TA.CAP.	22uF	16V		TEMSVB21C226M-8R	K78120028		1-	B	e2
C 1396	CHIP CAP.	0.001uF	50V	B	GRM36B102K50PT	K22178809		1-	B	e2
C 1400	CHIP TA.CAP.	10uF	10V		TEMSVA1A106M-8R	K78100028		1-	A	B2
C 1401	CHIP CAP.	0.001uF	50V	B	GRM36B102K50PT	K22178809		1-	A	B2
C 1402	CHIP CAP.	0.022uF	25V	B	GRM39B223K25PT	K22144807		1-	B	e2

MAIN Unit

REF	DESCRIPTION	VALUE	V/W	TOL.	MFR'S DESIG	VXSTD P/N	VERS.	LOT	SIDE	LAY ADR
C 1403	CHIP CAP.	0.022uF	25V	B	GRM39B223K25PT	K22144807		1-	A	A2
C 1404	AL.ELECTRO.CAP.	2200uF	16V		RE3-16V222M 2200UF	K40129064		1-	B	f1
C 1405	CHIP CAP.	0.47uF	25V	B	GRM40B474K25PT	K22140824		1-	A	B1
C 1406	CHIP CAP.	100pF	50V	CH	GRM36CH101J50PT	K22178236		1-	A	B1
C 1407	CHIP CAP.	0.1uF	10V	B	GRM36B104K10PT	K22108802		1-	B	f1
C 1408	CHIP CAP.	0.001uF	50V	B	GRM36B102K50PT	K22178809		1-	B	f3
C 1409	CHIP TA.CAP.	10uF	10V		TEMSVA1A106M-8R	K78100028		1-	B	f3
C 1410	CHIP CAP.	0.001uF	50V	B	GRM36B102K50PT	K22178809		1-	B	g4
C 1411	CHIP CAP.	0.001uF	50V	B	GRM36B102K50PT	K22178809		1-	B	g4
C 1412	CHIP CAP.	0.1uF	10V	B	GRM36B104K10PT	K22108802		1-	B	f3
C 1413	CHIP CAP.	0.01uF	16V	B	GRM36B103K16PT	K22128804		1-	B	g3
C 1414	CHIP CAP.	0.01uF	16V	B	GRM36B103K16PT	K22128804		1-	B	f3
C 1415	AL.ELECTRO.CAP.	100uF	16V		16V101M6X7TR2	K46120007		1-	A	A3
C 1416	CHIP CAP.	0.1uF	10V	B	GRM36B104K10PT	K22108802		1-	B	g4
C 1417	CHIP CAP.	22pF	50V	CH	GRM36CH220J50PT	K22178220		1-	B	f5
C 1418	CHIP CAP.	3pF	50V	CJ	GRM36CJ030B50PT	K22178290		1-	B	f5
C 1419	CHIP CAP.	10pF	50V	CH	GRM36CH100D50PT	K22178212		1-	B	f5
C 1420	CHIP CAP.	0.001uF	50V	B	GRM36B102K50PT	K22178809		1-	B	f5
C 1421	CHIP CAP.	22pF	50V	CH	GRM36CH220J50PT	K22178220		1-	A	A4
C 1422	CHIP CAP.	0.1uF	10V	B	GRM36B104K10PT	K22108802		1-	A	A4
C 1423	CHIP CAP.	0.001uF	50V	B	GRM36B102K50PT	K22178809		1-	A	A4
C 1424	CHIP CAP.	0.001uF	50V	B	GRM36B102K50PT	K22178809		1-	A	A4
C 1425	CHIP CAP.	39pF	50V	CH	GRM36CH390J50PT	K22178226		1-	A	A4
C 1426	CHIP CAP.	0.001uF	50V	B	GRM36B102K50PT	K22178809		1-	A	A4
C 1427	CHIP CAP.	0.1uF	10V	B	GRM36B104K10PT	K22108802		1-	A	A4
C 1428	CHIP CAP.	0.0047uF	25V	B	GRM36B472K25PT	K22148830		1-	B	f5
C 1429	CHIP CAP.	0.001uF	50V	B	GRM36B102K50PT	K22178809		1-	A	B4
C 1430	CHIP CAP.	100pF	50V	CH	GRM36CH101J50PT	K22178236		1-	A	A4
C 1431	CHIP CAP.	1uF	10V	F	GRM39F105Z10PT	K22105001		1-	A	B4
C 1433	CHIP TA.CAP.	10uF	10V		TEMSVA1A106M-8R	K78100028		1-	A	F5
C 1434	CHIP TA.CAP.	10uF	10V		TEMSVA1A106M-8R	K78100028		1-	A	D4
C 1436	CHIP TA.CAP.	10uF	10V		TEMSVA1A106M-8R	K78100028		1-	A	F5
C 1438	CHIP TA.CAP.	10uF	10V		TEMSVA1A106M-8R	K78100028		1-	A	D4
C 1439	CHIP CAP.	0.001uF	50V	B	GRM36B102K50PT	K22178809		1-	B	a5
C 1440	CHIP CAP.	0.001uF	50V	B	GRM36B102K50PT	K22178809		1-	B	f5
C 1441	CHIP TA.CAP.	10uF	10V		TEMSVA1A106M-8R	K78100028		1-	B	f5
C 1442	CHIP CAP.	0.001uF	50V	B	GRM36B102K50PT	K22178809		1-	B	f5
C 1443	CHIP CAP.	0.001uF	50V	B	GRM36B102K50PT	K22178809		1-	A	B3
C 1445	CHIP CAP.	39pF	50V	CH	GRM36CH390J50PT	K22178226		1-	A	D5
C 1446	CHIP CAP.	0.001uF	50V	B	GRM36B102K50PT	K22178809		1-	A	D5
C 1447	CHIP CAP.	0.75pF	50V	CK	GRM36CKR75B50PT	K22178286		1-	A	D5
C 1448	CHIP CAP.	0.022uF	16V	B	GRM36B223K16PT	K22128806		1-	B	f5
C 1449	CHIP CAP.	1uF	10V	B	GRM40B105K10PT(0.85)	K22100803		1-	B	e5
C 1450	CHIP CAP.	33pF	50V	CH	GRM36CH330J50PT	K22178224		1-	A	C4
C 1451	CHIP CAP.	0.01uF	16V	B	GRM36B103K16PT	K22128804		1-	B	e4
C 1452	CHIP CAP.	33pF	50V	CH	GRM36CH330J50PT	K22178224		1-	A	C5
C 1453	CHIP CAP.	33pF	50V	CH	GRM36CH330J50PT	K22178224		1-	A	C5
C 1454	CHIP CAP.	47pF	50V	UJ	GRP1553U1H470JZ01E	K22178319		1-	B	d4
C 1455	CHIP CAP.	6pF	50V	UJ	GRP1553U1H6R0DZ01E	K22178307		1-	B	d4
C 1456	CHIP CAP.	0.01uF	16V	B	GRM36B103K16PT	K22128804		1-	A	C4
C 1457	CHIP CAP.	0.047uF	10V	B	GRM36B473K10PT	K22108801		1-	A	C4
C 1458	CHIP TA.CAP.	10uF	10V		TEMSVA1A106M-8R	K78100028		1-	A	C4
C 1459	CHIP CAP.	0.001uF	50V	B	GRM39B102K50PT	K22174821		1-	A	C4
C 1460	CHIP CAP.	1uF	10V	B	GRM40B105K10PT(0.85)	K22100803		1-	B	e5
C 1461	CHIP CAP.	0.01uF	16V	B	GRM36B103K16PT	K22128804		1-	B	d5
C 1462	CHIP CAP.	100pF	50V	UJ	GRP1553U1H101JZ01E	K22178323		1-	B	e4
C 1463	CHIP CAP.	0.01uF	16V	B	GRM36B103K16PT	K22128804		1-	B	d5
C 1464	CHIP CAP.	27pF	50V	UJ	GRP1553U1H270JZ01E	K22178316		1-	B	d5
C 1465	CHIP CAP.	3pF	50V	UJ	GRP1553U1H3R0CZ01E	K22178304		1-	B	d4
C 1466	CHIP CAP.	270pF	25V	CH	GRM36CH271J25PT	K22148248		1-	B	d4
C 1467	CHIP CAP.	0.001uF	50V	B	GRM36B102K50PT	K22178809		1-	B	d4
C 1468	CHIP CAP.	0.001uF	50V	B	GRM36B102K50PT	K22178809		1-	A	C4
C 1469	CHIP CAP.	0.022uF	16V	B	GRM36B223K16PT	K22128806		1-	A	C4
C 1470	CHIP CAP.	0.1uF	16V	B	GRM39B104K16PT	K22124805		1-	A	C4
C 1471	CHIP TA.CAP.	10uF	10V		TEMSVA1A106M-8R	K78100028		1-	A	C4
C 1472	CHIP CAP.	0.1uF	16V	B	GRM39B104K16PT	K22124805		1-	A	C4
C 1473	CHIP CAP.	0.1uF	10V	B	GRM36B104K10PT	K22108802		1-	A	C4
C 1474	CHIP TA.CAP.	0.1uF	20V		SKF-1D104M-RP	K78130049		1-	A	E5
C 1475	CHIP CAP.	0.1uF	16V	B	GRM39B104K16PT	K22124805		1-	A	E5
C 1476	CHIP TA.CAP.	10uF	10V		TEMSVA1A106M-8R	K78100028		1-	A	E5
C 1477	CHIP CAP.	0.1uF	16V	B	GRM39B104K16PT	K22124805		1-	A	E5
C 1478	CHIP CAP.	0.022uF	16V	B	GRM36B223K16PT	K22128806		1-	A	E5
C 1479	CHIP CAP.	33pF	50V	CH	GRM36CH330J50PT	K22178224		1-	A	C5
C 1480	CHIP CAP.	0.001uF	50V	B	GRM36B102K50PT	K22178809		1-	A	D5
C 1481	CHIP CAP.	0.01uF	16V	B	GRM36B103K16PT	K22128804		1-	A	D5
C 1482	CHIP CAP.	0.047uF	10V	B	GRM36B473K10PT	K22108801		1-	A	D5
C 1483	CHIP TA.CAP.	10uF	10V		TEMSVA1A106M-8R	K78100028		1-	A	E5

REF	DESCRIPTION	VALUE	V/W	TOL.	MFR'S DESIG	VXSTD P/N	VERS.	LOT	SIDE	LAY ADR
C 1484	CHIP CAP.	0.001uF	50V	B	GRM39B102K50PT	K22174821		1-	A	D5
C 1485	CHIP CAP.	6pF	50V	UJ	GRP1553U1H6R0DZ01E	K22178307		1-	B	c5
C 1486	CHIP CAP.	47pF	50V	UJ	GRP1553U1H470JZ01E	K22178319		1-	B	c5
C 1487	CHIP CAP.	0.001uF	50V	B	GRM36B102K50PT	K22178809		1-	B	c5
C 1489	CHIP CAP.	100pF	50V	CH	GRM36CH101J50PT	K22178236		1-	B	c5
C 1490	CHIP CAP.	8pF	50V	UJ	GRP1553U1H8R0DZ01E	K22178309		1-	B	c5
C 1491	CHIP CAP.	4pF	50V	UJ	GRP1553U1H4R0CZ01E	K22178305		1-	B	c5
C 1492	CHIP CAP.	100pF	50V	CH	GRM36CH101J50PT	K22178236		1-	B	c5
C 1493	CHIP CAP.	0.1uF	10V	B	GRM36B104K10PT	K22108802		1-	A	D5
C 1494	CHIP CAP.	0.001uF	50V	B	GRM36B102K50PT	K22178809		1-	B	c5
C 1495	CHIP TA.CAP.	10uF	10V		TEMSVA1A106M-8R	K78100028		1-	A	D4
C 1496	CHIP CAP.	0.1uF	10V	B	GRM36B104K10PT	K22108802		1-	B	d4
C 1497	CHIP CAP.	0.001uF	50V	B	GRM36B102K50PT	K22178809		1-	A	A4
C 1498	CHIP CAP.	0.001uF	50V	B	GRM36B102K50PT	K22178809		1-	A	D4
C 1499	CHIP CAP.	0.001uF	50V	B	GRM36B102K50PT	K22178809		1-	B	d4
C 1500	CHIP CAP.	0.001uF	50V	B	GRM36B102K50PT	K22178809		1-	B	d4
C 1501	CHIP CAP.	0.001uF	50V	B	GRM36B102K50PT	K22178809		1-	B	d4
C 1502	CHIP CAP.	0.001uF	50V	B	GRM39B102K50PT	K22174821		1-	B	d4
C 1503	CHIP CAP.	20pF	50V	CH	GRM36CH200J50PT	K22178219		1-	B	d4
C 1504	CHIP CAP.	18pF	50V	CH	GRM36CH180J50PT	K22178218		1-	B	d4
C 1505	CHIP CAP.	10pF	50V	CH	GRM36CH100D50PT	K22178212		1-	B	d4
C 1506	CHIP CAP.	1pF	50V	CK	GRM36CK010B50PT	K22178287		1-	B	d4
C 1507	CHIP CAP.	0.001uF	50V	B	GRM36B102K50PT	K22178809		1-	B	d4
C 1508	CHIP CAP.	0.001uF	50V	B	GRM36B102K50PT	K22178809		1-	B	d4
C 1509	CHIP CAP.	3pF	50V	CJ	GRM36CJ030B50PT	K22178290		1-	A	C4
C 1510	CHIP CAP.	0.001uF	50V	B	GRM36B102K50PT	K22178809		1-	A	C4
C 1511	CHIP CAP.	0.001uF	50V	B	GRM36B102K50PT	K22178809		1-	B	d4
C 1512	CHIP TA.CAP.	0.1uF	20V		SKF-1D104M-RP	K78130049		1-	A	C4
C 1513	CHIP CAP.	150pF	50V	CH	GRM39CH151J50PT	K22174239		1-	A	C4
C 1514	CHIP CAP.	0.001uF	50V	B	GRM36B102K50PT	K22178809		1-	B	d4
C 1515	CHIP CAP.	0.001uF	50V	B	GRM36B102K50PT	K22178809		1-	B	d4
C 1516	CHIP CAP.	0.001uF	50V	B	GRM36B102K50PT	K22178809		1-	A	D4
C 1517	CHIP CAP.	0.001uF	50V	B	GRM39B102K50PT	K22174821		1-	B	d4
C 1518	CHIP CAP.	47pF	50V	CH	GRM36CH470J50PT	K22178228		1-	B	d4
C 1519	CHIP CAP.	22pF	50V	CH	GRM36CH220J50PT	K22178220		1-	B	d4
C 1520	CHIP CAP.	18pF	50V	CH	GRM36CH180J50PT	K22178218		1-	B	d4
C 1521	CHIP CAP.	2pF	50V	CK	GRM36CK020B50PT	K22178289		1-	B	d4
C 1522	CHIP CAP.	0.001uF	50V	B	GRM36B102K50PT	K22178809		1-	A	D4
C 1523	CHIP CAP.	0.001uF	50V	B	GRM36B102K50PT	K22178809		1-	B	d4
C 1524	CHIP CAP.	2pF	50V	CK	GRM36CK020B50PT	K22178289		1-	A	C4
C 1525	CHIP CAP.	0.001uF	50V	B	GRM36B102K50PT	K22178809		1-	B	c4
C 1526	CHIP CAP.	0.001uF	50V	B	GRM36B102K50PT	K22178809		1-	B	c5
C 1527	CHIP CAP.	0.001uF	50V	B	GRM39B102K50PT	K22174821		1-	B	c5
C 1528	CHIP CAP.	18pF	50V	CH	GRM36CH180J50PT	K22178218		1-	B	c4
C 1529	CHIP CAP.	18pF	50V	CH	GRM36CH180J50PT	K22178218		1-	B	c5
C 1530	CHIP CAP.	10pF	50V	CH	GRM36CH100D50PT	K22178212		1-	B	c5
C 1531	CHIP CAP.	1pF	50V	CK	GRM36CK010B50PT	K22178287		1-	B	c5
C 1532	CHIP CAP.	0.001uF	50V	B	GRM36B102K50PT	K22178809		1-	B	a5
C 1533	CHIP CAP.	0.001uF	50V	B	GRM36B102K50PT	K22178809		1-	B	b4
C 1534	CHIP CAP.	2pF	50V	CK	GRM36CK020B50PT	K22178289		1-	A	E4
C 1535	CHIP CAP.	0.001uF	50V	B	GRM36B102K50PT	K22178809		1-	B	c4
C 1536	CHIP CAP.	0.001uF	50V	B	GRM39B102K50PT	K22174821		1-	B	c4
C 1537	CHIP CAP.	47pF	50V	CH	GRM36CH470J50PT	K22178228		1-	B	c4
C 1538	CHIP CAP.	20pF	50V	CH	GRM36CH200J50PT	K22178219		1-	B	c4
C 1540	CHIP CAP.	18pF	50V	CH	GRM36CH180J50PT	K22178218		1-	B	c4
C 1541	CHIP CAP.	2pF	50V	CK	GRM36CK020B50PT	K22178289		1-	B	c4
C 1542	CHIP CAP.	0.001uF	50V	B	GRM36B102K50PT	K22178809		1-	A	E4
C 1543	CHIP CAP.	0.001uF	50V	B	GRM36B102K50PT	K22178809		1-	B	b4
C 1544	CHIP CAP.	1.5pF	50V	CK	GRM36CK1R5B50PT	K22178288		1-	A	E5
C 1545	CHIP CAP.	0.001uF	50V	B	GRM36B102K50PT	K22178809		1-	A	D4
C 1546	CHIP CAP.	0.001uF	50V	B	GRM36B102K50PT	K22178809		1-	B	f3
C 1547	CHIP CAP.	0.001uF	50V	B	GRM36B102K50PT	K22178809		1-	B	e3
C 1548	CHIP CAP.	0.1uF	10V	B	GRM36B104K10PT	K22108802		1-	B	e3
C 1549	CHIP CAP.	0.001uF	50V	B	GRM36B102K50PT	K22178809		1-	B	e3
C 1550	CHIP TA.CAP.	10uF	10V		TEMSVA1A106M-8R	K78100028		1-	B	e3
C 1551	CHIP CAP.	0.047uF	10V	B	GRM36B473K10PT	K22108801		1-	B	e3
C 1552	CHIP CAP.	0.001uF	50V	B	GRM36B102K50PT	K22178809		1-	B	e3
C 1554	CHIP CAP.	0.001uF	50V	B	GRM36B102K50PT	K22178809		1-	B	d3
C 1555	CHIP CAP.	0.001uF	50V	B	GRM36B102K50PT	K22178809		1-	B	d3
C 1556	CHIP CAP.	0.001uF	50V	B	GRM36B102K50PT	K22178809		1-	A	C3
C 1558	CHIP CAP.	0.001uF	50V	B	GRM36B102K50PT	K22178809		1-	A	D3
C 1559	CHIP CAP.	7pF	50V	CH	GRM36CH070B50PT	K22178294		1-	B	d3
C 1560	CHIP CAP.	0.001uF	50V	B	GRM36B102K50PT	K22178809		1-	B	d3
C 1561	CHIP TA.CAP.	22uF	16V		TEMSVB21C226M-8R	K78120028		1-	B	c3
C 1562	CHIP CAP.	0.001uF	50V	B	GRM36B102K50PT	K22178809		1-	B	d3
C 1563	CHIP CAP.	100pF	50V	CH	GRM36CH101J50PT	K22178236		1-	B	d3
C 1564	CHIP CAP.	18pF	50V	CH	GRM36CH180J50PT	K22178218		1-	A	C3

MAIN Unit

REF	DESCRIPTION	VALUE	V/W	TOL.	MFR'S DESIG	VXSTD P/N	VERS.	LOT	SIDE	LAY ADR
C 1565	CHIP CAP.	0.01uF	16V	B	GRM36B103K16PT	K22128804		1-	B	e3
C 1566	CHIP CAP.	0.47uF	25V	B	GRM40B474K25PT	K22140824		1-	B	d3
C 1567	CHIP CAP.	0.022uF	25V	B	GRM39B223K25PT	K22144807		1-	B	d3
C 1568	CHIP CAP.	0.001uF	50V	B	GRM36B102K50PT	K22178809		1-	B	d3
C 1569	CHIP CAP.	8pF	50V	CH	GRM36CH080B50PT	K22178295		1-	A	C3
C 1570	CHIP CAP.	8pF	50V	CH	GRM36CH080B50PT	K22178295		1-	A	C3
C 1571	CHIP CAP.	68pF	50V	CH	GRM36CH680J50PT	K22178232		1-	A	C3
C 1572	CHIP CAP.	82pF	50V	CH	GRM36CH820J50PT	K22178234		1-	A	C3
C 1573	CHIP CAP.	0.001uF	50V	B	GRM36B102K50PT	K22178809		1-	A	C2
C 1574	CHIP CAP.	0.1uF	16V	B	GRM39B104K16PT	K22124805		1-	A	C3
C 1575	CHIP CAP.	0.001uF	50V	B	GRM36B102K50PT	K22178809		1-	A	C3
C 1576	CHIP CAP.	0.001uF	50V	B	GRM36B102K50PT	K22178809		1-	A	D3
C 1577	CHIP CAP.	0.1uF	16V	B	GRM39B104K16PT	K22124805		1-	A	D3
C 1578	CHIP CAP.	0.001uF	50V	B	GRM36B102K50PT	K22178809		1-	B	d3
C 1579	CHIP CAP.	0.1uF	16V	B	GRM39B104K16PT	K22124805		1-	B	d3
C 1580	CHIP CAP.	0.001uF	50V	B	GRM36B102K50PT	K22178809		1-	B	d2
C 1581	CHIP CAP.	0.47uF	25V	B	GRM40B474K25PT	K22140824		1-	A	B3
C 1582	CHIP CAP.	0.001uF	50V	B	GRM39B102K50PT	K22174821		1-	A	B3
C 1583	CHIP CAP.	0.022uF	25V	B	GRM39B223K25PT	K22144807		1-	A	C3
C 1584	CHIP CAP.	0.001uF	50V	B	GRM39B102K50PT	K22174821		1-	A	C3
C 1585	CHIP CAP.	0.47uF	25V	B	GRM40B474K25PT	K22140824		1-	A	B3
C 1586	CHIP CAP.	18pF	50V	CH	GRM39CH180J50PT	K22174217		1-	A	C2
C 1587	CHIP CAP.	10pF	50V	CH	GRM39CH100D50PT	K22174211		1-	A	C2
C 1588	CHIP CAP.	39pF	50V	CH	GRM39CH390J50PT	K22174225		1-	A	C2
C 1589	CHIP CAP.	0.1uF	16V	B	GRM39B104K16PT	K22124805		1-	B	e2
C 1590	CHIP CAP.	0.001uF	50V	B	GRM36B102K50PT	K22178809		1-	B	e2
C 1591	CHIP CAP.	33pF	50V	CH	GRM39CH330J50PT	K22174223		1-	A	C2
C 1592	CHIP CAP.	0.1uF	16V	B	GRM39B104K16PT	K22124805		1-	B	e2
C 1593	CHIP CAP.	33pF	50V	CH	GRM39CH330J50PT	K22174223		1-	A	B2
C 1594	CHIP CAP.	15pF	50V	CH	GRM39CH150J50PT	K22174215		1-	A	B2
C 1595	CHIP CAP.	22pF	50V	CH	GRM39CH220J50PT	K22174219		1-	A	C2
C 1596	CHIP CAP.	10pF	50V	CH	GRM36CH100D50PT	K22178212		1-	A	C2
C 1598	CHIP CAP.	150pF	50V	CH	GRM39CH151J50PT	K22174239		1-	A	C2
C 1599	FILM CAP.	47pF	500V		UC232H0470J-T	K33279034		1-	A	C2
C 1600	CHIP CAP.	15pF	50V	CH	GRM39CH150J50PT	K22174215		1-	A	C1
C 1601	CHIP CAP.	0.1uF	16V	B	GRM39B104K16PT	K22124805		1-	B	e1
C 1602	CHIP CAP.	0.001uF	50V	B	GRM39B102K50PT	K22174821		1-	B	e1
C 1603	FILM CAP.	47pF	500V		UC232H0470J-T	K33279034		1-	A	C2
C 1604	FILM CAP.	39pF	500V		UC232H0390J-T	K33279038		1-	A	C1
C 1605	CHIP TA.CAP.	1uF	25V		TEMSVA1E105M-8R	K78140013		1-	B	e1
C 1606	CHIP CAP.	0.47uF	25V	B	GRM40B474K25PT	K22140824		1-	B	d1
C 1607	CHIP CAP.	0.001uF	50V	B	GRM39B102K50PT	K22174821		1-	B	d1
C 1608	CHIP CAP.	100pF	200V	CH	GRM40CH101J200PT	K22230228		1-	B	d1
C 1609	FILM CAP.	47pF	500V		UC232H0470J-T	K33279034		1-	A	D1
C 1610	FILM CAP.	47pF	500V		UC232H0470J-T	K33279034		1-	A	D2
C 1611	CHIP CAP.	0.001uF	50V	B	GRM36B102K50PT	K22178809		1-	B	a3
C 1613	CHIP CAP.	0.001uF	50V	B	GRM39B102K50PT	K22174821		1-	A	D3
C 1614	CHIP CAP.	0.001uF	50V	B	GRM36B102K50PT	K22178809		1-	A	D3
C 1615	CHIP CAP.	0.001uF	50V	B	GRM36B102K50PT	K22178809		1-	A	D2
C 1617	CHIP CAP.	5pF	200V	CH	GRM1882C2D5R0CV01D	K22234207		1-	A	D1
C 1618	FILM CAP.	56pF	500V		UC232H0560J-T	K33279035		1-	A	D1
C 1619	FILM CAP.	56pF	500V		UC232H0560J-T	K33279035		1-	A	D1
C 1620	CHIP CAP.	27pF	200V	CH	GRM40CH270J200PT	K22230221		1-	B	b1
C 1621	CHIP CAP.	27pF	200V	CH	GRM40CH270J200PT	K22230221		1-	B	c1
C 1623	CHIP CAP.	220pF	200V	CH	GRM40CH221J200PT	K22230232		1-	B	b1
C 1624	CHIP CAP.	220pF	200V	CH	GRM40CH221J200PT	K22230232		1-	B	b1
C 1625	CHIP CAP.	0.5pF	200V	CK	GRM1884C2DR50CY21D	K22234201		1-	B	b1
C 1626	CHIP CAP.	22pF	200V	CH	GRM40CH220J200PT	K22230220		1-	B	b1
C 1627	CHIP CAP.	5pF	50V	CH	GRM36CH050B50PT	K22178292		1-	B	b1
C 1628	CHIP CAP.	0.001uF	50V	B	GRM36B102K50PT	K22178809		1-	B	b1
C 1629	CHIP CAP.	22pF	200V	CH	GRM40CH220J200PT	K22230220		1-	B	b1
C 1630	CHIP CAP.	7pF	200V	CH	GRM1882C2D7R0DV01D	K22234209		1-	B	b1
C 1631	CHIP CAP.	22pF	200V	CH	GRM40CH220J200PT	K22230220		1-	B	b1
C 1632	CHIP CAP.	27pF	200V	CH	GRM40CH270J200PT	K22230221		1-	B	a1
C 1633	CHIP CAP.	0.5pF	200V	CK	GRM1884C2DR50CY21D	K22234201		1-	B	a1
C 1634	CHIP CAP.	0.0047uF	25V	B	GRM36B472K25PT	K22148830		1-	B	c2
C 1635	CHIP CAP.	0.001uF	50V	B	GRM36B102K50PT	K22178809		1-	B	a1
C 1636	CHIP CAP.	4pF	50V	CH	GRM36CH040B50PT	K22178291		1-	B	a1
C 1637	CHIP CAP.	0.001uF	50V	B	GRM36B102K50PT	K22178809		1-	A	F2
C 1638	CHIP CAP.	0.01uF	16V	B	GRM36B103K16PT	K22128804		1-	A	F2
C 1639	CHIP CAP.	33pF	50V	CH	GRM36CH330J50PT	K22178224		1-	A	C2
C 1640	CHIP CAP.	56pF	50V	CH	GRM36CH560J50PT	K22178230		1-	A	C2
C 1641	CHIP CAP.	0.001uF	50V	B	GRM36B102K50PT	K22178809		1-	A	B2
C 1642	CHIP CAP.	0.001uF	50V	B	GRM36B102K50PT	K22178809		1-	A	B2
C 1643	CHIP CAP.	0.001uF	50V	B	GRM36B102K50PT	K22178809		1-	B	b2
C 1644	CHIP CAP.	24pF	50V	CH	GRM36CH240J50PT	K22178221		1-	B	b2
C 1645	CHIP CAP.	15pF	50V	CH	GRM36CH150J50PT	K22178216		1-	B	b2

REF	DESCRIPTION	VALUE	V/W	TOL.	MFR'S DESIG	VXSTD P/N	VERS.	LOT	SIDE	LAY ADR
C 1647	CHIP CAP.	18pF	200V	CH	GRM40CH180J200PT	K22230219		1-	B	a2
C 1648	CHIP CAP.	220pF	200V	CH	GRM40CH221J200PT	K22230232		1-	B	a2
C 1649	CHIP CAP.	220pF	200V	CH	GRM40CH221J200PT	K22230232		1-	B	a2
C 1650	CHIP CAP.	15pF	200V	CH	GRM40CH150J200PT	K22230218		1-	B	a2
C 1651	CHIP CAP.	15pF	200V	CH	GRM40CH150J200PT	K22230218		1-	B	a2
C 1652	FILM CAP.	12pF	500V		UC232H0120J-T	K33279020		1-	A	D2
C 1653	CHIP CAP.	100pF	200V	CH	GRM40CH101J200PT	K22230228		1-	A	E2
C 1654	CHIP CAP.	100pF	200V	CH	GRM40CH101J200PT	K22230228		1-	A	E2
C 1657	CHIP CAP.	0.5pF	200V	CK	GRM1884C2DR50CY21D	K22234201		1-	B	c2
C 1658	CHIP CAP.	6pF	50V	CH	GRM36CH060B50PT	K22178293		1-	B	c2
C 1659	CHIP CAP.	0.001uF	50V	B	GRM36B102K50PT	K22178809		1-	B	c2
C 1660	CHIP CAP.	3pF	200V	CJ	GRM1883C2D3R0CV01D	K22234205		1-	A	E2
C 1661	CHIP CAP.	3pF	200V	CJ	GRM1883C2D3R0CV01D	K22234205		1-	A	E2
C 1662	CHIP CAP.	6pF	200V	CH	GRM1882C2D6R0DV01D	K22234208		1-	A	E2
C 1663	CHIP CAP.	0.5pF	200V	CK	GRM1884C2DR50CY21D	K22234201		1-	A	E2
C 1664	CHIP CAP.	0.001uF	50V	B	GRM36B102K50PT	K22178809		1-	A	E2
C 1665	CHIP CAP.	4pF	50V	CH	GRM36CH040B50PT	K22178291		1-	A	E2
C 1666	CHIP CAP.	1.5pF	200V	CK	GRM1884C2D1R5CV01D	K22234213		1-	A	F3
C 1667	CHIP CAP.	3pF	200V	CJ	GRM1883C2D3R0CV01D	K22234205		1-	A	E3
C 1668	CHIP CAP.	4pF	200V	CH	GRM1882C2D4R0CV01D	K22234206		1-	A	F2
C 1669	CHIP CAP.	4pF	200V	CH	GRM1882C2D4R0CV01D	K22234206		1-	A	F2
C 1670	CHIP CAP.	0.5pF	200V	CK	GRM1884C2DR50CY21D	K22234201		1-	A	F3
C 1671	CHIP CAP.	2pF	200V	CK	GRM1884C2D2R0CV01D	K22234204		1-	A	F3
C 1672	CHIP CAP.	2pF	200V	CK	GRM1884C2D2R0CV01D	K22234204		1-	A	F3
C 1673	CHIP CAP.	4pF	200V	CH	GRM1882C2D4R0CV01D	K22234206		1-	A	F3
C 1674	CHIP CAP.	4pF	200V	CH	GRM1882C2D4R0CV01D	K22234206		1-	A	F3
C 1676	CHIP CAP.	0.001uF	50V	B	GRM36B102K50PT	K22178809		1-	B	b5
C 1678	CHIP CAP.	0.001uF	50V	B	GRM36B102K50PT	K22178809		1-	B	b5
C 1680	CHIP CAP.	1uF	10V	F	GRM39F105Z10PT	K22105001		1-	B	f4
C 1681	CHIP CAP.	11pF	50V	CH	GRM39CH110J50PT	K22174212		1-		
C 1688	CHIP CAP.	0.001uF	50V	B	GRM36B102K50PT	K22178809		1-		
CD1001	CERAMIC DISC				CDBM450C24	H7901390		1-	A	B4
CD1002	CERAMIC DISC				CDBM450C24	H7901390		1-	A	C5
CF1001	CERAMIC FILTER				CFWM450E	H3900466		1-	A	B3
CF1002	CERAMIC FILTER				CFWM450G	H3900435		1-	A	B3
CF1003	CERAMIC FILTER				CFWM450E	H3900466		1-	A	C5
CF1004	CERAMIC FILTER				CFWM450G	H3900435		1-	A	D5
D 1001	DIODE				HSC277TRF	G2070584		1-	B	b3
D 1002	DIODE				HSC277TRF	G2070584		1-	B	c3
D 1003	DIODE				HVC131TRF	G2070676		1-	A	E3
D 1004	DIODE				HVC350B-TRF	G2070596		1-	B	c3
D 1005	DIODE				HVC350B-TRF	G2070596		1-	B	c3
D 1006	DIODE				HVC350B-TRF	G2070596		1-	B	c3
D 1007	DIODE				HVC131TRF	G2070676		1-	B	c3
D 1008	DIODE				HVC131TRF	G2070676		1-	B	c3
D 1009	DIODE				HSC277TRF	G2070584		1-	B	b4
D 1010	DIODE				HVC131TRF	G2070676		1-	B	b4
D 1011	DIODE				HVC350B-TRF	G2070596		1-	B	b4
D 1012	DIODE				HVC350B-TRF	G2070596		1-	B	b4
D 1013	DIODE				HVC350B-TRF	G2070596		1-	B	b4
D 1014	DIODE				HVC131TRF	G2070676		1-	A	E5
D 1015	DIODE				HSC277TRF	G2070584		1-	B	b5
D 1017	DIODE				HVC365 TRF	G2070902		1-	B	c4
D 1018	DIODE				HVC365 TRF	G2070902		1-	B	c4
D 1019	DIODE				HVC365 TRF	G2070902		1-	B	c4
D 1020	DIODE				HVC365 TRF	G2070902		1-	B	a4
D 1021	DIODE				HVC365 TRF	G2070902		1-	B	a4
D 1022	DIODE				HVC365 TRF	G2070902		1-	B	a4
D 1023	DIODE				HVC131TRF	G2070676		1-	A	E5
D 1026	DIODE				HVC131TRF	G2070676		1-	A	D4
D 1027	DIODE				HVC131TRF	G2070676		1-	A	D4
D 1028	DIODE				HVC131TRF	G2070676		1-	A	E5
D 1029	DIODE				RLS135 TE-11	G2070128		1-	B	b2
D 1030	DIODE				RLS135 TE-11	G2070128		1-	B	b2
D 1031	DIODE				DAN222 TL	G2070174		1-	B	a4
D 1032	DIODE				HVC131TRF	G2070676		1-	B	c3
D 1033	DIODE				HVC131TRF	G2070676		1-	A	E5
D 1034	DIODE				HVC131TRF	G2070676		1-	A	C3
D 1035	DIODE				DAN222 TL	G2070174		1-	A	C4
D 1036	DIODE				MA2S72800L	G2070858		1-	B	f4
D 1037	DIODE				DAN222 TL	G2070174		1-	A	D5
D 1038	DIODE				MA2S72800L	G2070858		1-	B	d5
D 1039	DIODE				HSC277TRF	G2070584		1-	B	e3
D 1040	DIODE				HSC277TRF	G2070584		1-	B	e3
D 1041	DIODE				HSC277TRF	G2070584		1-	B	e3
D 1042	DIODE				HSC277TRF	G2070584		1-	B	e3
D 1043	DIODE				HSC277TRF	G2070584		1-	B	d5

MAIN Unit

REF	DESCRIPTION	VALUE	V/W	TOL.	MFR'S DESIG	VXSTD P/N	VERS.	LOT	SIDE	LAY ADR
D 1044	DIODE				HSC277TRF	G2070584		1-	B	d5
D 1045	DIODE				HSC277TRF	G2070584		1-	B	d5
D 1046	DIODE				HSC277TRF	G2070584		1-	B	c5
D 1047	DIODE				DAN222 TL	G2070174		1-	B	f4
D 1048	DIODE				DAN222 TL	G2070174		1-	B	f4
D 1049	DIODE				DAN222 TL	G2070174		1-	A	B3
D 1050	DIODE				DAN222 TL	G2070174		1-	A	B3
D 1051	DIODE				DA221 TL	G2070178		1-	A	A4
D 1052	DIODE				DA221 TL	G2070178		1-	B	f5
D 1053	DIODE				HZM27WA-TR	G2070530		1-	B	e5
D 1054	DIODE				HZM27WA-TR	G2070530		1-	B	e5
D 1055	DIODE				DAN222 TL	G2070174		1-	A	A2
D 1056	SURGE ABSORBER				P6KA18	Q9000721		1-	A	B1
D 1057	DIODE				D1F20-4063	G2070474		1-	B	g3
D 1058	DIODE				DAN222 TL	G2070174		1-	B	g4
D 1059	DIODE				DAN222 TL	G2070174		1-	B	g4
D 1060	DIODE				DAN222 TL	G2070174		1-	B	f5
D 1061	DIODE				DAP222-TL	G2070432		1-	A	G5
D 1062	DIODE				DAP222-TL	G2070432		1-	A	G5
D 1063	DIODE				DAN222 TL	G2070174		1-	A	F5
D 1064	DIODE				DAP222-TL	G2070432		1-	A	F5
D 1065	DIODE				DAP222-TL	G2070432		1-	A	F5
D 1066	DIODE				DAN222 TL	G2070174		1-	A	F5
D 1067	DIODE				DAP222-TL	G2070432		1-	A	F5
D 1068	DIODE				DA221 TL	G2070178		1-	A	C4
D 1069	DIODE				HVC365 TRF	G2070902		1-	B	d4
D 1070	DIODE				HVC365 TRF	G2070902		1-	B	e5
D 1071	DIODE				HVC350B-TRF	G2070596		1-	B	d5
D 1072	DIODE				HVC365 TRF	G2070902		1-	B	d4
D 1073	DIODE				DA221 TL	G2070178		1-	B	d5
D 1074	DIODE				DA221 TL	G2070178		1-	A	E5
D 1075	DIODE				HVC365 TRF	G2070902		1-	B	c5
D 1076	DIODE				HVC365 TRF	G2070902		1-	B	c5
D 1077	DIODE				HVC365 TRF	G2070902		1-	B	c5
D 1078	DIODE				DA221 TL	G2070178		1-	B	c5
D 1079	DIODE				HVC375B-TRF	G2070856		1-	B	d4
D 1080	DIODE				HVC350B-TRF	G2070596		1-	B	d4
D 1081	DIODE				HSC277TRF	G2070584		1-	B	d4
D 1082	DIODE				HVC365 TRF	G2070902		1-	B	d4
D 1083	DIODE				HVC131TRF	G2070676		1-	B	d4
D 1084	DIODE				HVC362TRF	G2070636		1-	B	d4
D 1085	DIODE				HVC365 TRF	G2070902		1-	B	d4
D 1086	DIODE				HSC277TRF	G2070584		1-	A	C4
D 1087	DIODE				HSC277TRF	G2070584		1-	A	C4
D 1088	DIODE				DAN222 TL	G2070174		1-	B	e4
D 1089	DIODE				HSC277TRF	G2070584		1-	A	D3
D 1090	DIODE				HVC375B-TRF	G2070856		1-	B	c4
D 1091	DIODE				HVC350B-TRF	G2070596		1-	B	c5
D 1092	DIODE				HSC277TRF	G2070584		1-	B	c5
D 1093	DIODE				HVC131TRF	G2070676		1-	A	E5
D 1094	DIODE				HVC365 TRF	G2070902		1-	B	c4
D 1095	DIODE				HVC365 TRF	G2070902		1-	B	c4
D 1096	DIODE				HVC362TRF	G2070636		1-	B	c4
D 1097	DIODE				HVC131TRF	G2070676		1-	A	E4
D 1098	DIODE				DAN222 TL	G2070174		1-	A	D4
D 1099	DIODE				HSC277TRF	G2070584		1-	A	C3
D 1100	DIODE				DAN222 TL	G2070174		1-	B	e3
D 1101	DIODE				HSC277TRF	G2070584		1-	B	d3
D 1102	DIODE				HSC277TRF	G2070584		1-	B	d3
D 1103	DIODE				HZM13NB2 TR	G2070894		1-	B	d3
D 1104	DIODE				DAN222 TL	G2070174		1-	A	D3
D 1105	DIODE				HSC277TRF	G2070584		1-	A	C3
D 1106	DIODE				HSC277TRF	G2070584		1-	A	C3
D 1107	DIODE				HSC277TRF	G2070584		1-	A	C2
D 1108	DIODE				RLS135 TE-11	G2070128		1-	A	C2
D 1109	DIODE				MA2S72800L	G2070858		1-	B	b1
D 1110	DIODE				MA2S72800L	G2070858		1-	B	b1
D 1111	DIODE				HSC277TRF	G2070584		1-	A	B2
D 1112	DIODE				HSC277TRF	G2070584		1-	A	B2
D 1113	DIODE				UM9957F/TR	G2070562		1-	A	F1
D 1114	DIODE				UM9957F/TR	G2070562		1-	A	F1
D 1115	DIODE				RLS135 TE-11	G2070128		1-	A	F2
D 1116	DIODE				RLS135 TE-11	G2070128		1-	A	F2
D 1117	DIODE				HSC277TRF	G2070584		1-	B	b2
D 1118	DIODE				UM9957F/TR	G2070562		1-	A	E2
D 1119	DIODE				UM9957F/TR	G2070562		1-	A	E2
D 1120	DIODE				UM9957F/TR	G2070562		1-	A	E2

REF	DESCRIPTION	VALUE	V/W	TOL.	MFR'S DESIG	VXSTD P/N	VERS.	LOT	SIDE	LAY ADR
D 1121	DIODE				MA2S72800L	G2070858		1-	B	c2
D 1122	DIODE				MA2S72800L	G2070858		1-	A	E2
D 1123	SURGE ABSORBER				RCCA-201Q43UA	Q9000755		1-	A	F2
D 1125	DIODE				MA2S111-(TX)	G2070614		1-		
FB1001	BEADS COIL				B-01-A	L1190386		1-	A	B1
FB1002	FERRITE BEADS				SMB304729	L9190094		1-	A	C1
FB1003	FERRITE BEADS				SMB304729	L9190094		1-	A	B3
HS1001	HEATSINK PLATE					RA0227600		1-	B	d3
J 1001	CONNECTOR				HSJ6062-01-440	P1090983		1-	A	A1
J 1002	CONNECTOR				SC25-02WS	P0090621		1-	A	A3
J 1003	CONNECTOR				MD-S6000-90	P1091087		1-	B	f1
J 1004	CONNECTOR				B2B-ZR	P0090647		1-	A	B1
J 1005	CONNECTOR				MJ-66J-RD315K	P1091049		1-	A	B6
JP1000	WIRE ASSY				GRN 30 2/2	T50503000		1-		
JP1001	WIRE ASSY				GRN 20 2/2	T50502000		1-		
JP1002	WIRE ASSY				GRN 20 2/2	T50502000		1-		
L 1001	M.RFC	0.015uH		2%	C1608CA-15NG	L1691034		1-	B	b2
L 1002	M.RFC	0.01uH		2%	C1608CA-10NG	L1691032		1-	B	b3
L 1003	M.RFC	0.039uH		2%	C1608CA-39NG	L1691039		1-	B	b3
L 1004	M.RFC	0.039uH		2%	C1608CA-39NG	L1691039		1-	B	b3
L 1005	M.RFC	0.01uH			TFL0510-10N	L1690811		1-	B	c3
L 1006	M.RFC	0.1uH			TFL0816-100N	L1690981		1-	B	c3
L 1007	M.RFC	0.01uH		2%	C1608CA-10NG	L1691032		1-	B	c3
L 1008	COIL				E2 0.28-1.0-4T-R	L0022365		1-	B	c3
L 1009	COIL				E2 0.28-1.0-4T-R	L0022365		1-	B	c3
L 1010	M.RFC	0.015uH			TFL0816-15	L1690493		1-	A	D3
L 1011	M.RFC	0.015uH			TFL0816-15	L1690493		1-	A	D3
L 1012	M.RFC	0.015uH			TFL0816-15	L1690493		1-	B	c3
L 1013	M.RFC	0.1uH			TFL0816-100N	L1690981		1-	B	b4
L 1014	M.RFC	0.01uH		2%	C1608CA-10NG	L1691032		1-	B	b4
L 1015	COIL				E2 0.28-1.0-4T-R	L0022365		1-	B	b4
L 1016	COIL				E2 0.28-1.0-4T-R	L0022365		1-	B	b4
L 1017	M.RFC	0.015uH			TFL0816-15	L1690493		1-	B	b4
L 1018	M.RFC	0.015uH			TFL0816-15	L1690493		1-	B	b4
L 1019	M.RFC	0.015uH			TFL0816-15	L1690493		1-	B	b5
L 1020	M.RFC	0.1uH		2%	C1608CA-R10G	L1691045		1-	B	b2
L 1021	M.RFC	0.056uH		2%	C1608CA-56NG	L1691041		1-	B	b2
L 1022	M.RFC	0.043uH		2%	C1608CA-43NG	L1691099		1-	B	b2
L 1023	M.RFC	0.043uH		2%	C1608CA-43NG	L1691099		1-	B	b2
L 1024	M.RFC	0.15uH		2%	C1608CA-R15G	L1691101		1-	B	b3
L 1025	M.RFC	1uH			LK1608 1R0K-T	L1690687		1-	B	b3
L 1026	M.RFC	0.082uH		2%	C1608CA-82NG	L1691044		1-	B	b4
L 1027	M.RFC	0.082uH		2%	C1608CA-82NG	L1691044		1-	B	c3
L 1028	M.RFC	0.082uH		2%	C1608CA-82NG	L1691044		1-	B	c3
L 1029	M.RFC	0.047uH			TFL0816-47	L1690499		1-	B	c4
L 1030	M.RFC	1uH			LK1608 1R0K-T	L1690687		1-	B	b4
L 1031	M.RFC	0.082uH		2%	C1608CA-82NG	L1691044		1-	B	b4
L 1032	M.RFC	0.082uH		2%	C1608CA-82NG	L1691044		1-	B	b4
L 1033	M.RFC	0.082uH		2%	C1608CA-82NG	L1691044		1-	B	b4
L 1034	M.RFC	0.047uH			TFL0816-47	L1690499		1-	B	b5
L 1035	M.RFC	0.068uH		2%	C1608CA-68NG	L1691042		1-	B	b2
L 1036	M.RFC	0.022uH		2%	C1608CA-22NG	L1691036		1-	B	b2
L 1037	M.RFC	0.022uH		2%	C1608CA-22NG	L1691036		1-	B	b3
L 1038	M.RFC	0.082uH		2%	C1608CA-82NG	L1691044		1-	B	b3
L 1039	M.RFC	0.039uH			TFL0816-39	L1690498		1-	B	c4
L 1040	M.RFC	0.039uH			TFL0816-39	L1690498		1-	B	c4
L 1041	M.RFC	0.039uH			TFL0816-39	L1690498		1-	A	F4
L 1042	M.RFC	0.039uH			TFL0816-39	L1690498		1-	A	E4
L 1043	M.RFC	0.01uH			TFL0816-10	L1690491		1-	B	a3
L 1044	M.RFC	0.01uH			TFL0816-10	L1690491		1-	B	a3
L 1045	M.RFC	0.0047uH			TFL0816-4N7	L1690487		1-	B	a3
L 1046	M.RFC	0.0047uH			TFL0816-4N7	L1690487		1-	A	F3
L 1047	M.RFC	0.0047uH			TFL0816-4N7	L1690487		1-	A	F4
L 1048	M.RFC	0.0047uH			TFL0816-4N7	L1690487		1-	A	F4
L 1049	M.RFC	0.0047uH			TFL0816-4N7	L1690487		1-	A	F4
L 1050	M.RFC	0.0033uH			TFL0816-3N3	L1690485		1-	A	E4
L 1051	M.RFC	0.0047uH			TFL0816-4N7	L1690487		1-	A	E4
L 1052	M.RFC	0.0047uH			TFL0816-4N7	L1690487		1-	A	D3
L 1053	M.RFC	0.0047uH			TFL0816-4N7	L1690487		1-	A	E4
L 1054	M.RFC	0.0047uH			TFL0816-4N7	L1690487		1-	A	E4
L 1055	M.RFC	0.0047uH			TFL0816-4N7	L1690487		1-	A	E4
L 1056	M.RFC	0.022uH			TFL0816-22	L1690495		1-	B	d3
L 1057	M.RFC	0.39uH		2%	C1608CA-R39G	L1691107		1-	B	d4
L 1058	M.RFC	0.39uH		2%	C1608CA-R39G	L1691107		1-	A	B4
L 1059	M.RFC	1uH			LK1608 1R0K-T	L1690687		1-	B	e4
L 1060	M.RFC	0.39uH		2%	C1608CA-R39G	L1691107		1-	A	E5
L 1061	M.RFC	0.39uH		2%	C1608CA-R39G	L1691107		1-	A	D5

MAIN Unit

REF	DESCRIPTION	VALUE	V/W	TOL.	MFR'S DESIG	VXSTD P/N	VERS.	LOT	SIDE	LAY ADR
L 1062	M.RFC	1uH			LK1608 1R0K-T	L1690687		1-	B	c5
L 1063	M.RFC	0.39uH		2%	C1608CA-R39G	L1691107		1-	B	e4
L 1064	M.RFC	1uH			ELJ-ND1R0JF	L1690977		1-	B	e4
L 1065	M.RFC	0.39uH		2%	C1608CA-R39G	L1691107		1-	A	D5
L 1066	M.RFC	1uH			LK1608 1R0K-T	L1690687		1-	B	f5
L 1067	M.RFC	150uH			FLC32T-151J	L1690229		1-	B	f4
L 1068	M.RFC	1uH			ELJ-ND1R0JF	L1690977		1-	A	D5
L 1069	M.RFC	1uH			LK1608 1R0K-T	L1690687		1-	A	C4
L 1070	M.RFC	1uH			LK1608 1R0K-T	L1690687		1-	B	d4
L 1071	COIL				E2 0.3-1.1-3T-R	L0022579		1-	B	d4
L 1072	M.RFC	0.0039uH			TFL0816-3N9	L1690486		1-	B	d4
L 1073	M.RFC	0.022uH			TFL0816-22	L1690495		1-	B	d4
L 1074	M.RFC	1uH			LK1608 1R0K-T	L1690687		1-	B	d4
L 1075	CHIP COIL	0.056uH			LQN21A56NG04	L1690978		1-	B	d4
L 1076	M.RFC	0.0022uH			TFL0510-2N2	L1690803		1-	B	d4
L 1077	M.RFC	0.15uH			LK1608 R15K-T	L1690409		1-	B	d4
L 1078	M.RFC	1uH			LK1608 1R0K-T	L1690687		1-	B	c4
L 1079	COIL				E2 0.3-1.1-3T-R	L0022579		1-	B	c5
L 1080	M.RFC	0.0039uH			TFL0816-3N9	L1690486		1-	B	c5
L 1081	M.RFC	0.022uH			TFL0816-22	L1690495		1-	B	b4
L 1082	M.RFC	1uH			LK1608 1R0K-T	L1690687		1-	B	c4
L 1083	CHIP COIL	0.056uH			LQN21A56NG04	L1690978		1-	B	c4
L 1084	M.RFC	0.0082uH			TFL0510-8N2	L1690810		1-	B	c4
L 1085	M.RFC	0.15uH			LK1608 R15K-T	L1690409		1-	B	b4
L 1086	M.RFC	1uH			LK1608 1R0K-T	L1690687		1-	B	e3
L 1087	M.RFC	0.047uH			TFL0816-47	L1690499		1-	B	d3
L 1088	M.RFC	0.015uH			TFL0816-15	L1690493		1-	B	d3
L 1089	M.RFC	0.1uH		2%	C1608CA-R10G	L1691045		1-	A	B3
L 1090	M.RFC	0.0082uH			TFL0816-8N2	L1690490		1-	A	C3
L 1091	COIL				E2 0.35-1.6-4.5T-L	L0022577		1-	A	C3
L 1092	COIL				E2 0.3-1.1-3T-R	L0022579		1-	A	C3
L 1093	COIL				E2 0.4-1.3-2T-L	L0022580		1-	A	C3
L 1094	COIL				E2 0.28-1.0-7TR	L0022422		1-	A	C3
L 1095	COIL	0.056uH			AS050635-56N	L0022813		1-	A	C3
L 1096	COIL				E2 0.4-1.3-2T-L	L0022580		1-	A	C2
L 1097	COIL				E2 0.45-1.4-2.5T-L	L0022618		1-	A	C2
L 1098	M.RFC	1uH			ELJ-ND1R0JF	L1690977		1-	B	e2
L 1099	COIL				E2 0.35-1.6-5.5T-L	L0022616		1-	A	C2
L 1100	COIL				E2 0.35-1.6-7T-L	L0022390		1-	A	B2
L 1101	M.RFC	1uH			ELJ-ND1R0JF	L1690977		1-	B	e2
L 1102	COIL	0.012uH			AS080336-12N	L0022810		1-	A	C1
L 1103	COIL A1				12.5T3.5D0.8UEW R	L0022828		1-	A	D1
L 1104	M.RFC	0.47uH			LK2125 R47K-T	L1690315		1-	B	a4
L 1105	M.RFC	0.47uH			LK2125 R47K-T	L1690315		1-	A	D3
L 1106	COIL A1				3.5T3.5D1.0UEW R	L0022805		1-	A	E1
L 1107	COIL A1				1.5T3.0D1.2UEW R	L0022806		1-	A	E1
L 1108	COIL A1				4.5T3.5D1.0UEW R	L0022836		1-	A	E1
L 1109	COIL A1				3.5T3.5D1.0UEW R	L0022805		1-	A	F1
L 1110	COIL				E2 0.4-3.0-11.5T-L	L0022646		1-	A	F2
L 1111	COIL	0.038uH			AS050630-38N	L0022818		1-	A	F1
L 1112	M.RFC	0.039uH		2%	C1608CA-39NG	L1691039		1-	B	b2
L 1113	COIL A1				3.5T3.5D1.0UEW R	L0022805		1-	A	F2
L 1114	COIL A1				3.5T3.5D1.0UEW R	L0022805		1-	A	F2
L 1115	COIL	0.01uH			AS1003-10NK	L0022544		1-	A	D2
L 1116	COIL				E2 0.25-1.9-5.5T-R	L0022610		1-	A	E2
L 1117	COIL	0.015uH			AS100440-15N	L0022811		1-	A	E2
L 1118	COIL	0.014uH			AS050425-14NK	L0022583		1-	A	E3
L 1119	COIL	0.015uH			AS100440-15N	L0022811		1-	A	E2
L 1120	COIL	0.015uH			AS0803-15NK	L0022536		1-	A	F3
L 1121	COIL	0.012uH			AS080336-12N	L0022810		1-	A	F3
Q 1001	FET				3SK296ZQ-TL	G4802968		1-	B	b3
Q 1002	FET				3SK296ZQ-TL	G4802968		1-	B	b3
Q 1003	FET				3SK296ZQ-TL	G4802968		1-	B	c3
Q 1004	TRANSISTOR				2SC5006-T1	G3350068		1-	A	D3
Q 1005	FET				3SK296ZQ-TL	G4802968		1-	B	b5
Q 1006	TRANSISTOR				2SC5006-T1	G3350068		1-	B	b5
Q 1014	FET				3SK296ZQ-TL	G4802968		1-	B	b3
Q 1015	FET				3SK296ZQ-TL	G4802968		1-	B	b3
Q 1016	FET				3SK296ZQ-TL	G4802968		1-	B	c4
Q 1017	FET				3SK296ZQ-TL	G4802968		1-	B	a5
Q 1018	FET				3SK296ZQ-TL	G4802968		1-	B	b3
Q 1019	FET				3SK296ZQ-TL	G4802968		1-	B	a3
Q 1020	TRANSISTOR				2SC5277-D2-TL	G3352778B		1-	A	F3
Q 1021	TRANSISTOR				2SC5006-T1	G3350068		1-	A	F3
Q 1022	TRANSISTOR				2SC5006-T1	G3350068		1-	A	F4
Q 1023	TRANSISTOR				2SC5374-TL	G3353748		1-	B	c4
Q 1024	TRANSISTOR				2SC5374-TL	G3353748		1-	A	E5

REF	DESCRIPTION	VALUE	V/W	TOL.	MFR'S DESIG	VXSTD P/N	VERS.	LOT	SIDE	LAY ADR
Q 1025	TRANSISTOR				2SC5006-T1	G3350068		1-	A	D3
Q 1026	TRANSISTOR				2SC5006-T1	G3350068		1-	A	E4
Q 1027	TRANSISTOR				2SC4400-3-TL	G3344008C		1-	A	C4
Q 1029	TRANSISTOR				2SC4617 TL R	G3346178R		1-	B	f4
Q 1030	TRANSISTOR				2SC4617 TL R	G3346178R		1-	A	B4
Q 1031	TRANSISTOR				2SC4617 TL R	G3346178R		1-	B	f3
Q 1032	TRANSISTOR				2SC4617 TL R	G3346178R		1-	B	f3
Q 1033	TRANSISTOR				2SC4617 TL R	G3346178R		1-	B	e3
Q 1035	TRANSISTOR				2SC4400-3-TL	G3344008C		1-	A	E5
Q 1036	TRANSISTOR				2SC4617 TL R	G3346178R		1-	B	d5
Q 1037	TRANSISTOR				2SC4617 TL R	G3346178R		1-	B	d5
Q 1038	TRANSISTOR				2SC4617 TL R	G3346178R		1-	A	C5
Q 1039	TRANSISTOR				2SC4617 TL R	G3346178R		1-	A	C5
Q 1040	TRANSISTOR				2SC4617 TL R	G3346178R		1-	B	d4
Q 1042	TRANSISTOR				2SC4400-3-TL	G3344008C		1-	B	e4
Q 1043	TRANSISTOR				2SC4400-3-TL	G3344008C		1-	A	D5
Q 1044	IC				TA31136FN(EL)	G1091605		1-	A	B4
Q 1045	TRANSISTOR				2SC4617 TL R	G3346178R		1-	B	e3
Q 1046	TRANSISTOR				DTC144EE TL	G3070075		1-	B	e3
Q 1047	IC				TA31136FN(EL)	G1091605		1-	A	D5
Q 1048	TRANSISTOR				2SC4617 TL R	G3346178R		1-	B	d5
Q 1049	TRANSISTOR				DTC144EE TL	G3070075		1-	B	d5
Q 1052	IC				NJM2902V-TE1	G1091679		1-	A	A4
Q 1053	IC				NJM2902V-TE1	G1091679		1-	B	f4
Q 1054	IC				NJM2904V-TE1	G1091677		1-	B	f4
Q 1056	TRANSISTOR				2SC4617 TL R	G3346178R		1-	A	B3
Q 1057	TRANSISTOR				2SC4617 TL R	G3346178R		1-	A	A3
Q 1058	TRANSISTOR				DTC144EE TL	G3070075		1-	A	B3
Q 1059	TRANSISTOR				DTC144EE TL	G3070075		1-	A	A4
Q 1060	TRANSISTOR				DTC144EE TL	G3070075		1-	A	A4
Q 1061	TRANSISTOR				DTC144EE TL	G3070075		1-	B	g4
Q 1062	TRANSISTOR				DTC144EE TL	G3070075		1-	B	g4
Q 1063	IC				M51132FP 600C	G1091930		1-	A	A2
Q 1064	TRANSISTOR				CPH6102-TL	G3070223		1-	B	f1
Q 1065	TRANSISTOR				DTC144EE TL	G3070075		1-	B	f1
Q 1066	IC				TC4W66FU TE12L	G1091676		1-	B	f3
Q 1067	IC				TC4W66FU TE12L	G1091676		1-	B	f2
Q 1068	IC				LA4425A	G1092241		1-	A	A2
Q 1069	IC				TDA7233D-TR	G1091112		1-	A	A3
Q 1070	TRANSISTOR				DTC144EE TL	G3070075		1-	A	A1
Q 1071	IC				BU4066BCFV-E2	G1093537		1-	A	B4
Q 1072	TRANSISTOR				DTC144EE TL	G3070075		1-	A	A1
Q 1073	TRANSISTOR				DTC144EE TL	G3070075		1-	B	f4
Q 1074	IC				NJM2902V-TE1	G1091679		1-	A	A4
Q 1075	TRANSISTOR				DTC144EE TL	G3070075		1-	B	e4
Q 1076	TRANSISTOR				2SC4617 TL R	G3346178R		1-	B	e1
Q 1077	TRANSISTOR				DTC144EE TL	G3070075		1-	B	e5
Q 1078	TRANSISTOR				2SB1301-T2 ZQ	G3213017Q		1-	A	B2
Q 1079	TRANSISTOR				2SB1201S-TL	G3070195		1-	B	e2
Q 1080	IC				MM1216ENRE	G1092432		1-	B	e2
Q 1081	IC				NJM78L05UA TE1	G1091325		1-	A	B2
Q 1082	TRANSISTOR				2SC4617 TL R	G3346178R		1-	A	A2
Q 1083	TRANSISTOR				2SA1774 TL R	G3117748R		1-	B	f3
Q 1084	IC				NJM78L05UA TE1	G1091325		1-	B	g3
Q 1085	IC				S-80823CNMC-B8I-T2	G1093635		1-	B	f4
Q 1086	TRANSISTOR				2SC4617 TL R	G3346178R		1-	B	g4
Q 1087	TRANSISTOR				2SC4617 TL R	G3346178R		1-	B	f5
Q 1088	IC				AT24C256N-10SI-1.8	G1093837		1-	B	g5
Q 1089	TRANSISTOR				DTC144EE TL	G3070075		1-	B	f3
Q 1090	TRANSISTOR				UMA8N TR	G3070270		1-	A	G4
Q 1091	TRANSISTOR				UMA8N TR	G3070270		1-	A	G4
Q 1092	TRANSISTOR				UMA8N TR	G3070270		1-	A	F5
Q 1093	TRANSISTOR				UMA8N TR	G3070270		1-	A	F5
Q 1094	TRANSISTOR				DTA144EE TL	G3070074		1-	A	F5
Q 1095	IC				BU2090FS-E1	G1092187		1-	A	F5
Q 1096	TRANSISTOR				IMT17 T110	G3070295		1-	B	a4
Q 1097	TRANSISTOR				DTA144EE TL	G3070074		1-	A	F5
Q 1098	TRANSISTOR				2SC4617 TL R	G3346178R		1-	A	F5
Q 1099	TRANSISTOR				2SC4617 TL R	G3346178R		1-	A	D4
Q 1100	TRANSISTOR				UMA8N TR	G3070270		1-	A	D4
Q 1101	TRANSISTOR				DTA144EE TL	G3070074		1-	A	F5
Q 1102	TRANSISTOR				UMA8N TR	G3070270		1-	A	F5
Q 1103	TRANSISTOR				DTA144EE TL	G3070074		1-	A	D4
Q 1104	IC				M3826AEFGP	※		1-	A	A5
Q 1105	IC				M62353GP 70ED	G1092621		1-	B	f5
Q 1106	TRANSISTOR				DTC144EE TL	G3070075		1-	B	e4
Q 1107	TRANSISTOR				DTC144EE TL	G3070075		1-	B	e4

※Please contact VERTEX STANDARD.

MAIN Unit

REF	DESCRIPTION	VALUE	V/W	TOL.	MFR'S DESIG	VXSTD P/N	VERS.	LOT	SIDE	LAY ADR
Q 1108	TRANSISTOR				2SA1774 TL R	G3117748R		1-	A	C4
Q 1109	IC				MB15A02PFV1-G-BND-EF	G1092541		1-	A	C4
Q 1110	TRANSISTOR				DTC144EE TL	G3070075		1-	A	D4
Q 1111	TRANSISTOR				2SA1774 TL R	G3117748R		1-	A	D5
Q 1112	IC				MB15A02PFV1-G-BND-EF	G1092541		1-	A	D5
Q 1113	TRANSISTOR				2SC4617 TL R	G3346178R		1-	B	d4
Q 1114	TRANSISTOR				DTC144EE TL	G3070075		1-	B	e4
Q 1115	TRANSISTOR				DTC144EE TL	G3070075		1-	B	e4
Q 1116	TRANSISTOR				2SC5006-T1	G3350068		1-	B	d4
Q 1117	TRANSISTOR				2SC5006-T1	G3350068		1-	B	d4
Q 1118	TRANSISTOR				2SC5006-T1	G3350068		1-	A	C4
Q 1119	TRANSISTOR				2SC5006-T1	G3350068		1-	A	C4
Q 1120	TRANSISTOR				2SC5374-TL	G3353748		1-	B	d4
Q 1121	TRANSISTOR				2SC5374-TL	G3353748		1-	B	d4
Q 1122	TRANSISTOR				2SC5374-TL	G3353748		1-	A	D4
Q 1123	TRANSISTOR				2SC5006-T1	G3350068		1-	B	c5
Q 1124	TRANSISTOR				2SC5006-T1	G3350068		1-	B	b5
Q 1125	TRANSISTOR				2SC5374-TL	G3353748		1-	A	E5
Q 1126	TRANSISTOR				2SC5374-TL	G3353748		1-	B	c4
Q 1127	TRANSISTOR				2SC5374-TL	G3353748		1-	B	b4
Q 1128	TRANSISTOR				2SC5374-TL	G3353748		1-	A	E5
Q 1129	IC				NJM2904V-TE1	G1091677		1-	B	e3
Q 1130	TRANSISTOR				DTA144EE TL	G3070074		1-	B	e3
Q 1131	TRANSISTOR				DTC144EE TL	G3070075		1-	B	e3
Q 1132	FET				2SK2596BXTL	G3825967		1-	A	C3
Q 1133	TRANSISTOR				2SD1664 T100 Q	G3416647Q		1-	B	d3
Q 1134	FET				2SK2975-T11	G3829757		1-	A	C3
Q 1135	FET				RD70HVF1	G3090140		1-	A	D1
R 1001	CHIP RES.	15k	1/16W	0.5%	RR0510R-153-D	J24189147		1-	A	E3
R 1002	CHIP RES.	100k	1/16W	5%	RMC1/16S 104JTH	J24189049		1-	B	b3
R 1003	CHIP RES.	100	1/16W	5%	RMC1/16S 101JTH	J24189013		1-	B	c3
R 1004	CHIP RES.	0	1/16W	5%	RMC1/16S JPTH	J24189070		1-	B	c3
R 1005	CHIP RES.	4.7k	1/16W	5%	RMC1/16S 472JTH	J24189033		1-	B	c3
R 1006	CHIP RES.	100	1/16W	5%	RMC1/16S 101JTH	J24189013		1-	B	c3
R 1007	CHIP RES.	100k	1/16W	5%	RMC1/16S 104JTH	J24189049		1-	B	c3
R 1008	CHIP RES.	100k	1/16W	5%	RMC1/16S 104JTH	J24189049		1-	B	c3
R 1009	CHIP RES.	100k	1/16W	5%	RMC1/16S 104JTH	J24189049		1-	B	c3
R 1010	CHIP RES.	33k	1/16W	5%	RMC1/16S 333JTH	J24189043		1-	B	c3
R 1011	CHIP RES.	220k	1/16W	5%	RMC1/16S 224JTH	J24189053		1-	B	c3
R 1012	CHIP RES.	100	1/16W	5%	RMC1/16S 101JTH	J24189013		1-	B	c3
R 1013	CHIP RES.	1k	1/16W	5%	RMC1/16S 102JTH	J24189025		1-	B	c3
R 1014	CHIP RES.	100	1/16W	5%	RMC1/16S 101JTH	J24189013		1-	B	c3
R 1015	CHIP RES.	0	1/16W	5%	RMC1/16S JPTH	J24189070		1-	A	E3
R 1016	CHIP RES.	4.7k	1/16W	5%	RMC1/16S 472JTH	J24189033		1-	A	D3
R 1017	CHIP RES.	100	1/16W	5%	RMC1/16S 101JTH	J24189013		1-	A	E3
R 1018	CHIP RES.	47k	1/16W	5%	RMC1/16S 473JTH	J24189045		1-	A	D3
R 1019	CHIP RES.	1M	1/16W	5%	RMC1/16S 105JTH	J24189061		1-	A	D3
R 1020	CHIP RES.	1k	1/16W	5%	RMC1/16S 102JTH	J24189025		1-	A	D3
R 1021	CHIP RES.	1k	1/16W	5%	RMC1/16S 102JTH	J24189025		1-	B	c3
R 1022	CHIP RES.	47k	1/16W	5%	RMC1/16S 473JTH	J24189045		1-	B	c3
R 1023	CHIP RES.	220k	1/16W	5%	RMC1/16S 224JTH	J24189053		1-	B	c3
R 1025	CHIP RES.	10k	1/16W	0.5%	RR0510P-103-D	J24189143		1-	B	b3
R 1026	CHIP RES.	47k	1/16W	5%	RMC1/16S 473JTH	J24189045		1-	B	b3
R 1027	CHIP RES.	100k	1/16W	0.5%	RR0510R-104-D	J24189167		1-	A	E3
R 1028	CHIP RES.	82k	1/16W	0.5%	RR0510R-823-D	J24189165		1-	A	E3
R 1030	CHIP RES.	100k	1/16W	5%	RMC1/16S 104JTH	J24189049		1-	B	b3
R 1031	CHIP RES.	100	1/16W	5%	RMC1/16S 101JTH	J24189013		1-	B	b3
R 1032	CHIP RES.	0	1/16W	5%	RMC1/16S JPTH	J24189070		1-	B	b3
R 1033	CHIP RES.	4.7k	1/16W	5%	RMC1/16S 472JTH	J24189033		1-	B	b4
R 1034	CHIP RES.	100	1/16W	5%	RMC1/16S 101JTH	J24189013		1-	B	b4
R 1035	CHIP RES.	100	1/16W	5%	RMC1/16S 101JTH	J24189013		1-	B	b5
R 1036	CHIP RES.	100k	1/16W	5%	RMC1/16S 104JTH	J24189049		1-	B	b4
R 1037	CHIP RES.	100k	1/16W	5%	RMC1/16S 104JTH	J24189049		1-	B	b4
R 1038	CHIP RES.	100k	1/16W	5%	RMC1/16S 104JTH	J24189049		1-	B	b4
R 1039	CHIP RES.	33k	1/16W	5%	RMC1/16S 333JTH	J24189043		1-	B	b5
R 1040	CHIP RES.	220k	1/16W	5%	RMC1/16S 224JTH	J24189053		1-	B	b5
R 1041	CHIP RES.	150	1/16W	5%	RMC1/16S 151JTH	J24189015		1-	B	b5
R 1042	CHIP RES.	1k	1/16W	5%	RMC1/16S 102JTH	J24189025		1-	B	b5
R 1045	CHIP RES.	0	1/16W	5%	RMC1/16S JPTH	J24189070		1-	B	b4
R 1046	CHIP RES.	4.7k	1/16W	5%	RMC1/16S 472JTH	J24189033		1-	B	b4
R 1047	CHIP RES.	100	1/16W	5%	RMC1/16S 101JTH	J24189013		1-	B	b4
R 1048	CHIP RES.	47k	1/16W	5%	RMC1/16S 473JTH	J24189045		1-	B	b5
R 1049	CHIP RES.	1M	1/16W	5%	RMC1/16S 105JTH	J24189061		1-	B	b5
R 1050	CHIP RES.	2.2k	1/16W	5%	RMC1/16S 222JTH	J24189029		1-	B	b5
R 1051	CHIP RES.	1.2k	1/16W	5%	RMC1/16S 122JTH	J24189026		1-	B	b5
R 1052	CHIP RES.	47k	1/16W	5%	RMC1/16S 473JTH	J24189045		1-	B	b5
R 1053	CHIP RES.	220k	1/16W	5%	RMC1/16S 224JTH	J24189053		1-	B	b5

REF	DESCRIPTION	VALUE	V/W	TOL.	MFR'S DESIG	VXSTD P/N	VERS.	LOT	SIDE	LAY ADR
R 1057	CHIP RES.	82k	1/16W	0.5%	RR0510R-823-D	J24189165		1-	A	E3
R 1059	CHIP RES.	10k	1/16W	5%	RMC1/16S 103JTH	J24189037		1-	B	b3
R 1060	CHIP RES.	47	1/16W	5%	RMC1/16S 470JTH	J24189009		1-	B	b3
R 1061	CHIP RES.	47k	1/16W	5%	RMC1/16S 473JTH	J24189045		1-	B	b3
R 1062	CHIP RES.	10k	1/16W	5%	RMC1/16S 103JTH	J24189037		1-	B	b3
R 1063	CHIP RES.	47	1/16W	5%	RMC1/16S 470JTH	J24189009		1-	B	b3
R 1064	CHIP RES.	47	1/16W	5%	RMC1/16S 470JTH	J24189009		1-	B	b3
R 1065	CHIP RES.	680	1/16W	5%	RMC1/16S 681JTH	J24189023		1-	B	b3
R 1066	CHIP RES.	100	1/16W	5%	RMC1/16S 101JTH	J24189013		1-	B	b4
R 1067	CHIP RES.	220k	1/16W	5%	RMC1/16S 224JTH	J24189053		1-	B	c4
R 1068	CHIP RES.	220k	1/16W	5%	RMC1/16S 224JTH	J24189053		1-	B	c4
R 1069	CHIP RES.	220k	1/16W	5%	RMC1/16S 224JTH	J24189053		1-	B	c4
R 1070	CHIP RES.	15k	1/16W	5%	RMC1/16S 153JTH	J24189039		1-	B	c4
R 1071	CHIP RES.	120k	1/16W	5%	RMC1/16S 124JTH	J24189050		1-	B	c4
R 1072	CHIP RES.	47k	1/16W	5%	RMC1/16S 473JTH	J24189045		1-	B	c4
R 1073	CHIP RES.	220k	1/16W	5%	RMC1/16S 224JTH	J24189053		1-	B	c4
R 1074	CHIP RES.	150	1/16W	5%	RMC1/16S 151JTH	J24189015		1-	B	c3
R 1075	CHIP RES.	470	1/16W	5%	RMC1/16S 471JTH	J24189021		1-	B	c4
R 1076	CHIP RES.	47	1/16W	5%	RMC1/16S 470JTH	J24189009		1-	B	b3
R 1077	CHIP RES.	680	1/16W	5%	RMC1/16S 681JTH	J24189023		1-	B	b4
R 1078	CHIP RES.	100	1/16W	5%	RMC1/16S 101JTH	J24189013		1-	B	b4
R 1079	CHIP RES.	220k	1/16W	5%	RMC1/16S 224JTH	J24189053		1-	B	a4
R 1080	CHIP RES.	220k	1/16W	5%	RMC1/16S 224JTH	J24189053		1-	B	a4
R 1081	CHIP RES.	220k	1/16W	5%	RMC1/16S 224JTH	J24189053		1-	B	a4
R 1082	CHIP RES.	15k	1/16W	5%	RMC1/16S 153JTH	J24189039		1-	B	a5
R 1083	CHIP RES.	120k	1/16W	5%	RMC1/16S 124JTH	J24189050		1-	B	a5
R 1084	CHIP RES.	47k	1/16W	5%	RMC1/16S 473JTH	J24189045		1-	B	a5
R 1085	CHIP RES.	220k	1/16W	5%	RMC1/16S 224JTH	J24189053		1-	B	a5
R 1086	CHIP RES.	150	1/16W	5%	RMC1/16S 151JTH	J24189015		1-	B	b5
R 1087	CHIP RES.	470	1/16W	5%	RMC1/16S 471JTH	J24189021		1-	B	a5
R 1088	CHIP RES.	10k	1/16W	0.5%	RR0510P-103-D	J24189143		1-	B	b3
R 1089	CHIP RES.	47k	1/16W	5%	RMC1/16S 473JTH	J24189045		1-	B	b3
R 1091	CHIP RES.	10k	1/16W	5%	RMC1/16S 103JTH	J24189037		1-	B	b3
R 1092	CHIP RES.	47	1/16W	5%	RMC1/16S 470JTH	J24189009		1-	B	b3
R 1093	CHIP RES.	10k	1/16W	5%	RMC1/16S 103JTH	J24189037		1-	B	a3
R 1094	CHIP RES.	47	1/16W	5%	RMC1/16S 470JTH	J24189009		1-	B	b3
R 1095	CHIP RES.	47	1/16W	5%	RMC1/16S 470JTH	J24189009		1-	B	b3
R 1096	CHIP RES.	330	1/16W	5%	RMC1/16S 331JTH	J24189019		1-	B	b4
R 1097	CHIP RES.	100	1/16W	5%	RMC1/16S 101JTH	J24189013		1-	B	b4
R 1098	CHIP RES.	47k	1/16W	5%	RMC1/16S 473JTH	J24189045		1-	A	E4
R 1100	CHIP RES.	1.5M	1/16W	5%	RMC1/16S 155JTH	J24189063		1-	B	c4
R 1101	CHIP RES.	47	1/16W	5%	RMC1/16S 470JTH	J24189009		1-	B	a3
R 1102	CHIP RES.	330	1/16W	5%	RMC1/16S 331JTH	J24189019		1-	A	F4
R 1103	CHIP RES.	100	1/16W	5%	RMC1/16S 101JTH	J24189013		1-	A	F4
R 1104	CHIP RES.	47k	1/16W	5%	RMC1/16S 473JTH	J24189045		1-	A	F4
R 1106	CHIP RES.	1M	1/16W	5%	RMC1/16S 105JTH	J24189061		1-	A	F4
R 1107	CHIP RES.	4.7k	1/16W	5%	RMC1/16S 472JTH	J24189033		1-	A	F4
R 1108	CHIP RES.	470	1/16W	5%	RMC1/16S 471JTH	J24189021		1-	A	F5
R 1109	CHIP RES.	470	1/16W	5%	RMC1/16S 471JTH	J24189021		1-	B	c4
R 1110	CHIP RES.	4.7k	1/16W	5%	RMC1/16S 472JTH	J24189033		1-	B	c4
R 1111	CHIP RES.	47k	1/16W	5%	RMC1/16S 473JTH	J24189045		1-	A	D4
R 1112	CHIP RES.	100	1/16W	5%	RMC1/16S 101JTH	J24189013		1-	A	D4
R 1113	CHIP RES.	47	1/16W	5%	RMC1/16S 470JTH	J24189009		1-	B	b2
R 1114	CHIP RES.	330k	1/16W	5%	RMC1/16S 334JTH	J24189055		1-	A	F4
R 1115	CHIP RES.	22	1/16W	5%	RMC1/16S 220JTH	J24189005		1-	A	F4
R 1116	CHIP RES.	100	1/16W	5%	RMC1/16S 101JTH	J24189013		1-	A	F4
R 1117	CHIP RES.	100	1/16W	5%	RMC1/16S 101JTH	J24189013		1-	A	F4
R 1118	CHIP RES.	100	1/16W	5%	RMC1/16S 101JTH	J24189013		1-	A	F4
R 1119	CHIP RES.	820k	1/16W	5%	RMC1/16S 824JTH	J24189060		1-	A	F4
R 1120	CHIP RES.	820k	1/16W	5%	RMC1/16S 824JTH	J24189060		1-	A	F4
R 1121	CHIP RES.	100	1/16W	5%	RMC1/16S 101JTH	J24189013		1-	A	E4
R 1122	CHIP RES.	100	1/16W	5%	RMC1/16S 101JTH	J24189013		1-	A	E4
R 1123	CHIP RES.	82	1/16W	5%	RMC1/16S 820JTH	J24189012		1-	B	b4
R 1124	CHIP RES.	100	1/16W	5%	RMC1/16S 101JTH	J24189013		1-	A	E4
R 1125	CHIP RES.	1.5M	1/16W	5%	RMC1/16S 155JTH	J24189063		1-	A	D4
R 1126	CHIP RES.	1.5M	1/16W	5%	RMC1/16S 155JTH	J24189063		1-	A	E4
R 1127	CHIP RES.	1k	1/16W	5%	RMC1/16S 102JTH	J24189025		1-	A	D4
R 1128	CHIP RES.	100	1/16W	5%	RMC1/16S 101JTH	J24189013		1-	A	D4
R 1129	CHIP RES.	1k	1/16W	5%	RMC1/16S 102JTH	J24189025		1-	A	E4
R 1130	CHIP RES.	1k	1/16W	5%	RMC1/16S 102JTH	J24189025		1-	A	E4
R 1131	CHIP RES.	47k	1/16W	5%	RMC1/16S 473JTH	J24189045		1-	A	E4
R 1132	CHIP RES.	22	1/16W	5%	RMC1/16S 220JTH	J24189005		1-	A	D3
R 1133	CHIP RES.	2.2k	1/16W	5%	RMC1/16S 222JTH	J24189029		1-	B	d4
R 1134	CHIP RES.	100	1/16W	5%	RMC1/16S 101JTH	J24189013		1-	B	e3
R 1135	CHIP RES.	0	1/16W	5%	RMC1/16S JPTH	J24189070		1-	B	d3
R 1136	CHIP RES.	560	1/16W	5%	RMC1/16S 561JTH	J24189022		1-	A	C4
R 1137	CHIP RES.	330k	1/16W	5%	RMC1/16S 334JTH	J24189055		1-	A	C4

MAIN Unit

REF	DESCRIPTION	VALUE	V/W	TOL.	MFR'S DESIG	VXSTD P/N	VERS.	LOT	SIDE	LAY ADR
R 1138	CHIP RES.	8.2k	1/16W	0.5%	RR0510P-822-D	J24189141		1-	A	C4
R 1139	CHIP RES.	330	1/16W	5%	RMC1/16S 331JTH	J24189019		1-	A	C4
R 1140	CHIP RES.	220	1/16W	5%	RMC1/16S 221JTH	J24189017		1-	A	C4
R 1141	CHIP RES.	100	1/16W	5%	RMC1/16S 101JTH	J24189013		1-	A	B4
R 1142	CHIP RES.	470	1/16W	5%	RMC1/16S 471JTH	J24189021		1-	A	B4
R 1143	CHIP RES.	10	1/16W	5%	RMC1/16S 100JTH	J24189001		1-	A	B4
R 1145	CHIP RES.	100	1/16W	5%	RMC1/16S 101JTH	J24189013		1-	B	f4
R 1146	CHIP RES.	150k	1/16W	5%	RMC1/16S 154JTH	J24189051		1-	B	e3
R 1147	CHIP RES.	100k	1/16W	5%	RMC1/16S 104JTH	J24189049		1-	B	f4
R 1148	CHIP RES.	22k	1/16W	5%	RMC1/16S 223JTH	J24189041		1-	A	B4
R 1149	CHIP RES.	10k	1/16W	0.5%	RR0510P-103-D	J24189143		1-	A	B4
R 1150	CHIP RES.	390k	1/16W	5%	RMC1/16S 394JTH	J24189056		1-	A	B4
R 1151	CHIP RES.	1k	1/16W	5%	RMC1/16S 102JTH	J24189025		1-	A	B4
R 1152	CHIP RES.	4.7k	1/16W	5%	RMC1/16S 472JTH	J24189033		1-	A	B4
R 1153	CHIP RES.	330k	1/16W	5%	RMC1/16S 334JTH	J24189055		1-	B	f4
R 1154	CHIP RES.	47k	1/16W	5%	RMC1/16S 473JTH	J24189045		1-	B	f4
R 1155	CHIP RES.	4.7k	1/16W	5%	RMC1/16S 472JTH	J24189033		1-	B	f3
R 1156	CHIP RES.	1M	1/16W	5%	RMC1/16S 105JTH	J24189061		1-	B	f3
R 1157	CHIP RES.	470	1/16W	5%	RMC1/16S 471JTH	J24189021		1-	B	f3
R 1158	CHIP RES.	4.7k	1/16W	5%	RMC1/16S 472JTH	J24189033		1-	B	f3
R 1159	CHIP RES.	1M	1/16W	5%	RMC1/16S 105JTH	J24189061		1-	B	f3
R 1160	CHIP RES.	470	1/16W	5%	RMC1/16S 471JTH	J24189021		1-	B	e3
R 1161	CHIP RES.	1k	1/16W	5%	RMC1/16S 102JTH	J24189025		1-	B	e3
R 1162	CHIP RES.	4.7k	1/16W	5%	RMC1/16S 472JTH	J24189033		1-	B	e3
R 1163	CHIP RES.	1k	1/16W	5%	RMC1/16S 102JTH	J24189025		1-	B	e3
R 1164	CHIP RES.	100k	1/16W	5%	RMC1/16S 104JTH	J24189049		1-	A	B4
R 1166	CHIP RES.	2.2k	1/16W	5%	RMC1/16S 222JTH	J24189029		1-	A	E5
R 1167	CHIP RES.	100	1/16W	5%	RMC1/16S 101JTH	J24189013		1-	A	E5
R 1168	CHIP RES.	100	1/16W	5%	RMC1/16S 101JTH	J24189013		1-	A	E5
R 1169	CHIP RES.	560	1/16W	5%	RMC1/16S 561JTH	J24189022		1-	A	E5
R 1170	CHIP RES.	330k	1/16W	5%	RMC1/16S 334JTH	J24189055		1-	A	E5
R 1171	CHIP RES.	8.2k	1/16W	0.5%	RR0510P-822-D	J24189141		1-	A	E5
R 1172	CHIP RES.	330	1/16W	5%	RMC1/16S 331JTH	J24189019		1-	A	E5
R 1173	CHIP RES.	220	1/16W	5%	RMC1/16S 221JTH	J24189017		1-	A	D5
R 1174	CHIP RES.	470	1/16W	5%	RMC1/16S 471JTH	J24189021		1-	A	D5
R 1175	CHIP RES.	100	1/16W	5%	RMC1/16S 101JTH	J24189013		1-	A	D5
R 1176	CHIP RES.	10	1/16W	5%	RMC1/16S 100JTH	J24189001		1-	A	D5
R 1177	CHIP RES.	100	1/16W	5%	RMC1/16S 101JTH	J24189013		1-	B	d5
R 1178	CHIP RES.	150k	1/16W	5%	RMC1/16S 154JTH	J24189051		1-	B	d5
R 1179	CHIP RES.	10k	1/16W	0.5%	RR0510P-103-D	J24189143		1-	B	c5
R 1180	CHIP RES.	100k	1/16W	5%	RMC1/16S 104JTH	J24189049		1-	B	d5
R 1181	CHIP RES.	22k	1/16W	5%	RMC1/16S 223JTH	J24189041		1-	B	d5
R 1182	CHIP RES.	390k	1/16W	5%	RMC1/16S 394JTH	J24189056		1-	B	d5
R 1183	CHIP RES.	1k	1/16W	5%	RMC1/16S 102JTH	J24189025		1-	B	d5
R 1184	CHIP RES.	4.7k	1/16W	5%	RMC1/16S 472JTH	J24189033		1-	B	d5
R 1185	CHIP RES.	330k	1/16W	5%	RMC1/16S 334JTH	J24189055		1-	A	C5
R 1186	CHIP RES.	47k	1/16W	5%	RMC1/16S 473JTH	J24189045		1-	B	d5
R 1187	CHIP RES.	4.7k	1/16W	5%	RMC1/16S 472JTH	J24189033		1-	A	C5
R 1188	CHIP RES.	1M	1/16W	5%	RMC1/16S 105JTH	J24189061		1-	A	C5
R 1189	CHIP RES.	470	1/16W	5%	RMC1/16S 471JTH	J24189021		1-	A	C5
R 1190	CHIP RES.	4.7k	1/16W	5%	RMC1/16S 472JTH	J24189033		1-	A	C5
R 1191	CHIP RES.	1M	1/16W	5%	RMC1/16S 105JTH	J24189061		1-	A	C5
R 1192	CHIP RES.	470	1/16W	5%	RMC1/16S 471JTH	J24189021		1-	A	C5
R 1193	CHIP RES.	1k	1/16W	5%	RMC1/16S 102JTH	J24189025		1-	B	d5
R 1194	CHIP RES.	4.7k	1/16W	5%	RMC1/16S 472JTH	J24189033		1-	B	d5
R 1195	CHIP RES.	1k	1/16W	5%	RMC1/16S 102JTH	J24189025		1-	A	B4
R 1196	CHIP RES.	100k	1/16W	5%	RMC1/16S 104JTH	J24189049		1-	A	C5
R 1197	CHIP RES.	1M	1/16W	5%	RMC1/16S 105JTH	J24189061		1-	B	e4
R 1198	CHIP RES.	470k	1/16W	5%	RMC1/16S 474JTH	J24189057		1-	B	e4
R 1199	CHIP RES.	1k	1/16W	5%	RMC1/16S 102JTH	J24189025		1-	A	D5
R 1200	CHIP RES.	1M	1/16W	5%	RMC1/16S 105JTH	J24189061		1-	A	D5
R 1201	CHIP RES.	470k	1/16W	5%	RMC1/16S 474JTH	J24189057		1-	A	D5
R 1202	CHIP RES.	100k	1/16W	5%	RMC1/16S 104JTH	J24189049		1-	B	b5
R 1203	CHIP RES.	10k	1/16W	5%	RMC1/16S 103JTH	J24189037		1-	B	e5
R 1204	CHIP RES.	100k	1/16W	5%	RMC1/16S 104JTH	J24189049		1-	B	b5
R 1205	CHIP RES.	10k	1/16W	5%	RMC1/16S 103JTH	J24189037		1-	B	e5
R 1206	CHIP RES.	2.7k	1/16W	5%	RMC1/16S 272JTH	J24189030		1-	B	e4
R 1207	CHIP RES.	100k	1/16W	5%	RMC1/16S 104JTH	J24189049		1-	A	B4
R 1208	CHIP RES.	3.3k	1/16W	5%	RMC1/16S 332JTH	J24189031		1-	B	e4
R 1209	CHIP RES.	1k	1/16W	5%	RMC1/16S 102JTH	J24189025		1-	A	B4
R 1210	CHIP RES.	100k	1/16W	5%	RMC1/16S 104JTH	J24189049		1-	A	B4
R 1211	CHIP RES.	10k	1/16W	5%	RMC1/16S 103JTH	J24189037		1-	B	f4
R 1212	CHIP RES.	470k	1/16W	5%	RMC1/16S 474JTH	J24189057		1-	B	f4
R 1213	CHIP RES.	330k	1/16W	5%	RMC1/16S 334JTH	J24189055		1-	B	f4
R 1214	CHIP RES.	33k	1/16W	0.5%	RR0510R-333-D	J24189155		1-	B	e4
R 1215	CHIP RES.	2.7k	1/16W	0.5%	RR0510P-272-D	J24189129		1-	B	e4
R 1216	CHIP RES.	3.3k	1/16W	0.5%	RR0510P-332-D	J24189131		1-	B	e4

REF	DESCRIPTION	VALUE	V/W	TOL.	MFR'S DESIG	VXSTD P/N	VERS.	LOT	SIDE	LAY ADR
R 1217	CHIP RES.	100k	1/16W	5%	RMC1/16S 104JTH	J24189049		1-	B	e3
R 1218	CHIP RES.	150k	1/16W	5%	RMC1/16S 154JTH	J24189051		1-	B	e4
R 1219	CHIP RES.	47	1/16W	5%	RMC1/16S 470JTH	J24189009		1-	A	B4
R 1220	CHIP RES.	4.7k	1/16W	5%	RMC1/16S 472JTH	J24189033		1-	B	e3
R 1221	CHIP RES.	220	1/16W	5%	RMC1/16S 221JTH	J24189017		1-	B	e4
R 1222	CHIP RES.	22k	1/16W	5%	RMC1/16S 223JTH	J24189041		1-	B	e4
R 1223	CHIP RES.	22k	1/16W	5%	RMC1/16S 223JTH	J24189041		1-	B	e3
R 1224	CHIP RES.	22k	1/16W	5%	RMC1/16S 223JTH	J24189041		1-	B	e3
R 1225	CHIP RES.	22k	1/16W	5%	RMC1/16S 223JTH	J24189041		1-	B	e3
R 1226	CHIP RES.	22k	1/16W	5%	RMC1/16S 223JTH	J24189041		1-	B	e3
R 1227	CHIP RES.	22k	1/16W	5%	RMC1/16S 223JTH	J24189041		1-	B	e3
R 1228	CHIP RES.	2.7k	1/16W	0.5%	RR0510P-272-D	J24189129		1-	B	d5
R 1229	CHIP RES.	1k	1/16W	5%	RMC1/16S 102JTH	J24189025		1-	A	D5
R 1230	CHIP RES.	3.3k	1/16W	0.5%	RR0510P-332-D	J24189131		1-	B	d5
R 1231	CHIP RES.	100k	1/16W	5%	RMC1/16S 104JTH	J24189049		1-	A	D5
R 1232	CHIP RES.	68k	1/16W	5%	RMC1/16S 683JTH	J24189047		1-	B	f4
R 1233	CHIP RES.	100k	1/16W	5%	RMC1/16S 104JTH	J24189049		1-	A	B5
R 1234	CHIP RES.	33k	1/16W	0.5%	RR0510R-333-D	J24189155		1-	B	d5
R 1235	CHIP RES.	2.7k	1/16W	0.5%	RR0510P-272-D	J24189129		1-	B	d5
R 1236	CHIP RES.	3.3k	1/16W	0.5%	RR0510P-332-D	J24189131		1-	B	d5
R 1237	CHIP RES.	100k	1/16W	5%	RMC1/16S 104JTH	J24189049		1-	B	d5
R 1238	CHIP RES.	150k	1/16W	5%	RMC1/16S 154JTH	J24189051		1-	B	d5
R 1239	CHIP RES.	220	1/16W	5%	RMC1/16S 221JTH	J24189017		1-	A	D5
R 1240	CHIP RES.	47	1/16W	5%	RMC1/16S 470JTH	J24189009		1-	A	C5
R 1241	CHIP RES.	4.7k	1/16W	5%	RMC1/16S 472JTH	J24189033		1-	B	d5
R 1242	CHIP RES.	22k	1/16W	5%	RMC1/16S 223JTH	J24189041		1-	B	d5
R 1243	CHIP RES.	22k	1/16W	5%	RMC1/16S 223JTH	J24189041		1-	B	d5
R 1244	CHIP RES.	22k	1/16W	5%	RMC1/16S 223JTH	J24189041		1-	B	c5
R 1245	CHIP RES.	22k	1/16W	5%	RMC1/16S 223JTH	J24189041		1-	B	d5
R 1246	CHIP RES.	22k	1/16W	5%	RMC1/16S 223JTH	J24189041		1-	B	d5
R 1247	CHIP RES.	1k	1/16W	5%	RMC1/16S 102JTH	J24189025		1-	B	c5
R 1248	CHIP RES.	22k	1/16W	5%	RMC1/16S 223JTH	J24189041		1-	B	c5
R 1249	CHIP RES.	68k	1/16W	5%	RMC1/16S 683JTH	J24189047		1-	B	f4
R 1250	CHIP RES.	330k	1/16W	5%	RMC1/16S 334JTH	J24189055		1-	B	f4
R 1251	CHIP RES.	470k	1/16W	5%	RMC1/16S 474JTH	J24189057		1-	B	f4
R 1252	CHIP RES.	47k	1/16W	5%	RMC1/16S 473JTH	J24189045		1-	A	A4
R 1253	CHIP RES.	68k	1/16W	0.5%	RR0510R-683-D	J24189163		1-	B	f4
R 1254	CHIP RES.	56k	1/16W	5%	RMC1/16S 563JTH	J24189046		1-	A	A4
R 1255	CHIP RES.	220k	1/16W	5%	RMC1/16S 224JTH	J24189053		1-	A	A4
R 1256	CHIP RES.	10k	1/16W	5%	RMC1/16S 103JTH	J24189037		1-	A	A4
R 1257	CHIP RES.	1k	1/16W	5%	RMC1/16S 102JTH	J24189025		1-	B	f4
R 1258	CHIP RES.	27k	1/16W	5%	RMC1/16S 273JTH	J24189042		1-	B	f4
R 1259	CHIP RES.	390k	1/16W	5%	RMC1/16S 394JTH	J24189056		1-	B	f4
R 1260	CHIP RES.	150k	1/16W	5%	RMC1/16S 154JTH	J24189051		1-	A	A4
R 1261	CHIP RES.	100k	1/16W	5%	RMC1/16S 104JTH	J24189049		1-	B	f4
R 1262	CHIP RES.	4.7k	1/16W	5%	RMC1/16S 472JTH	J24189033		1-	A	A3
R 1263	CHIP RES.	10k	1/16W	5%	RMC1/16S 103JTH	J24189037		1-	B	f4
R 1264	CHIP RES.	330k	1/16W	5%	RMC1/16S 334JTH	J24189055		1-	B	f4
R 1265	CHIP RES.	330k	1/16W	5%	RMC1/16S 334JTH	J24189055		1-	B	f4
R 1266	CHIP RES.	68k	1/16W	0.5%	RR0510R-683-D	J24189163		1-	B	f4
R 1267	CHIP RES.	56k	1/16W	5%	RMC1/16S 563JTH	J24189046		1-	B	f4
R 1268	CHIP RES.	220k	1/16W	5%	RMC1/16S 224JTH	J24189053		1-	B	f4
R 1269	CHIP RES.	10k	1/16W	5%	RMC1/16S 103JTH	J24189037		1-	B	f4
R 1270	CHIP RES.	1k	1/16W	5%	RMC1/16S 102JTH	J24189025		1-	B	f4
R 1271	CHIP RES.	27k	1/16W	5%	RMC1/16S 273JTH	J24189042		1-	B	f4
R 1272	CHIP RES.	390k	1/16W	5%	RMC1/16S 394JTH	J24189056		1-	B	f4
R 1273	CHIP RES.	4.7k	1/16W	5%	RMC1/16S 472JTH	J24189033		1-	A	A3
R 1274	CHIP RES.	150k	1/16W	5%	RMC1/16S 154JTH	J24189051		1-	B	f4
R 1275	CHIP RES.	100k	1/16W	5%	RMC1/16S 104JTH	J24189049		1-	B	f4
R 1276	CHIP RES.	10k	1/16W	5%	RMC1/16S 103JTH	J24189037		1-	A	B3
R 1277	CHIP RES.	10k	1/16W	5%	RMC1/16S 103JTH	J24189037		1-	A	B3
R 1278	CHIP RES.	220k	1/16W	5%	RMC1/16S 224JTH	J24189053		1-	A	B3
R 1279	CHIP RES.	220k	1/16W	5%	RMC1/16S 224JTH	J24189053		1-	A	B3
R 1280	CHIP RES.	220k	1/16W	5%	RMC1/16S 224JTH	J24189053		1-	A	B3
R 1281	CHIP RES.	4.7k	1/16W	5%	RMC1/16S 472JTH	J24189033		1-	A	A1
R 1282	CHIP RES.	220	1/16W	5%	RMC1/16S 221JTH	J24189017		1-	A	A1
R 1283	CHIP RES.	4.7k	1/16W	5%	RMC1/16S 472JTH	J24189033		1-	A	A3
R 1284	CHIP RES.	220k	1/16W	5%	RMC1/16S 224JTH	J24189053		1-	A	A3
R 1285	CHIP RES.	220k	1/16W	5%	RMC1/16S 224JTH	J24189053		1-	A	A3
R 1286	CHIP RES.	220k	1/16W	5%	RMC1/16S 224JTH	J24189053		1-	A	B3
R 1287	CHIP RES.	1k	1/16W	5%	RMC1/16S 102JTH	J24189025		1-	A	A3
R 1288	CHIP RES.	1k	1/16W	5%	RMC1/16S 102JTH	J24189025		1-	A	A3
R 1289	CHIP RES.	10k	1/16W	5%	RMC1/16S 103JTH	J24189037		1-	B	f4
R 1290	CHIP RES.	10k	1/16W	5%	RMC1/16S 103JTH	J24189037		1-	A	B3
R 1291	CHIP RES.	22k	1/16W	5%	RMC1/16S 223JTH	J24189041		1-	A	B3
R 1292	CHIP RES.	390k	1/16W	5%	RMC1/16S 394JTH	J24189056		1-	A	A4
R 1293	CHIP RES.	390k	1/16W	5%	RMC1/16S 394JTH	J24189056		1-	A	A4

MAIN Unit

REF	DESCRIPTION	VALUE	V/W	TOL.	MFR'S DESIG	VXSTD P/N	VERS.	LOT	SIDE	LAY ADR
R 1294	CHIP RES.	47k	1/16W	5%	RMC1/16S 473JTH	J24189045		1-	A	A4
R 1295	CHIP RES.	390k	1/16W	5%	RMC1/16S 394JTH	J24189056		1-	A	A4
R 1296	CHIP RES.	390k	1/16W	5%	RMC1/16S 394JTH	J24189056		1-	A	A4
R 1297	CHIP RES.	68k	1/16W	5%	RMC1/16S 683JTH	J24189047		1-	A	A4
R 1298	CHIP RES.	68k	1/16W	5%	RMC1/16S 683JTH	J24189047		1-	A	A4
R 1299	CHIP RES.	390k	1/16W	5%	RMC1/16S 394JTH	J24189056		1-	B	g4
R 1300	CHIP RES.	390k	1/16W	5%	RMC1/16S 394JTH	J24189056		1-	B	g4
R 1301	CHIP RES.	47k	1/16W	5%	RMC1/16S 473JTH	J24189045		1-	B	g4
R 1302	CHIP RES.	390k	1/16W	5%	RMC1/16S 394JTH	J24189056		1-	B	g4
R 1303	CHIP RES.	390k	1/16W	5%	RMC1/16S 394JTH	J24189056		1-	B	f5
R 1304	CHIP RES.	68k	1/16W	5%	RMC1/16S 683JTH	J24189047		1-	B	f5
R 1305	CHIP RES.	68k	1/16W	5%	RMC1/16S 683JTH	J24189047		1-	B	f5
R 1306	CHIP RES.	270	1/16W	5%	RMC1/16S 271JTH	J24189018		1-	B	g1
R 1307	CHIP RES.	270	1/16W	5%	RMC1/16S 271JTH	J24189018		1-	B	f1
R 1308	CHIP RES.	270	1/16W	5%	RMC1/16S 271JTH	J24189018		1-	B	f1
R 1309	CHIP RES.	270	1/16W	5%	RMC1/16S 271JTH	J24189018		1-	B	f1
R 1310	CHIP RES.	4.7k	1/16W	5%	RMC1/16S 472JTH	J24189033		1-	B	g1
R 1311	CHIP RES.	100k	1/16W	5%	RMC1/16S 104JTH	J24189049		1-	B	f4
R 1312	CHIP RES.	100k	1/16W	5%	RMC1/16S 104JTH	J24189049		1-	B	f4
R 1313	CHIP RES.	47k	1/16W	5%	RMC1/16S 473JTH	J24189045		1-	B	f1
R 1314	CHIP RES.	10	1/16W	5%	RMC1/16S 100JTH	J24189001		1-	B	g2
R 1315	CHIP RES.	10	1/16W	5%	RMC1/16S 100JTH	J24189001		1-	B	g2
R 1316	CHIP RES.	100	1/16W	5%	RMC1/16S 101JTH	J24189013		1-	B	f2
R 1317	CHIP RES.	47	1/16W	5%	RMC1/16S 470JTH	J24189009		1-	A	A2
R 1318	CHIP RES.	100k	1/16W	5%	RMC1/16S 104JTH	J24189049		1-	B	f2
R 1319	CHIP RES.	100k	1/16W	5%	RMC1/16S 104JTH	J24189049		1-	B	f2
R 1320	CHIP RES.	100k	1/16W	5%	RMC1/16S 104JTH	J24189049		1-	B	f2
R 1321	CHIP RES.	100k	1/16W	5%	RMC1/16S 104JTH	J24189049		1-	A	A2
R 1322	CHIP RES.	100k	1/16W	5%	RMC1/16S 104JTH	J24189049		1-	A	A2
R 1323	CHIP RES.	100k	1/16W	5%	RMC1/16S 104JTH	J24189049		1-	B	f3
R 1324	CHIP RES.	2.2k	1/16W	5%	RMC1/16S 222JTH	J24189029		1-	B	f2
R 1325	CHIP RES.	12k	1/16W	5%	RMC1/16S 123JTH	J24189038		1-	B	f2
R 1326	CHIP RES.	12k	1/16W	5%	RMC1/16S 123JTH	J24189038		1-	B	f2
R 1327	CHIP RES.	4.7M	1/16W	5%	RMC1/16S 475JTH	J24189337		1-	B	f2
R 1328	CHIP RES.	10k	1/16W	5%	RMC1/16S 103JTH	J24189037		1-	B	f2
R 1329	CHIP RES.	12k	1/16W	5%	RMC1/16S 123JTH	J24189038		1-	B	f3
R 1330	CHIP RES.	1.5M	1/16W	5%	RMC1/16S 155JTH	J24189063		1-	B	f3
R 1331	CHIP RES.	100	1/16W	5%	RMC1/16S 101JTH	J24189013		1-	B	f3
R 1332	CHIP RES.	12k	1/16W	5%	RMC1/16S 123JTH	J24189038		1-	B	f3
R 1333	CHIP RES.	22k	1/16W	5%	RMC1/16S 223JTH	J24189041		1-	B	f3
R 1334	CHIP RES.	2.2k	1/16W	5%	RMC1/16S 222JTH	J24189029		1-	B	f2
R 1335	CHIP RES.	22k	1/16W	5%	RMC1/16S 223JTH	J24189041		1-	B	f5
R 1336	CHIP RES.	22k	1/16W	5%	RMC1/16S 223JTH	J24189041		1-	B	f3
R 1337	CHIP RES.	22	1/16W	5%	RMC1/16S 220JTH	J24189005		1-	B	f3
R 1338	CHIP RES.	22	1/16W	5%	RMC1/16S 220JTH	J24189005		1-	B	f3
R 1339	CHIP RES.	10	1/16W	5%	RMC1/16S 100JTH	J24189001		1-	A	B2
R 1340	CHIP RES.	10	1/16W	5%	RMC1/16S 100JTH	J24189001		1-	A	B2
R 1341	CHIP RES.	10	1/16W	5%	RMC1/16S 100JTH	J24189001		1-	A	B2
R 1342	CHIP RES.	1k	1/16W	5%	RMC1/16S 102JTH	J24189025		1-	A	B1
R 1343	CHIP RES.	100k	1/16W	5%	RMC1/16S 104JTH	J24189049		1-	A	A4
R 1344	CHIP RES.	2.2M	1/16W	5%	RMC1/16S 225JTH	J24189065		1-	A	A4
R 1345	CHIP RES.	27k	1/16W	5%	RMC1/16S 273JTH	J24189042		1-	A	B4
R 1346	CHIP RES.	47k	1/16W	5%	RMC1/16S 473JTH	J24189045		1-	B	e4
R 1347	CHIP RES.	220	1/16W	5%	RMC1/16S 221JTH	J24189017		1-	A	B4
R 1348	CHIP RES.	4.7k	1/16W	5%	RMC1/16S 472JTH	J24189033		1-	A	A1
R 1349	CHIP RES.	4.7k	1/16W	5%	RMC1/16S 472JTH	J24189033		1-	A	A1
R 1350	CHIP RES.	680k	1/16W	5%	RMC1/16S 684JTH	J24189059		1-	A	A1
R 1351	CHIP RES.	470k	1/16W	5%	RMC1/16S 474JTH	J24189057		1-	A	A1
R 1352	CHIP RES.	22k	1/16W	5%	RMC1/16S 223JTH	J24189041		1-	A	B1
R 1353	CHIP RES.	47	1/16W	5%	RMC1/16S 470JTH	J24189009		1-	B	f4
R 1354	CHIP RES.	220k	1/16W	5%	RMC1/16S 224JTH	J24189053		1-	A	A4
R 1355	CHIP RES.	2.2k	1/16W	5%	RMC1/16S 222JTH	J24189029		1-	A	B4
R 1356	CHIP RES.	56k	1/16W	0.5%	RR0510R-563-D	J24189161		1-	A	A4
R 1357	CHIP RES.	100k	1/16W	0.5%	RR0510R-104-D	J24189167		1-	A	A4
R 1358	CHIP RES.	100k	1/16W	0.5%	RR0510R-104-D	J24189167		1-	A	A4
R 1359	CHIP RES.	39k	1/16W	5%	RMC1/16S 393JTH	J24189044		1-	A	B4
R 1360	CHIP RES.	10k	1/16W	5%	RMC1/16S 103JTH	J24189037		1-	A	B4
R 1361	CHIP RES.	100k	1/16W	5%	RMC1/16S 104JTH	J24189049		1-	B	e5
R 1362	CHIP RES.	100k	1/16W	5%	RMC1/16S 104JTH	J24189049		1-	A	B4
R 1363	CHIP RES.	33	1/2W	5%	RMC1/2 330JCTP	J24275330		1-	B	e1
R 1364	CHIP RES.	4.7k	1/16W	5%	RMC1/16S 472JTH	J24189033		1-	B	e1
R 1365	CHIP RES.	1k	1/16W	5%	RMC1/16S 102JTH	J24189025		1-	B	e5
R 1366	CHIP RES.	1k	1/16W	5%	RMC1/16S 102JTH	J24189025		1-	B	e5
R 1367	CHIP RES.	1k	1/16W	5%	RMC1/16S 102JTH	J24189025		1-	B	e5
R 1368	CHIP RES.	1k	1/16W	5%	RMC1/16S 102JTH	J24189025		1-	B	e5
R 1369	CHIP RES.	1k	1/16W	5%	RMC1/16S 102JTH	J24189025		1-	A	B5
R 1370	CHIP RES.	47k	1/16W	5%	RMC1/16S 473JTH	J24189045		1-	B	f5

REF	DESCRIPTION	VALUE	V/W	TOL.	MFR'S DESIG	VXSTD P/N	VERS.	LOT	SIDE	LAY ADR
R 1371	CHIP RES.	4.7k	1/16W	5%	RMC1/16S 472JTH	J24189033		1-	A	A2
R 1372	CHIP RES.	220	1/16W	5%	RMC1/16S 221JTH	J24189017		1-	A	B2
R 1373	CHIP RES.	220	1/16W	5%	RMC1/16S 221JTH	J24189017		1-	A	A2
R 1374	CHIP RES.	220	1/16W	5%	RMC1/16S 221JTH	J24189017		1-	A	A2
R 1375	CHIP RES.	220	1/16W	5%	RMC1/16S 221JTH	J24189017		1-	A	A2
R 1376	CHIP RES.	47k	1/16W	5%	RMC1/16S 473JTH	J24189045		1-	A	A1
R 1377	CHIP RES.	22k	1/16W	5%	RMC1/16S 223JTH	J24189041		1-	A	A2
R 1378	CHIP RES.	47k	1/16W	5%	RMC1/16S 473JTH	J24189045		1-	B	f3
R 1379	CHIP RES.	470k	1/16W	5%	RMC1/16S 474JTH	J24189057		1-	B	f3
R 1381	CHIP RES.	15k	1/16W	5%	RMC1/16S 153JTH	J24189039		1-	B	f3
R 1382	CHIP RES.	220k	1/16W	5%	RMC1/16S 224JTH	J24189053		1-	B	f4
R 1383	CHIP RES.	10k	1/16W	5%	RMC1/16S 103JTH	J24189037		1-	B	f4
R 1384	CHIP RES.	22k	1/16W	5%	RMC1/16S 223JTH	J24189041		1-	B	g3
R 1385	CHIP RES.	47k	1/16W	5%	RMC1/16S 473JTH	J24189045		1-	B	f3
R 1386	CHIP RES.	470k	1/16W	5%	RMC1/16S 474JTH	J24189057		1-	B	g4
R 1387	CHIP RES.	470k	1/16W	5%	RMC1/16S 474JTH	J24189057		1-	B	g4
R 1388	CHIP RES.	47k	1/16W	5%	RMC1/16S 473JTH	J24189045		1-	B	f5
R 1389	CHIP RES.	1M	1/16W	5%	RMC1/16S 105JTH	J24189061		1-	B	f5
R 1390	CHIP RES.	470	1/16W	5%	RMC1/16S 471JTH	J24189021		1-	B	f5
R 1391	CHIP RES.	1k	1/16W	5%	RMC1/16S 102JTH	J24189025		1-	B	f5
R 1392	CHIP RES.	1k	1/16W	5%	RMC1/16S 102JTH	J24189025		1-	B	f5
R 1393	CHIP RES.	22k	1/16W	5%	RMC1/16S 223JTH	J24189041		1-	B	f5
R 1394	CHIP RES.	100k	1/16W	0.5%	RR0510R-104-D	J24189167		1-	B	f3
R 1395	CHIP RES.	2.2M	1/16W	5%	RMC1/16S 225JTH	J24189065		1-	A	A4
R 1396	CHIP RES.	4.7k	1/16W	5%	RMC1/16S 472JTH	J24189033		1-	A	A4
R 1397	CHIP RES.	3.9k	1/16W	5%	RMC1/16S 392JTH	J24189032		1-	A	A4
R 1398	CHIP RES.	22k	1/16W	5%	RMC1/16S 223JTH	J24189041		1-	A	A4
R 1399	CHIP RES.	100k	1/16W	5%	RMC1/16S 104JTH	J24189049		1-	A	A4
R 1400	CHIP RES.	220k	1/16W	5%	RMC1/16S 224JTH	J24189053		1-	A	A4
R 1401	CHIP RES.	220k	1/16W	5%	RMC1/16S 224JTH	J24189053		1-	A	A4
R 1402	CHIP RES.	330k	1/16W	5%	RMC1/16S 334JTH	J24189055		1-	A	A4
R 1403	CHIP RES.	68k	1/16W	5%	RMC1/16S 683JTH	J24189047		1-	A	A4
R 1404	CHIP RES.	10k	1/16W	5%	RMC1/16S 103JTH	J24189037		1-	A	A4
R 1405	CHIP RES.	390k	1/16W	5%	RMC1/16S 394JTH	J24189056		1-	A	A4
R 1406	CHIP RES.	68k	1/16W	5%	RMC1/16S 683JTH	J24189047		1-	B	f5
R 1407	CHIP RES.	150k	1/16W	5%	RMC1/16S 154JTH	J24189051		1-	A	A4
R 1408	CHIP RES.	150k	1/16W	5%	RMC1/16S 154JTH	J24189051		1-	A	A4
R 1409	CHIP RES.	33k	1/16W	0.5%	RR0510R-333-D	J24189155		1-	A	A4
R 1410	CHIP RES.	56k	1/16W	0.5%	RR0510R-563-D	J24189161		1-	A	B4
R 1411	CHIP RES.	10k	1/16W	5%	RMC1/16S 103JTH	J24189037		1-	A	B4
R 1413	CHIP RES.	8.2k	1/16W	5%	RMC1/16S 822JTH	J24189036		1-	A	F5
R 1414	CHIP RES.	15k	1/16W	5%	RMC1/16S 153JTH	J24189039		1-	A	F5
R 1415	CHIP RES.	8.2k	1/16W	5%	RMC1/16S 822JTH	J24189036		1-	A	D4
R 1416	CHIP RES.	15k	1/16W	5%	RMC1/16S 153JTH	J24189039		1-	A	D4
R 1417	CHIP RES.	2.2k	1/16W	5%	RMC1/16S 222JTH	J24189029		1-	B	a4
R 1418	CHIP RES.	2.2k	1/16W	5%	RMC1/16S 222JTH	J24189029		1-	B	a5
R 1419	CHIP RES.	100k	1/16W	5%	RMC1/16S 104JTH	J24189049		1-	B	a5
R 1420	CHIP RES.	100k	1/16W	5%	RMC1/16S 104JTH	J24189049		1-	B	a4
R 1421	CHIP RES.	1k	1/16W	5%	RMC1/16S 102JTH	J24189025		1-	A	D4
R 1422	CHIP RES.	1k	1/16W	5%	RMC1/16S 102JTH	J24189025		1-	B	f5
R 1423	CHIP RES.	1k	1/16W	5%	RMC1/16S 102JTH	J24189025		1-	B	f5
R 1424	CHIP RES.	1k	1/16W	5%	RMC1/16S 102JTH	J24189025		1-	B	f5
R 1425	CHIP RES.	1k	1/16W	5%	RMC1/16S 102JTH	J24189025		1-	A	A5
R 1426	CHIP RES.	100	1/16W	5%	RMC1/16S 101JTH	J24189013		1-	B	f5
R 1427	CHIP RES.	100	1/16W	5%	RMC1/16S 101JTH	J24189013		1-	B	f5
R 1428	CHIP RES.	1k	1/16W	5%	RMC1/16S 102JTH	J24189025		1-	A	A5
R 1429	CHIP RES.	1k	1/16W	5%	RMC1/16S 102JTH	J24189025		1-	A	A5
R 1430	CHIP RES.	0	1/16W	5%	RMC1/16S JPTH	J24189070	VER.A2 DST:USA	1-	A	A5
R 1430	CHIP RES.	0	1/16W	5%	RMC1/16S JPTH	J24189070	VERSION A1	1-	A	A5
R 1430	CHIP RES.	0	1/16W	5%	RMC1/16S JPTH	J24189070	VERSION A2	1-	A	A5
R 1430	CHIP RES.	0	1/16W	5%	RMC1/16S JPTH	J24189070	VERSION C1	1-	A	A5
R 1430	CHIP RES.	0	1/16W	5%	RMC1/16S JPTH	J24189070	VERSION C2	1-	A	A5
R 1430	CHIP RES.	0	1/16W	5%	RMC1/16S JPTH	J24189070	VERSION D1	1-	A	A5
R 1430	CHIP RES.	0	1/16W	5%	RMC1/16S JPTH	J24189070	VERSION D2	1-	A	A5
R 1431	CHIP RES.	0	1/16W	5%	RMC1/16S JPTH	J24189070	VERSION B1	1-	A	A5
R 1431	CHIP RES.	0	1/16W	5%	RMC1/16S JPTH	J24189070	VERSION B2	1-	A	A5
R 1431	CHIP RES.	0	1/16W	5%	RMC1/16S JPTH	J24189070	VERSION C3	1-	A	A5
R 1431	CHIP RES.	0	1/16W	5%	RMC1/16S JPTH	J24189070	VERSION D1	1-	A	A5
R 1431	CHIP RES.	0	1/16W	5%	RMC1/16S JPTH	J24189070	VERSION D2	1-	A	A5
R 1432	CHIP RES.	0	1/16W	5%	RMC1/16S JPTH	J24189070	VERSION B3	1-	A	A5
R 1432	CHIP RES.	0	1/16W	5%	RMC1/16S JPTH	J24189070	VERSION C1	1-	A	A5
R 1432	CHIP RES.	0	1/16W	5%	RMC1/16S JPTH	J24189070	VERSION C2	1-	A	A5
R 1432	CHIP RES.	0	1/16W	5%	RMC1/16S JPTH	J24189070	VERSION C3	1-	A	A5
R 1432	CHIP RES.	0	1/16W	5%	RMC1/16S JPTH	J24189070	VERSION D1	1-	A	A5
R 1432	CHIP RES.	0	1/16W	5%	RMC1/16S JPTH	J24189070	VERSION D2	1-	A	A5
R 1435	CHIP RES.	0	1/16W	5%	RMC1/16S JPTH	J24189070	VER.A2 DST:USA	1-	A	A5
R 1436	CHIP RES.	0	1/16W	5%	RMC1/16S JPTH	J24189070	VERSION A1	1-	A	A5

MAIN Unit

REF	DESCRIPTION	VALUE	V/W	TOL.	MFR'S DESIG	VXSTD P/N	VERS.	LOT	SIDE	LAY ADR
R 1436	CHIP RES.	0	1/16W	5%	RMC1/16S JPTH	J24189070	VERSION B1	1-	A	A5
R 1436	CHIP RES.	0	1/16W	5%	RMC1/16S JPTH	J24189070	VERSION C1	1-	A	A5
R 1436	CHIP RES.	0	1/16W	5%	RMC1/16S JPTH	J24189070	VERSION D1	1-	A	A5
R 1437	CHIP RES.	1k	1/16W	5%	RMC1/16S 102JTH	J24189025		1-	A	A5
R 1438	CHIP RES.	1k	1/16W	5%	RMC1/16S 102JTH	J24189025		1-	A	A5
R 1439	CHIP RES.	1k	1/16W	5%	RMC1/16S 102JTH	J24189025		1-	A	A5
R 1440	CHIP RES.	1k	1/16W	5%	RMC1/16S 102JTH	J24189025		1-	B	f5
R 1441	CHIP RES.	1k	1/16W	5%	RMC1/16S 102JTH	J24189025		1-	A	A5
R 1442	CHIP RES.	1k	1/16W	5%	RMC1/16S 102JTH	J24189025		1-	A	A5
R 1443	CHIP RES.	1k	1/16W	5%	RMC1/16S 102JTH	J24189025		1-	B	f5
R 1444	CHIP RES.	1k	1/16W	5%	RMC1/16S 102JTH	J24189025		1-	A	A4
R 1445	CHIP RES.	1k	1/16W	5%	RMC1/16S 102JTH	J24189025		1-	A	A4
R 1446	CHIP RES.	1k	1/16W	5%	RMC1/16S 102JTH	J24189025		1-	A	A4
R 1447	CHIP RES.	1k	1/16W	5%	RMC1/16S 102JTH	J24189025		1-	A	A4
R 1448	CHIP RES.	1k	1/16W	5%	RMC1/16S 102JTH	J24189025		1-	A	A4
R 1449	CHIP RES.	1k	1/16W	5%	RMC1/16S 102JTH	J24189025		1-	A	A4
R 1450	CHIP RES.	1k	1/16W	5%	RMC1/16S 102JTH	J24189025		1-	A	A4
R 1451	CHIP RES.	1k	1/16W	5%	RMC1/16S 102JTH	J24189025		1-	B	f5
R 1452	CHIP RES.	1k	1/16W	5%	RMC1/16S 102JTH	J24189025		1-	B	f5
R 1453	CHIP RES.	1.5M	1/16W	5%	RMC1/16S 155JTH	J24189063		1-	A	A4
R 1454	CHIP RES.	820k	1/16W	5%	RMC1/16S 824JTH	J24189060		1-	A	B4
R 1455	CHIP RES.	390k	1/16W	5%	RMC1/16S 394JTH	J24189056		1-	A	B4
R 1456	CHIP RES.	100k	1/16W	0.5%	RR0510R-104-D	J24189167		1-	A	B5
R 1457	CHIP RES.	100k	1/16W	0.5%	RR0510R-104-D	J24189167		1-	A	B4
R 1458	CHIP RES.	100k	1/16W	0.5%	RR0510R-104-D	J24189167		1-	A	B4
R 1459	CHIP RES.	100k	1/16W	0.5%	RR0510R-104-D	J24189167		1-	A	B4
R 1460	CHIP RES.	100k	1/16W	0.5%	RR0510R-104-D	J24189167		1-	A	B4
R 1461	CHIP RES.	10k	1/16W	5%	RMC1/16S 103JTH	J24189037		1-	A	B5
R 1462	CHIP RES.	1k	1/16W	5%	RMC1/16S 102JTH	J24189025		1-	B	f5
R 1463	CHIP RES.	100k	1/16W	0.5%	RR0510R-104-D	J24189167		1-	B	f5
R 1464	CHIP RES.	100k	1/16W	0.5%	RR0510R-104-D	J24189167		1-	B	f3
R 1465	CHIP RES.	100k	1/16W	0.5%	RR0510R-104-D	J24189167		1-	B	f3
R 1466	CHIP RES.	2.2k	1/16W	0.5%	RR0510P-222-D	J24189127		1-	A	B3
R 1467	CHIP RES.	1k	1/16W	5%	RMC1/16S 102JTH	J24189025		1-	A	B5
R 1468	CHIP RES.	1k	1/16W	5%	RMC1/16S 102JTH	J24189025		1-	A	B5
R 1469	CHIP RES.	1k	1/16W	5%	RMC1/16S 102JTH	J24189025		1-	A	B5
R 1470	CHIP RES.	1k	1/16W	5%	RMC1/16S 102JTH	J24189025		1-	A	B5
R 1471	CHIP RES.	1k	1/16W	5%	RMC1/16S 102JTH	J24189025		1-	A	B5
R 1472	CHIP RES.	1k	1/16W	5%	RMC1/16S 102JTH	J24189025		1-	A	B5
R 1473	CHIP RES.	1k	1/16W	5%	RMC1/16S 102JTH	J24189025		1-	A	B5
R 1474	CHIP RES.	10k	1/16W	5%	RMC1/16S 103JTH	J24189037		1-	B	f5
R 1475	CHIP RES.	100	1/16W	5%	RMC1/16S 101JTH	J24189013		1-	B	f5
R 1476	CHIP RES.	1k	1/16W	5%	RMC1/16S 102JTH	J24189025		1-	B	f5
R 1477	CHIP RES.	1k	1/16W	5%	RMC1/16S 102JTH	J24189025		1-	B	f5
R 1478	CHIP RES.	1k	1/16W	5%	RMC1/16S 102JTH	J24189025		1-	A	B5
R 1479	CHIP RES.	1k	1/16W	5%	RMC1/16S 102JTH	J24189025		1-	A	B5
R 1480	CHIP RES.	1k	1/16W	5%	RMC1/16S 102JTH	J24189025		1-	A	B5
R 1481	CHIP RES.	1k	1/16W	5%	RMC1/16S 102JTH	J24189025		1-	A	B5
R 1482	CHIP RES.	100	1/16W	5%	RMC1/16S 101JTH	J24189013		1-	A	B5
R 1483	CHIP RES.	100	1/16W	5%	RMC1/16S 101JTH	J24189013		1-	A	B5
R 1484	CHIP RES.	1k	1/16W	5%	RMC1/16S 102JTH	J24189025		1-	A	B5
R 1485	CHIP RES.	1k	1/16W	5%	RMC1/16S 102JTH	J24189025		1-	A	B5
R 1486	CHIP RES.	1k	1/16W	5%	RMC1/16S 102JTH	J24189025		1-	A	B4
R 1487	CHIP RES.	10k	1/16W	5%	RMC1/16S 103JTH	J24189037		1-	B	f5
R 1488	CHIP RES.	1k	1/16W	5%	RMC1/16S 102JTH	J24189025		1-	A	B4
R 1489	CHIP RES.	100k	1/16W	5%	RMC1/16S 104JTH	J24189049		1-	B	e5
R 1490	CHIP RES.	39k	1/16W	5%	RMC1/16S 393JTH	J24189044		1-	B	e4
R 1491	CHIP RES.	10k	1/16W	5%	RMC1/16S 103JTH	J24189037		1-	A	B4
R 1492	CHIP RES.	1k	1/16W	5%	RMC1/16S 102JTH	J24189025		1-	B	e5
R 1493	CHIP RES.	27k	1/16W	5%	RMC1/16S 273JTH	J24189042		1-	B	e5
R 1494	CHIP RES.	680	1/16W	5%	RMC1/16S 681JTH	J24189023		1-	A	C4
R 1495	CHIP RES.	330	1/16W	5%	RMC1/16S 331JTH	J24189019		1-	A	C4
R 1496	CHIP RES.	150	1/16W	5%	RMC1/16S 151JTH	J24189015		1-	A	C4
R 1497	CHIP RES.	2.2k	1/16W	5%	RMC1/16S 222JTH	J24189029		1-	A	C4
R 1498	CHIP RES.	2.2k	1/16W	5%	RMC1/16S 222JTH	J24189029		1-	A	C4
R 1499	CHIP RES.	47k	1/16W	5%	RMC1/16S 473JTH	J24189045		1-	B	e4
R 1500	CHIP RES.	10k	1/16W	5%	RMC1/16S 103JTH	J24189037		1-	B	d4
R 1501	CHIP RES.	22k	1/16W	5%	RMC1/16S 223JTH	J24189041		1-	A	C5
R 1502	CHIP RES.	100k	1/16W	5%	RMC1/16S 104JTH	J24189049		1-	A	C4
R 1503	CHIP RES.	680k	1/16W	5%	RMC1/16S 684JTH	J24189059		1-	A	C4
R 1504	CHIP RES.	100	1/16W	5%	RMC1/16S 101JTH	J24189013		1-	A	C4
R 1505	CHIP RES.	220k	1/16W	5%	RMC1/16S 224JTH	J24189053		1-	A	C4
R 1506	CHIP RES.	10k	1/16W	5%	RMC1/16S 103JTH	J24189037		1-	A	C5
R 1507	CHIP RES.	10k	1/16W	5%	RMC1/16S 103JTH	J24189037		1-	A	C5
R 1508	CHIP RES.	10k	1/16W	5%	RMC1/16S 103JTH	J24189037		1-	A	C4
R 1509	CHIP RES.	47	1/16W	5%	RMC1/16S 470JTH	J24189009		1-	A	C4
R 1510	CHIP RES.	100	1/16W	5%	RMC1/16S 101JTH	J24189013		1-	B	d4

REF	DESCRIPTION	VALUE	V/W	TOL.	MFR'S DESIG	VXSTD P/N	VERS.	LOT	SIDE	LAY ADR
R 1511	CHIP RES.	470k	1/16W	5%	RMC1/16S 474JTH	J24189057		1-	B	d5
R 1512	CHIP RES.	120k	1/16W	5%	RMC1/16S 124JTH	J24189050		1-	B	e4
R 1513	CHIP RES.	82k	1/16W	5%	RMC1/16S 823JTH	J24189048		1-	B	e5
R 1514	CHIP RES.	100k	1/16W	5%	RMC1/16S 104JTH	J24189049		1-	B	d5
R 1515	CHIP RES.	470k	1/16W	5%	RMC1/16S 474JTH	J24189057		1-	B	d5
R 1516	CHIP RES.	100k	1/16W	5%	RMC1/16S 104JTH	J24189049		1-	B	d5
R 1517	CHIP RES.	47k	1/16W	5%	RMC1/16S 473JTH	J24189045		1-	B	d4
R 1518	CHIP RES.	150k	1/16W	5%	RMC1/16S 154JTH	J24189051		1-	B	d4
R 1519	CHIP RES.	330k	1/16W	5%	RMC1/16S 334JTH	J24189055		1-	B	d5
R 1520	CHIP RES.	100	1/16W	5%	RMC1/16S 101JTH	J24189013		1-	A	D4
R 1521	CHIP RES.	82k	1/16W	5%	RMC1/16S 823JTH	J24189048		1-	B	d5
R 1522	CHIP RES.	18k	1/16W	5%	RMC1/16S 183JTH	J24189040		1-	B	d5
R 1523	CHIP RES.	22k	1/16W	5%	RMC1/16S 223JTH	J24189041		1-	A	D5
R 1524	CHIP RES.	100k	1/16W	5%	RMC1/16S 104JTH	J24189049		1-	A	D5
R 1525	CHIP RES.	680k	1/16W	5%	RMC1/16S 684JTH	J24189059		1-	A	D5
R 1526	CHIP RES.	220k	1/16W	5%	RMC1/16S 224JTH	J24189053		1-	A	D5
R 1527	CHIP RES.	10k	1/16W	5%	RMC1/16S 103JTH	J24189037		1-	A	D5
R 1528	CHIP RES.	10k	1/16W	5%	RMC1/16S 103JTH	J24189037		1-	A	D5
R 1529	CHIP RES.	10k	1/16W	5%	RMC1/16S 103JTH	J24189037		1-	A	D5
R 1530	CHIP RES.	100	1/16W	5%	RMC1/16S 101JTH	J24189013		1-	A	E5
R 1531	CHIP RES.	680	1/16W	5%	RMC1/16S 681JTH	J24189023		1-	A	E5
R 1532	CHIP RES.	470	1/16W	5%	RMC1/16S 471JTH	J24189021		1-	A	E5
R 1533	CHIP RES.	2.2k	1/16W	5%	RMC1/16S 222JTH	J24189029		1-	A	E5
R 1534	CHIP RES.	1.5k	1/16W	5%	RMC1/16S 152JTH	J24189027		1-	A	E5
R 1535	CHIP RES.	47	1/16W	5%	RMC1/16S 470JTH	J24189009		1-	A	D5
R 1536	CHIP RES.	2.2k	1/16W	5%	RMC1/16S 222JTH	J24189029		1-	A	D5
R 1537	CHIP RES.	47k	1/16W	5%	RMC1/16S 473JTH	J24189045		1-	B	c5
R 1538	CHIP RES.	470k	1/16W	5%	RMC1/16S 474JTH	J24189057		1-	B	c5
R 1539	CHIP RES.	1M	1/16W	5%	RMC1/16S 105JTH	J24189061		1-	B	c5
R 1540	CHIP RES.	2.7k	1/16W	5%	RMC1/16S 272JTH	J24189030		1-	A	D5
R 1541	CHIP RES.	47k	1/16W	5%	RMC1/16S 473JTH	J24189045		1-	B	c5
R 1542	CHIP RES.	330k	1/16W	5%	RMC1/16S 334JTH	J24189055		1-	B	c5
R 1543	CHIP RES.	150k	1/16W	5%	RMC1/16S 154JTH	J24189051		1-	B	c5
R 1544	CHIP RES.	18k	1/16W	5%	RMC1/16S 183JTH	J24189040		1-	B	c5
R 1545	CHIP RES.	100k	1/16W	5%	RMC1/16S 104JTH	J24189049		1-	B	c5
R 1546	CHIP RES.	18k	1/16W	5%	RMC1/16S 183JTH	J24189040		1-	B	d4
R 1547	CHIP RES.	4.7k	1/16W	5%	RMC1/16S 472JTH	J24189033		1-	B	d4
R 1548	CHIP RES.	68k	1/16W	5%	RMC1/16S 683JTH	J24189047		1-	B	e4
R 1549	CHIP RES.	82k	1/16W	5%	RMC1/16S 823JTH	J24189048		1-	A	B4
R 1550	CHIP RES.	100k	1/16W	5%	RMC1/16S 104JTH	J24189049		1-	A	B4
R 1551	CHIP RES.	47k	1/16W	5%	RMC1/16S 473JTH	J24189045		1-	B	e4
R 1552	CHIP RES.	10k	1/16W	5%	RMC1/16S 103JTH	J24189037		1-	A	D4
R 1553	CHIP RES.	100k	1/16W	5%	RMC1/16S 104JTH	J24189049		1-	B	d4
R 1554	CHIP RES.	220k	1/16W	5%	RMC1/16S 224JTH	J24189053		1-	B	d4
R 1555	CHIP RES.	180	1/16W	5%	RMC1/16S 181JTH	J24189016		1-	B	d4
R 1556	CHIP RES.	3.3k	1/16W	5%	RMC1/16S 332JTH	J24189031		1-	B	d4
R 1557	CHIP RES.	22k	1/16W	5%	RMC1/16S 223JTH	J24189041		1-	B	d4
R 1558	CHIP RES.	15k	1/16W	5%	RMC1/16S 153JTH	J24189039		1-	B	d4
R 1559	CHIP RES.	47	1/16W	5%	RMC1/16S 470JTH	J24189009		1-	B	d4
R 1560	CHIP RES.	470	1/16W	5%	RMC1/16S 471JTH	J24189021		1-	B	d4
R 1561	CHIP RES.	33k	1/16W	5%	RMC1/16S 333JTH	J24189043		1-	B	d4
R 1562	CHIP RES.	680	1/16W	5%	RMC1/16S 681JTH	J24189023		1-	B	d4
R 1563	CHIP RES.	47	1/16W	5%	RMC1/16S 470JTH	J24189009		1-	A	C4
R 1564	CHIP RES.	10k	1/16W	5%	RMC1/16S 103JTH	J24189037		1-	A	C4
R 1565	CHIP RES.	33k	1/16W	5%	RMC1/16S 333JTH	J24189043		1-	A	C4
R 1566	CHIP RES.	330	1/16W	5%	RMC1/16S 331JTH	J24189019		1-	B	d4
R 1567	CHIP RES.	100	1/16W	5%	RMC1/16S 101JTH	J24189013		1-	A	C4
R 1568	CHIP RES.	3.3k	1/16W	5%	RMC1/16S 332JTH	J24189031		1-	A	D4
R 1569	CHIP RES.	15k	1/16W	5%	RMC1/16S 153JTH	J24189039		1-	B	d4
R 1570	CHIP RES.	22k	1/16W	5%	RMC1/16S 223JTH	J24189041		1-	B	d4
R 1571	CHIP RES.	2.2k	1/16W	5%	RMC1/16S 222JTH	J24189029		1-	B	d4
R 1572	CHIP RES.	1k	1/16W	5%	RMC1/16S 102JTH	J24189025		1-	B	d4
R 1573	CHIP RES.	220	1/16W	5%	RMC1/16S 221JTH	J24189017		1-	B	d4
R 1574	CHIP RES.	1k	1/16W	5%	RMC1/16S 102JTH	J24189025		1-	B	d4
R 1575	CHIP RES.	33k	1/16W	5%	RMC1/16S 333JTH	J24189043		1-	B	d4
R 1576	CHIP RES.	100	1/16W	5%	RMC1/16S 101JTH	J24189013		1-	A	C4
R 1577	CHIP RES.	220	1/16W	5%	RMC1/16S 221JTH	J24189017		1-	A	C4
R 1578	CHIP RES.	47	1/16W	5%	RMC1/16S 470JTH	J24189009		1-	A	D4
R 1579	CHIP RES.	100k	1/16W	5%	RMC1/16S 104JTH	J24189049		1-	A	D4
R 1580	CHIP RES.	1k	1/16W	5%	RMC1/16S 102JTH	J24189025		1-	B	e4
R 1581	CHIP RES.	10k	1/16W	5%	RMC1/16S 103JTH	J24189037		1-	A	C4
R 1582	CHIP RES.	3.3k	1/16W	5%	RMC1/16S 332JTH	J24189031		1-	A	D4
R 1583	CHIP RES.	15k	1/16W	5%	RMC1/16S 153JTH	J24189039		1-	B	c4
R 1584	CHIP RES.	22k	1/16W	5%	RMC1/16S 223JTH	J24189041		1-	B	c5
R 1585	CHIP RES.	680	1/16W	5%	RMC1/16S 681JTH	J24189023		1-	B	c5
R 1586	CHIP RES.	47	1/16W	5%	RMC1/16S 470JTH	J24189009		1-	B	c5
R 1587	CHIP RES.	470	1/16W	5%	RMC1/16S 471JTH	J24189021		1-	B	c4

MAIN Unit

REF	DESCRIPTION	VALUE	V/W	TOL.	MFR'S DESIG	VXSTD P/N	VERS.	LOT	SIDE	LAY ADR
R 1588	CHIP RES.	33k	1/16W	5%	RMC1/16S 333JTH	J24189043		1-	B	b5
R 1589	CHIP RES.	100k	1/16W	5%	RMC1/16S 104JTH	J24189049		1-	A	E4
R 1590	CHIP RES.	2.2k	1/16W	5%	RMC1/16S 222JTH	J24189029		1-	B	c4
R 1591	CHIP RES.	15k	1/16W	5%	RMC1/16S 153JTH	J24189039		1-	B	c4
R 1592	CHIP RES.	22k	1/16W	5%	RMC1/16S 223JTH	J24189041		1-	B	c4
R 1593	CHIP RES.	1k	1/16W	5%	RMC1/16S 102JTH	J24189025		1-	B	c4
R 1594	CHIP RES.	220	1/16W	5%	RMC1/16S 221JTH	J24189017		1-	B	c4
R 1595	CHIP RES.	1k	1/16W	5%	RMC1/16S 102JTH	J24189025		1-	B	b4
R 1596	CHIP RES.	33k	1/16W	5%	RMC1/16S 333JTH	J24189043		1-	B	b4
R 1597	CHIP RES.	100	1/16W	5%	RMC1/16S 101JTH	J24189013		1-	A	E4
R 1598	CHIP RES.	220	1/16W	5%	RMC1/16S 221JTH	J24189017		1-	A	E4
R 1599	CHIP RES.	10k	1/16W	5%	RMC1/16S 103JTH	J24189037		1-	A	D5
R 1600	CHIP RES.	10k	1/16W	5%	RMC1/16S 103JTH	J24189037		1-	A	D4
R 1601	CHIP RES.	100k	1/16W	5%	RMC1/16S 104JTH	J24189049		1-	A	E5
R 1602	CHIP RES.	10	1/16W	5%	RMC1/16S 100JTH	J24189001		1-	A	C3
R 1603	CHIP RES.	1k	1/16W	5%	RMC1/16S 102JTH	J24189025		1-	B	f3
R 1604	CHIP RES.	1k	1/16W	5%	RMC1/16S 102JTH	J24189025		1-	B	c2
R 1605	CHIP RES.	330k	1/16W	5%	RMC1/16S 334JTH	J24189055		1-	B	e3
R 1606	CHIP RES.	100	1/16W	5%	RMC1/16S 101JTH	J24189013		1-	B	e3
R 1607	CHIP RES.	100	1/16W	5%	RMC1/16S 101JTH	J24189013		1-	B	e3
R 1608	CHIP RES.	3.3k	1/16W	5%	RMC1/16S 332JTH	J24189031		1-	B	e3
R 1609	CHIP RES.	6.8k	1/16W	5%	RMC1/16S 682JTH	J24189035		1-	B	e3
R 1610	CHIP RES.	33k	1/16W	5%	RMC1/16S 333JTH	J24189043		1-	B	f3
R 1611	CHIP RES.	470k	1/16W	5%	RMC1/16S 474JTH	J24189057		1-	B	f3
R 1613	CHIP RES.	47	1/16W	5%	RMC1/16S 470JTH	J24189009		1-	B	d3
R 1614	CHIP RES.	150	1/16W	5%	RMC1/16S 151JTH	J24189015		1-	B	d3
R 1615	CHIP RES.	47	1/16W	5%	RMC1/16S 470JTH	J24189009		1-	B	d3
R 1616	CHIP RES.	100	1/16W	5%	RMC1/16S 101JTH	J24189013		1-	B	d3
R 1617	CHIP RES.	0	1/16W	5%	RMC1/16S JPTH	J24189070		1-	B	d3
R 1618	CHIP RES.	1k	1/16W	5%	RMC1/16S 102JTH	J24189025		1-	B	d3
R 1619	CHIP RES.	4.7k	1/16W	5%	RMC1/16S 472JTH	J24189033		1-	B	d3
R 1620	CHIP RES.	220	1/16W	5%	RMC1/16S 221JTH	J24189017		1-	B	d3
R 1621	CHIP RES.	22k	1/16W	5%	RMC1/16S 223JTH	J24189041		1-	B	e3
R 1622	CHIP RES.	27k	1/16W	5%	RMC1/16S 273JTH	J24189042		1-	B	e3
R 1623	CHIP RES.	220	1/16W	5%	RMC1/16S 221JTH	J24189017		1-	B	d3
R 1624	CHIP RES.	220	1/16W	5%	RMC1/16S 221JTH	J24189017		1-	B	d3
R 1625	CHIP RES.	8.2k	1/16W	5%	RMC1/16S 822JTH	J24189036		1-	B	e3
R 1626	CHIP RES.	47	1/16W	5%	RMC1/16S 470JTH	J24189009		1-	B	e2
R 1627	CHIP RES.	12k	1/16W	5%	RMC1/16S 123JTH	J24189038		1-	B	d3
R 1628	CHIP RES.	220	1/16W	5%	RMC1/16S 221JTH	J24189017		1-	A	C3
R 1629	CHIP RES.	470	1/16W	5%	RMC1/16S 471JTH	J24189021		1-	A	C3
R 1630	CHIP RES.	100	1/16W	5%	RMC1/16S 101JTH	J24189013		1-	A	C3
R 1631	CHIP RES.	1k	1/16W	5%	RMC1/16S 102JTH	J24189025		1-	A	C3
R 1632	CHIP RES.	1k	1/16W	5%	RMC1/16S 102JTH	J24189025		1-	A	C2
R 1633	CHIP RES.	1k	1/16W	5%	RMC1/16S 102JTH	J24189025		1-	A	D3
R 1634	CHIP RES.	100	1/16W	5%	RMC1/16S 101JTH	J24189013		1-	A	D3
R 1635	CHIP RES.	82	1/16W	5%	RMC1/16S 820JTH	J24189012		1-	B	d3
R 1636	CHIP RES.	82	1/16W	5%	RMC1/16S 820JTH	J24189012		1-	B	d3
R 1637	CHIP RES.	220	1/2W	5%	RMC1/2 221JCTP	J24275221		1-	A	B3
R 1638	CHIP RES.	47	1/16W	5%	RMC1/16S 470JTH	J24189009		1-	B	e2
R 1639	CHIP RES.	47	1/16W	5%	RMC1/16S 470JTH	J24189009		1-	A	C2
R 1640	CHIP RES.	47	1/16W	5%	RMC1/16S 470JTH	J24189009		1-	B	e2
R 1641	CHIP RES.	820	1/2W	5%	RK73K2HTE820-OHMJ	J24279028		1-	B	e2
R 1642	CHIP RES.	820	1/2W	5%	RK73K2HTE820-OHMJ	J24279028		1-	B	d2
R 1643	CHIP RES.	470	1/2W	5%	RMC1/2 471JCTP	J24275471		1-	B	d2
R 1644	CHIP RES.	1k	1/4W	5%	RMC1/4 102JATP	J24245102		1-	A	C2
R 1647	CHIP RES.	82	1/16W	5%	RMC1/16S 820JTH	J24189012		1-	B	e1
R 1648	CHIP RES.	82	1/16W	5%	RMC1/16S 820JTH	J24189012		1-	B	e1
R 1649	CHIP RES.	22k	1/16W	5%	RMC1/16S 223JTH	J24189041		1-	B	e1
R 1650	CHIP RES.	8.2k	1/16W	5%	RMC1/16S 822JTH	J24189036		1-	B	e3
R 1651	CHIP RES.	10k	1/16W	5%	RMC1/16S 103JTH	J24189037		1-	B	b1
R 1652	CHIP RES.	10k	1/16W	5%	RMC1/16S 103JTH	J24189037		1-	B	b1
R 1653	CHIP RES.	10k	1/16W	5%	RMC1/16S 103JTH	J24189037		1-	B	b1
R 1654	CHIP RES.	33	1W	5%	RMC1 330JTE	J24305330		1-	A	F2
R 1655	CHIP RES.	33	1W	5%	RMC1 330JTE	J24305330		1-	A	E2
R 1656	CHIP RES.	33k	1/16W	5%	RMC1/16S 333JTH	J24189043		1-	B	c2
R 1657	CHIP RES.	10k	1/16W	5%	RMC1/16S 103JTH	J24189037		1-	B	a1
R 1658	CHIP RES.	100	1/16W	5%	RMC1/16S 101JTH	J24189013		1-	A	B2
R 1659	CHIP RES.	4.7k	1/16W	5%	RMC1/16S 472JTH	J24189033		1-	A	B2
R 1660	CHIP RES.	4.7k	1/16W	5%	RMC1/16S 472JTH	J24189033		1-	A	B2
R 1661	CHIP RES.	4.7k	1/16W	5%	RMC1/16S 472JTH	J24189033		1-	A	B2
R 1662	CHIP RES.	18	1/2W	5%	RMC1/2 180JTE	J24275180		1-	A	D2
R 1663	CHIP RES.	39	1W	5%	RMC1 390JTE	J24305390		1-	A	D2
R 1664	CHIP RES.	10k	1/16W	5%	RMC1/16S 103JTH	J24189037		1-	B	c2
R 1665	CHIP RES.	10k	1/16W	5%	RMC1/16S 103JTH	J24189037		1-	B	c2
R 1666	CHIP RES.	10k	1/16W	5%	RMC1/16S 103JTH	J24189037		1-	B	b2
R 1667	CHIP RES.	10k	1/16W	5%	RMC1/16S 103JTH	J24189037		1-	A	E2

REF	DESCRIPTION	VALUE	V/W	TOL.	MFR'S DESIG	VXSTD P/N	VERS.	LOT	SIDE	LAY ADR
R 1668	CHIP RES.	47	1/16W	5%	RMC1/16S 470JTH	J24189009		1-	B	b2
R 1672	CHIP RES.	0	1/16W	5%	RMC1/16S JPTH	J24189070		1-	B	b5
R 1673	CHIP RES.	1k	1/16W	5%	RMC1/16S 102JTH	J24189025		1-	B	b4
R 1677	CHIP RES.	0	1/16W	5%	RMC1/16S JPTH	J24189070		1-	B	b5
R 1678	CHIP RES.	1k	1/16W	5%	RMC1/16S 102JTH	J24189025		1-	B	b5
R 1679	CHIP RES.	47	1/16W	5%	RMC1/16S 470JTH	J24189009		1-	B	c3
R 1680	CHIP RES.	220	1/16W	5%	RMC1/16S 221JTH	J24189017		1-	A	D3
R 1681	CHIP RES.	100	1/16W	5%	RMC1/16S 101JTH	J24189013		1-	A	C3
R 1682	CHIP RES.	100	1/16W	5%	RMC1/16S 101JTH	J24189013		1-	A	C3
R 1685	CARBON FILM RES.	5.6k	1/6W	5%	RD16TPJ562 5.6K	J07225562		1-		
TH1001	THERMISTOR				TBPS1R103K440H5Q	G9090067		1-	A	C3
TH1002	THERMISTOR				TBPS1R103K440H5Q	G9090067		1-	B	d5
TH1003	THERMISTOR				TBPS1R473K475H5Q	G9090068		1-	B	d5
TH1004	THERMISTOR				TBPS1R473K475H5Q	G9090068		1-	B	c5
TH1005	THERMISTOR				TBPS1R103K440H5Q	G9090067		1-	B	c5
X 1001	XTAL CSA-310	3.6864MHz			3.6864MHZ	H0102988		1-	A	A4
X 1002	XTAL TSS-5032A	11.15MHz			11.15MHZ	H0103268		1-	B	d4
X 1003	XTAL TSS-6	11.7MHz			TSS-5032A 11.7MHZ	H0103264		1-	B	c5
XF1001	XTAL FILTER				MFT45R6 45.05MHZ	H1102351		1-	A	C4
XF1002	XTAL FILTER				MFT47R 47.25MHZ	H1102352		1-	A	E5
	SHIELD CASE VCO					RA0272500		1-		

MAIN Unit

Note:

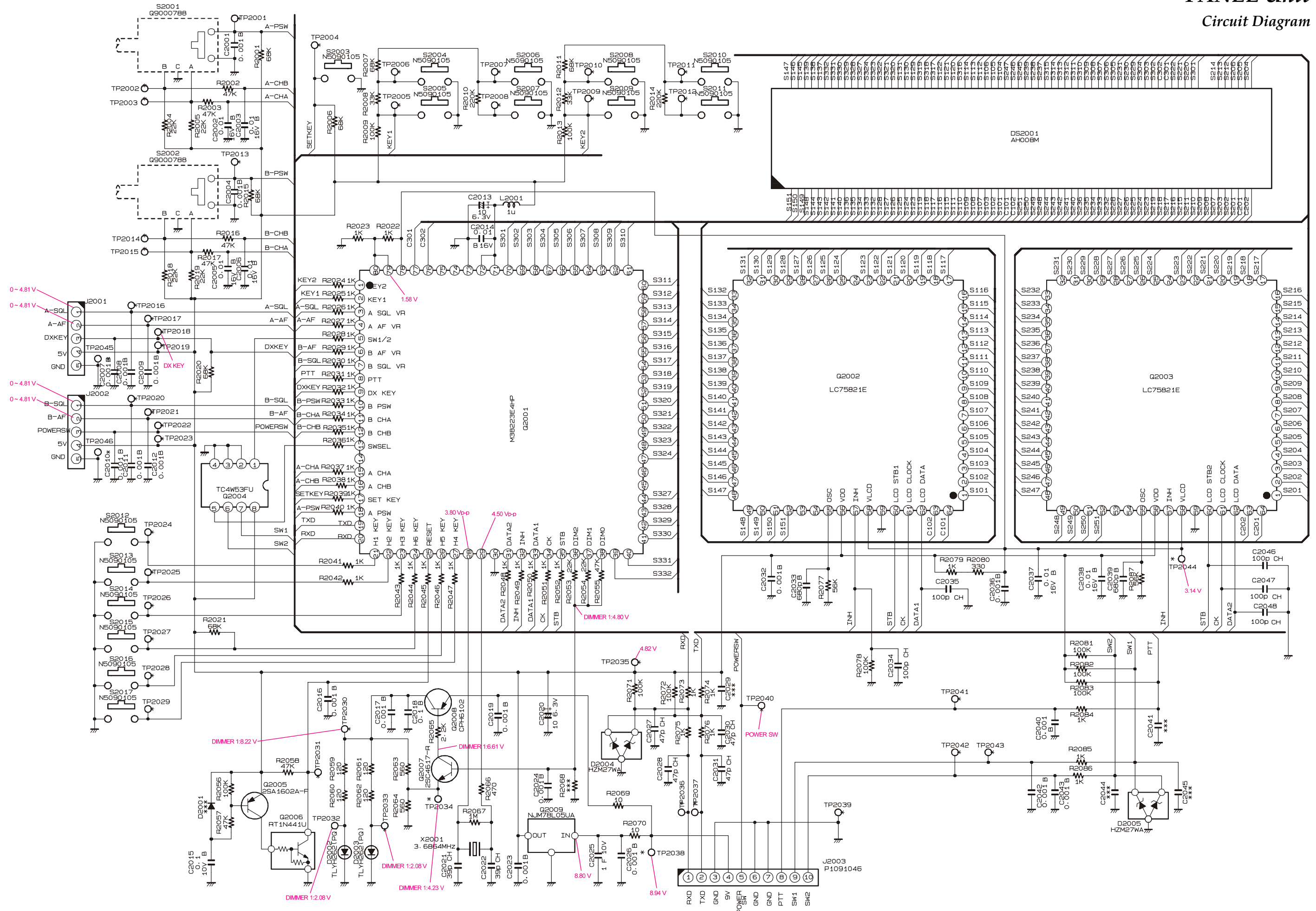

PANEL Unit

Parts Layout

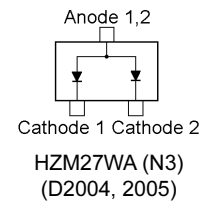
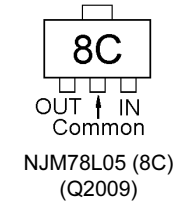
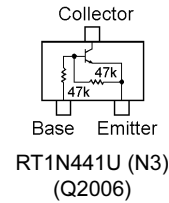
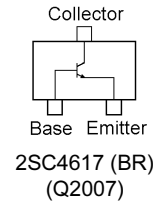
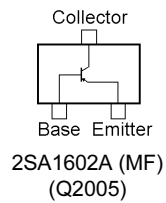
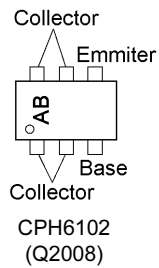
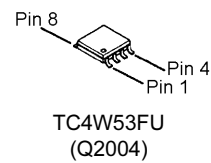
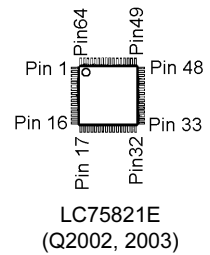
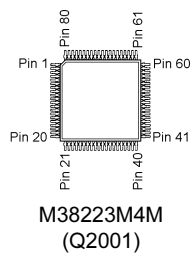
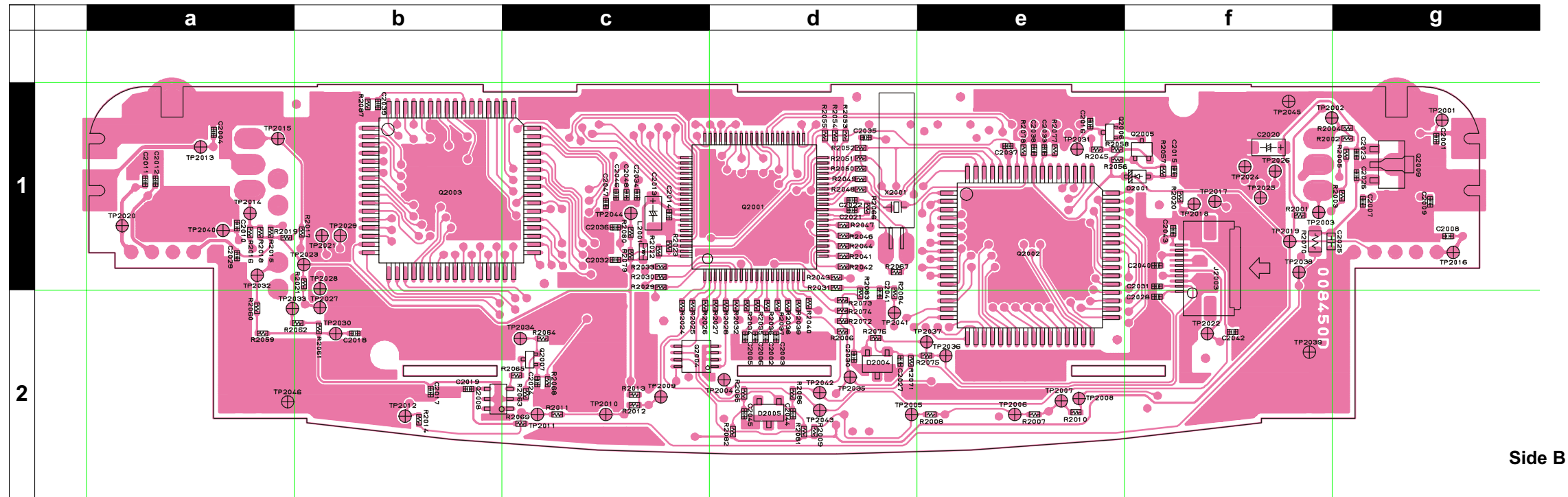
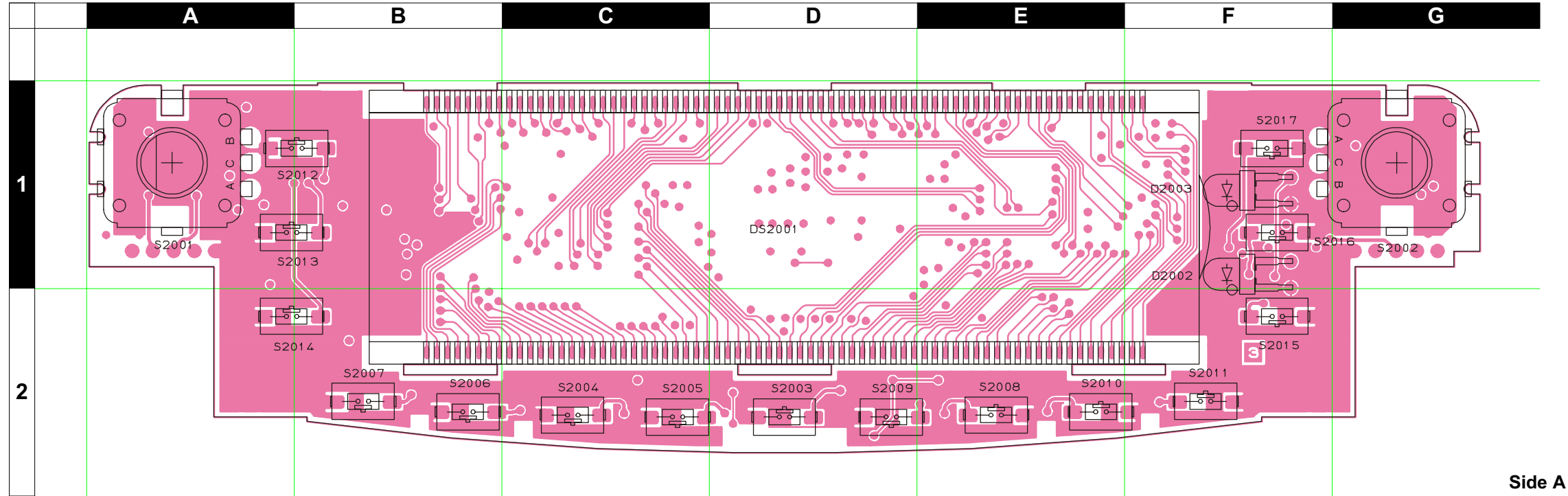

Parts List

REF	DESCRIPTION	VALUE	V/W	TOL.	MFR'S DESIG	VXSTD P/N	VERS.	LOT	SIDE	LAY ADR
PCB with Components						CB2513001				
Printed Circuit Board						FR0084500				
AH008M000						1-				
C 2001	CHIP CAP.	0.001uF	50V	B	GRM36B102K50PT	K22178809		1-	B	g2
C 2002	CHIP CAP.	0.022uF	16V	B	GRM36B223K16PT	K22128806		1-	B	d2
C 2003	CHIP CAP.	0.022uF	16V	B	GRM36B223K16PT	K22128806		1-	B	d2
C 2004	CHIP CAP.	0.001uF	50V	B	GRM36B102K50PT	K22178809		1-	B	a2
C 2005	CHIP CAP.	0.022uF	16V	B	GRM36B223K16PT	K22128806		1-	B	d2
C 2006	CHIP CAP.	0.022uF	16V	B	GRM36B223K16PT	K22128806		1-	B	d2
C 2007	CHIP CAP.	0.001uF	50V	B	GRM36B102K50PT	K22178809		1-	B	g2
C 2008	CHIP CAP.	0.001uF	50V	B	GRM36B102K50PT	K22178809		1-	B	g2
C 2009	CHIP CAP.	0.001uF	50V	B	GRM36B102K50PT	K22178809		1-	B	g2
C 2010	CHIP CAP.	0.001uF	50V	B	GRM36B102K50PT	K22178809		1-	B	a2
C 2011	CHIP CAP.	0.001uF	50V	B	GRM36B102K50PT	K22178809		1-	B	a2
C 2012	CHIP CAP.	0.001uF	50V	B	GRM36B102K50PT	K22178809		1-	B	a2
C 2013	CHIP TA.CAP.	10uF	6.3V		TEMSVA0J106M-8R	K78080027		1-	B	c2
C 2014	CHIP CAP.	0.01uF	16V	B	GRM36B103K16PT	K22128804		1-	B	c2
C 2015	CHIP CAP.	0.1uF	10V	B	GRM36B104K10PT	K22108802		1-	B	f2
C 2016	CHIP CAP.	0.001uF	50V	B	GRM36B102K50PT	K22178809		1-	B	e2
C 2017	CHIP CAP.	0.001uF	50V	B	GRM36B102K50PT	K22178809		1-	B	b2
C 2018	CHIP CAP.	0.1uF	10V	B	GRM36B104K10PT	K22108802		1-	B	b2
C 2019	CHIP CAP.	0.001uF	50V	B	GRM36B102K50PT	K22178809		1-	B	b2
C 2020	CHIP TA.CAP.	10uF	6.3V		TEMSVA0J106M-8R	K78080027		1-	B	f2
C 2021	CHIP CAP.	39pF	50V	CH	GRM36CH390J50PT	K22178226		1-	B	d2
C 2022	CHIP CAP.	39pF	50V	CH	GRM36CH390J50PT	K22178226		1-	B	d2
C 2023	CHIP CAP.	0.001uF	50V	B	GRM36B102K50PT	K22178809		1-	B	g2
C 2024	CHIP CAP.	0.001uF	50V	B	GRM36B102K50PT	K22178809		1-	B	c2
C 2025	CHIP CAP.	1uF	10V	F	GRM39F105Z10PT	K22105001		1-	B	f2
C 2026	CHIP CAP.	0.001uF	50V	B	GRM36B102K50PT	K22178809		1-	B	g2
C 2027	CHIP CAP.	47pF	50V	CH	GRM36CH470J50PT	K22178228		1-	B	d2
C 2028	CHIP CAP.	47pF	50V	CH	GRM36CH470J50PT	K22178228		1-	B	f2
C 2030	CHIP CAP.	47pF	50V	CH	GRM36CH470J50PT	K22178228		1-	B	d2
C 2031	CHIP CAP.	47pF	50V	CH	GRM36CH470J50PT	K22178228		1-	B	f2
C 2032	CHIP CAP.	0.001uF	50V	B	GRM36B102K50PT	K22178809		1-	B	c2
C 2033	CHIP CAP.	680pF	50V	B	GRM36B681K50PT	K22178807		1-	B	e2
C 2034	CHIP CAP.	100pF	50V	CH	GRM36CH101J50PT	K22178236		1-	B	c2
C 2035	CHIP CAP.	100pF	50V	CH	GRM36CH101J50PT	K22178236		1-	B	d2
C 2036	CHIP CAP.	0.001uF	50V	B	GRM36B102K50PT	K22178809		1-	B	c2
C 2037	CHIP CAP.	0.01uF	16V	B	GRM36B103K16PT	K22128804		1-	B	e2
C 2038	CHIP CAP.	0.01uF	16V	B	GRM36B103K16PT	K22128804		1-	B	e2
C 2039	CHIP CAP.	680pF	50V	B	GRM36B681K50PT	K22178807		1-	B	b2
C 2040	CHIP CAP.	0.001uF	50V	B	GRM36B102K50PT	K22178809		1-	B	f2
C 2042	CHIP CAP.	0.001uF	50V	B	GRM36B102K50PT	K22178809		1-	B	f2
C 2043	CHIP CAP.	0.001uF	50V	B	GRM36B102K50PT	K22178809		1-	B	f2
C 2046	CHIP CAP.	100pF	50V	CH	GRM36CH101J50PT	K22178236		1-	B	c2
C 2047	CHIP CAP.	100pF	50V	CH	GRM36CH101J50PT	K22178236		1-	B	c2
C 2048	CHIP CAP.	100pF	50V	CH	GRM36CH101J50PT	K22178236		1-	B	c2
D 2002	LED				TLYH262(PQ)	G2090777		1-	A	F2
D 2003	LED				TLYH262(PQ)	G2090777		1-	A	F2
D 2004	DIODE				HZM27WA-TR	G2070530		1-	B	d2
D 2005	DIODE				HZM27WA-TR	G2070530		1-	B	d2
D 2006	DIODE				UDZS TE-17 6.8B	G2070888		1-	B	f2
D 2007	DIODE				UDZS TE-17 6.8B	G2070888		1-	B	f2
DS2001	LCD				050442-2	G6090147A		1-	A	D2
J 2003	CONNECTOR				IL-FHR-10S-HF-E3000	P1091046		1-	B	f2
L 2001	M.RFC	1uH			LK1608 1R0K-T	L1690687		1-	B	c2
Q 2001	IC				M38223M4M-363HP	G1093816		1-	B	d2
Q 2002	IC				LC75821E	G1092191		1-	B	e2
Q 2003	IC				LC75821E	G1092191		1-	B	b2
Q 2004	IC				TC4W53FU TE12L	G1091675		1-	B	c2
Q 2005	TRANSISTOR				2SA1602A-T11-1F	G3116028F		1-	B	f2
Q 2006	TRANSISTOR				RT1N441U-T11-1	G3070247		1-	B	e2
Q 2007	TRANSISTOR				2SC4617 TL R	G3346178R		1-	B	c2
Q 2008	TRANSISTOR				CPH6102-TL	G3070223		1-	B	b2
Q 2009	IC				NJM78L05UA TE1	G1091325		1-	B	g2
R 2001	CHIP RES.	68k	1/16W	5%	RMC1/16S 683JTH	J24189047		1-	B	f2
R 2002	CHIP RES.	47k	1/16W	5%	RMC1/16S 473JTH	J24189045		1-	B	g2
R 2003	CHIP RES.	47k	1/16W	5%	RMC1/16S 473JTH	J24189045		1-	B	g2
R 2004	CHIP RES.	22k	1/16W	5%	RMC1/16S 223JTH	J24189041		1-	B	g2
R 2005	CHIP RES.	22k	1/16W	5%	RMC1/16S 223JTH	J24189041		1-	B	g2
R 2006	CHIP RES.	68k	1/16W	5%	RMC1/16S 683JTH	J24189047		1-	B	d2
R 2007	CHIP RES.	68k	1/16W	5%	RMC1/16S 683JTH	J24189047		1-	B	e2
R 2008	CHIP RES.	33k	1/16W	5%	RMC1/16S 333JTH	J24189043		1-	B	e2
R 2009	CHIP RES.	100k	1/16W	5%	RMC1/16S 104JTH	J24189049		1-	B	d2
R 2010	CHIP RES.	220k	1/16W	5%	RMC1/16S 224JTH	J24189053		1-	B	e2
R 2011	CHIP RES.	68k	1/16W	5%	RMC1/16S 683JTH	J24189047		1-	B	c2
R 2012	CHIP RES.	33k	1/16W	5%	RMC1/16S 333JTH	J24189043		1-	B	c2
R 2013	CHIP RES.	100k	1/16W	5%	RMC1/16S 104JTH	J24189049		1-	B	c2

PANEL Unit

REF	DESCRIPTION	VALUE	V/W	TOL.	MFR'S DESIG	VXSTD P/N	VERS.	LOT	SIDE	LAY ADR
R 2014	CHIP RES.	220k	1/16W	5%	RMC1/16S 224JTH	J24189053		1-	B	b2
R 2015	CHIP RES.	68k	1/16W	5%	RMC1/16S 683JTH	J24189047		1-	B	a2
R 2016	CHIP RES.	47k	1/16W	5%	RMC1/16S 473JTH	J24189045		1-	B	a2
R 2017	CHIP RES.	47k	1/16W	5%	RMC1/16S 473JTH	J24189045		1-	B	b2
R 2018	CHIP RES.	22k	1/16W	5%	RMC1/16S 223JTH	J24189041		1-	B	a2
R 2019	CHIP RES.	22k	1/16W	5%	RMC1/16S 223JTH	J24189041		1-	B	a2
R 2020	CHIP RES.	68k	1/16W	5%	RMC1/16S 683JTH	J24189047		1-	B	f2
R 2021	CHIP RES.	68k	1/16W	5%	RMC1/16S 683JTH	J24189047		1-	B	b2
R 2022	CHIP RES.	1k	1/16W	5%	RMC1/16S 102JTH	J24189025		1-	B	c2
R 2023	CHIP RES.	1k	1/16W	5%	RMC1/16S 102JTH	J24189025		1-	B	c2
R 2024	CHIP RES.	1k	1/16W	5%	RMC1/16S 102JTH	J24189025		1-	B	c2
R 2025	CHIP RES.	1k	1/16W	5%	RMC1/16S 102JTH	J24189025		1-	B	c2
R 2026	CHIP RES.	1k	1/16W	5%	RMC1/16S 102JTH	J24189025		1-	B	c2
R 2027	CHIP RES.	1k	1/16W	5%	RMC1/16S 102JTH	J24189025		1-	B	d2
R 2028	CHIP RES.	1k	1/16W	5%	RMC1/16S 102JTH	J24189025		1-	B	d2
R 2029	CHIP RES.	1k	1/16W	5%	RMC1/16S 102JTH	J24189025		1-	B	c2
R 2030	CHIP RES.	1k	1/16W	5%	RMC1/16S 102JTH	J24189025		1-	B	c2
R 2031	CHIP RES.	1k	1/16W	5%	RMC1/16S 102JTH	J24189025		1-	B	d2
R 2032	CHIP RES.	1k	1/16W	5%	RMC1/16S 102JTH	J24189025		1-	B	d2
R 2033	CHIP RES.	1k	1/16W	5%	RMC1/16S 102JTH	J24189025		1-	B	c2
R 2034	CHIP RES.	1k	1/16W	5%	RMC1/16S 102JTH	J24189025		1-	B	d2
R 2035	CHIP RES.	1k	1/16W	5%	RMC1/16S 102JTH	J24189025		1-	B	d2
R 2036	CHIP RES.	1k	1/16W	5%	RMC1/16S 102JTH	J24189025		1-	B	d2
R 2037	CHIP RES.	1k	1/16W	5%	RMC1/16S 102JTH	J24189025		1-	B	d2
R 2038	CHIP RES.	1k	1/16W	5%	RMC1/16S 102JTH	J24189025		1-	B	d2
R 2039	CHIP RES.	1k	1/16W	5%	RMC1/16S 102JTH	J24189025		1-	B	d2
R 2040	CHIP RES.	1k	1/16W	5%	RMC1/16S 102JTH	J24189025		1-	B	d2
R 2041	CHIP RES.	1k	1/16W	5%	RMC1/16S 102JTH	J24189025		1-	B	d2
R 2042	CHIP RES.	1k	1/16W	5%	RMC1/16S 102JTH	J24189025		1-	B	d2
R 2043	CHIP RES.	1k	1/16W	5%	RMC1/16S 102JTH	J24189025		1-	B	d2
R 2044	CHIP RES.	1k	1/16W	5%	RMC1/16S 102JTH	J24189025		1-	B	d2
R 2045	CHIP RES.	1k	1/16W	5%	RMC1/16S 102JTH	J24189025		1-	B	e2
R 2046	CHIP RES.	1k	1/16W	5%	RMC1/16S 102JTH	J24189025		1-	B	d2
R 2047	CHIP RES.	1k	1/16W	5%	RMC1/16S 102JTH	J24189025		1-	B	d2
R 2048	CHIP RES.	1k	1/16W	5%	RMC1/16S 102JTH	J24189025		1-	B	d2
R 2049	CHIP RES.	1k	1/16W	5%	RMC1/16S 102JTH	J24189025		1-	B	d2
R 2050	CHIP RES.	1k	1/16W	5%	RMC1/16S 102JTH	J24189025		1-	B	d2
R 2051	CHIP RES.	1k	1/16W	5%	RMC1/16S 102JTH	J24189025		1-	B	d2
R 2052	CHIP RES.	1k	1/16W	5%	RMC1/16S 102JTH	J24189025		1-	B	d2
R 2053	CHIP RES.	22k	1/16W	5%	RMC1/16S 223JTH	J24189041		1-	B	d2
R 2054	CHIP RES.	22k	1/16W	5%	RMC1/16S 223JTH	J24189041		1-	B	d2
R 2055	CHIP RES.	47k	1/16W	5%	RMC1/16S 473JTH	J24189045		1-	B	d2
R 2056	CHIP RES.	100k	1/16W	5%	RMC1/16S 104JTH	J24189049		1-	B	e2
R 2057	CHIP RES.	47k	1/16W	5%	RMC1/16S 473JTH	J24189045		1-	B	f2
R 2058	CHIP RES.	47k	1/16W	5%	RMC1/16S 473JTH	J24189045		1-	B	e2
R 2059	CHIP RES.	120	1/16W	5%	RMC1/16S 121JTH	J24189014		1-	B	a2
R 2060	CHIP RES.	120	1/16W	5%	RMC1/16S 121JTH	J24189014		1-	B	a2
R 2061	CHIP RES.	120	1/16W	5%	RMC1/16S 121JTH	J24189014		1-	B	b2
R 2062	CHIP RES.	120	1/16W	5%	RMC1/16S 121JTH	J24189014		1-	B	b2
R 2063	CHIP RES.	560	1/16W	5%	RMC1/16S 561JTH	J24189022		1-	B	c2
R 2064	CHIP RES.	560	1/16W	5%	RMC1/16S 561JTH	J24189022		1-	B	c2
R 2065	CHIP RES.	2.2k	1/16W	5%	RMC1/16S 222JTH	J24189029		1-	B	c2
R 2066	CHIP RES.	470	1/16W	5%	RMC1/16S 471JTH	J24189021		1-	B	d2
R 2067	CHIP RES.	1M	1/16W	5%	RMC1/16S 105JTH	J24189061		1-	B	d2
R 2069	CHIP RES.	10	1/16W	5%	RMC1/16S 100JTH	J24189001		1-	B	c2
R 2070	CHIP RES.	10	1/10W	5%	RMC1/10T 100J	J24205100		1-	B	f2
R 2071	CHIP RES.	100k	1/16W	5%	RMC1/16S 104JTH	J24189049		1-	B	d2
R 2072	CHIP RES.	100k	1/16W	5%	RMC1/16S 104JTH	J24189049		1-	B	d2
R 2073	CHIP RES.	1k	1/16W	5%	RMC1/16S 102JTH	J24189025		1-	B	d2
R 2074	CHIP RES.	1k	1/16W	5%	RMC1/16S 102JTH	J24189025		1-	B	d2
R 2075	CHIP RES.	1k	1/16W	5%	RMC1/16S 102JTH	J24189025		1-	B	e2
R 2076	CHIP RES.	1k	1/16W	5%	RMC1/16S 102JTH	J24189025		1-	B	d2
R 2077	CHIP RES.	56k	1/16W	5%	RMC1/16S 563JTH	J24189046		1-	B	e2
R 2078	CHIP RES.	100k	1/16W	5%	RMC1/16S 104JTH	J24189049		1-	B	e2
R 2079	CHIP RES.	330	1/16W	5%	RMC1/16S 331JTH	J24189019		1-	B	c2
R 2080	CHIP RES.	330	1/16W	5%	RMC1/16S 331JTH	J24189019		1-	B	c2
R 2081	CHIP RES.	100k	1/16W	5%	RMC1/16S 104JTH	J24189049		1-	B	d2
R 2082	CHIP RES.	100k	1/16W	5%	RMC1/16S 104JTH	J24189049		1-	B	d2
R 2083	CHIP RES.	100k	1/16W	5%	RMC1/16S 104JTH	J24189049		1-	B	d2
R 2084	CHIP RES.	1k	1/16W	5%	RMC1/16S 102JTH	J24189025		1-	B	d2
R 2085	CHIP RES.	1k	1/16W	5%	RMC1/16S 102JTH	J24189025		1-	B	d2
R 2086	CHIP RES.	1k	1/16W	5%	RMC1/16S 102JTH	J24189025		1-	B	d2
R 2087	CHIP RES.	56k	1/16W	5%	RMC1/16S 563JTH	J24189046		1-	B	b2
S 2001	ROTARY ENCODER				EC12E2424404	Q9000788		1-	A	A2
S 2002	ROTARY ENCODER				EC12E2424404	Q9000788		1-	A	G2
S 2003	TACT SWITCH				SKQMAL	N5090105		1-	A	D2
S 2004	TACT SWITCH				SKQMAL	N5090105		1-	A	C2

REF	DESCRIPTION	VALUE	V/W	TOL.	MFR'S DESIG	VXSTD P/N	VERS.	LOT	SIDE	LAY ADR
S 2005	TACT SWITCH				SKQMAL	N5090105		1-	A	C2
S 2006	TACT SWITCH				SKQMAL	N5090105		1-	A	B2
S 2007	TACT SWITCH				SKQMAL	N5090105		1-	A	B2
S 2008	TACT SWITCH				SKQMAL	N5090105		1-	A	E2
S 2009	TACT SWITCH				SKQMAL	N5090105		1-	A	D2
S 2010	TACT SWITCH				SKQMAL	N5090105		1-	A	E2
S 2011	TACT SWITCH				SKQMAL	N5090105		1-	A	F2
S 2012	TACT SWITCH				SKQMAL	N5090105		1-	A	B2
S 2013	TACT SWITCH				SKQMAL	N5090105		1-	A	A2
S 2014	TACT SWITCH				SKQMAL	N5090105		1-	A	A2
S 2015	TACT SWITCH				SKQMAL	N5090105		1-	A	F2
S 2016	TACT SWITCH				SKQMAL	N5090105		1-	A	F2
S 2017	TACT SWITCH				SKQMAL	N5090105		1-	A	F2
X 2001	XTAL CSA-310	3.6864MHz			3.6864MHZ	H0102988		1-	B	d2

PANEL Unit

Note:

Circuit Diagram

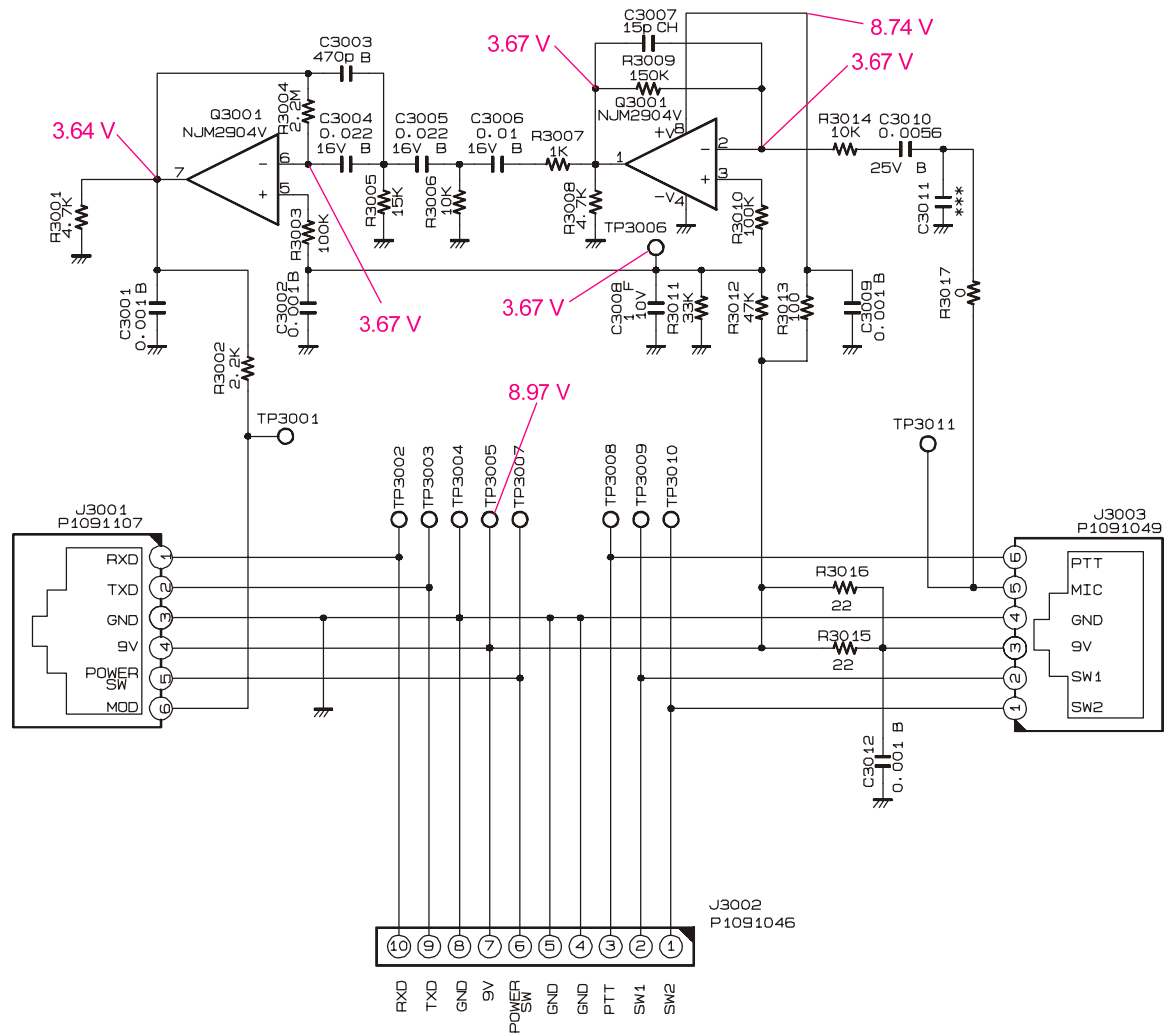

PANEL-SUB Unit

Parts Layout

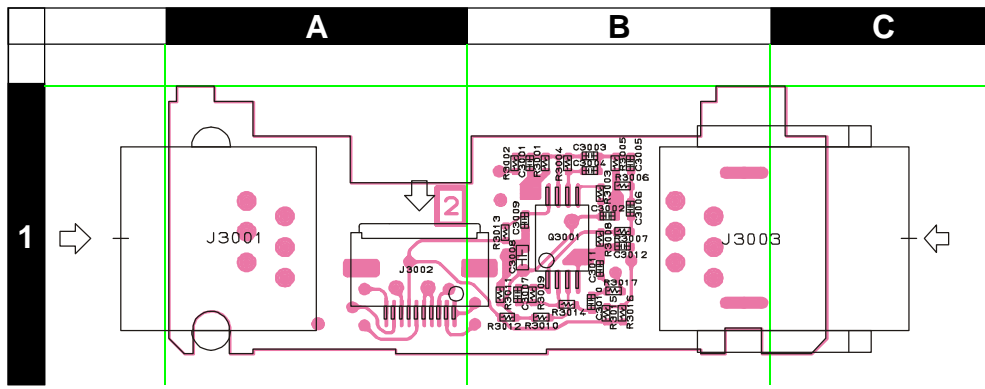

Side A

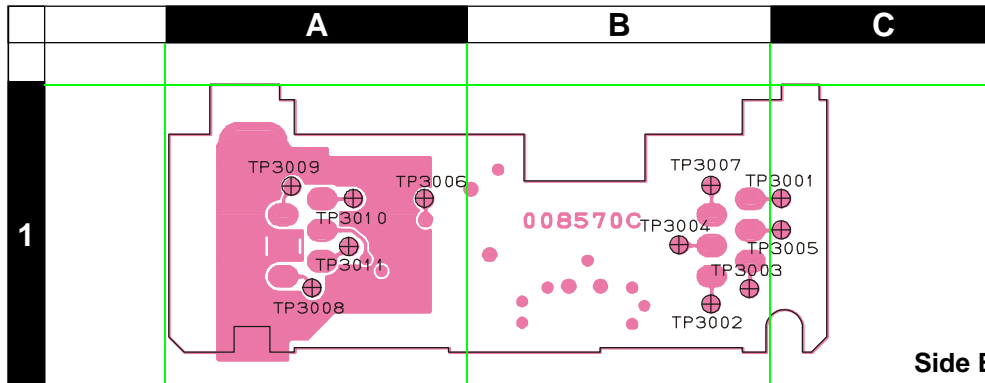

Side B

Parts List

REF	DESCRIPTION	VALUE	V/W	TOL.	MFR'S DESIG	VXSTD P/N	VERS.	LOT	SIDE	LAY ADR
PCB with Components						CB2514002	DST: USA			
						CB2514003	DST: EXP			
						CB2514004	DST: AUS			
Printed Circuit Board					AH008M000	FR0085700		1-		
C 3001	CHIP CAP.	0.001uF	50V	B	GRM36B102K50PT	K22178809		1-	A	B1
C 3002	CHIP CAP.	0.001uF	50V	B	GRM36B102K50PT	K22178809		1-	A	B1
C 3003	CHIP CAP.	470pF	50V	B	GRM36B471K50PT	K22178805		1-	A	B1
C 3004	CHIP CAP.	0.022uF	16V	B	GRM36B223K16PT	K22128806		1-	A	B1
C 3005	CHIP CAP.	0.022uF	16V	B	GRM36B223K16PT	K22128806		1-	A	B1
C 3006	CHIP CAP.	0.01uF	16V	B	GRM36B103K16PT	K22128804		1-	A	B1
C 3007	CHIP CAP.	15pF	50V	CH	GRM36CH150J50PT	K22178216		1-	A	B1
C 3008	CHIP CAP.	1uF	10V	F	GRM39F105Z10PT	K22105001		1-	A	B1
C 3009	CHIP CAP.	0.001uF	50V	B	GRM36B102K50PT	K22178809		1-	A	B1
C 3010	CHIP CAP.	0.0056uF	25V	B	GRM36B562K50PT	K22148802		1-	A	B1
C 3012	CHIP CAP.	0.001uF	50V	B	GRM36B102K50PT	K22178809		1-	A	B1
J 3001	CONNECTOR				NTC-623PCBL6-B	P1091107		1-	A	A1
J 3002	CONNECTOR				IL-FHR-10S-HF-E3000	P1091046		1-	A	A1
J 3003	CONNECTOR				MJ-66J-RD315K	P1091049		1-	A	C1
Q 3001	IC				NJM2904V-TE1	G1091677		1-	A	B1
R 3001	CHIP RES.	4.7k	1/16W	5%	RMC1/16S 472JTH	J24189033		1-	A	B1
R 3002	CHIP RES.	2.2k	1/16W	5%	RMC1/16S 222JTH	J24189029		1-	A	B1
R 3003	CHIP RES.	100k	1/16W	5%	RMC1/16S 104JTH	J24189049		1-	A	B1
R 3004	CHIP RES.	2.2M	1/16W	5%	RMC1/16S 225JTH	J24189065		1-	A	B1
R 3005	CHIP RES.	15k	1/16W	5%	RMC1/16S 153JTH	J24189039		1-	A	B1
R 3006	CHIP RES.	10k	1/16W	5%	RMC1/16S 103JTH	J24189037		1-	A	B1
R 3007	CHIP RES.	1k	1/16W	5%	RMC1/16S 102JTH	J24189025		1-	A	B1
R 3008	CHIP RES.	4.7k	1/16W	5%	RMC1/16S 472JTH	J24189033		1-	A	B1
R 3009	CHIP RES.	150k	1/16W	5%	RMC1/16S 154JTH	J24189051		1-	A	B1
R 3010	CHIP RES.	100k	1/16W	5%	RMC1/16S 104JTH	J24189049		1-	A	B1
R 3011	CHIP RES.	33k	1/16W	5%	RMC1/16S 333JTH	J24189043		1-	A	B1
R 3012	CHIP RES.	47k	1/16W	5%	RMC1/16S 473JTH	J24189045		1-	A	B1
R 3013	CHIP RES.	100	1/16W	5%	RMC1/16S 101JTH	J24189013		1-	A	B1
R 3014	CHIP RES.	10k	1/16W	5%	RMC1/16S 103JTH	J24189037		1-	A	B1
R 3015	CHIP RES.	22	1/16W	5%	RMC1/16S 220JTH	J24189005		1-	A	B1
R 3016	CHIP RES.	22	1/16W	5%	RMC1/16S 220JTH	J24189005		1-	A	B1
R 3017	CHIP RES.	0	1/16W	5%	RMC1/16S JPTH	J24189070		1-	A	B1

Circuit Diagram

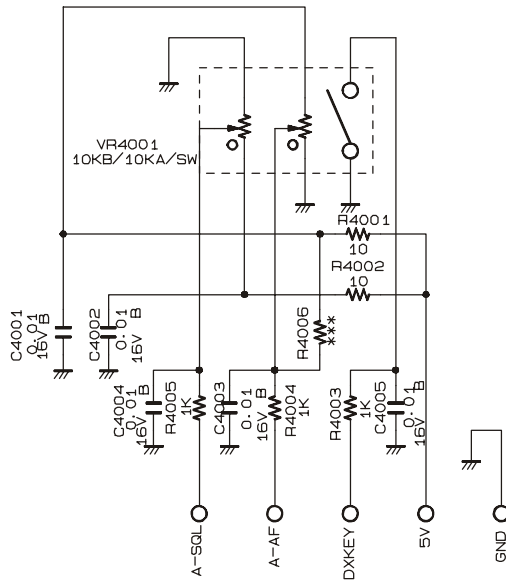

Parts Layout

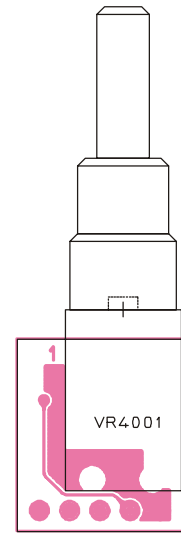

Side A

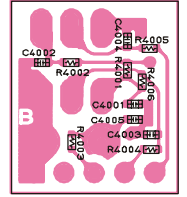

Side B

Parts List

REF	DESCRIPTION	VALUE	V/W	TOL.	MFR'S DESIG	VXSTD P/N	VERS.	LOT	SIDE	LAY ADR
PCB with Components						CB2515001				
Printed Circuit Board					AH018M000	FR0085800		1-		
C 4001	CHIP CAP.	0.01uF	16V	B	GRM36B103K16PT	K22128804		1-	B	a1
C 4002	CHIP CAP.	0.01uF	16V	B	GRM36B103K16PT	K22128804		1-	B	a1
C 4003	CHIP CAP.	0.01uF	16V	B	GRM36B103K16PT	K22128804		1-	B	a1
C 4004	CHIP CAP.	0.01uF	16V	B	GRM36B103K16PT	K22128804		1-	B	a1
C 4005	CHIP CAP.	0.01uF	16V	B	GRM36B103K16PT	K22128804		1-	B	a1
P 4000	WIRE ASSY				AH008M	T9206998		1-		
R 4001	CHIP RES.	10	1/16W	5%	RMC1/16S 100JTH	J24189001		1-	B	a1
R 4002	CHIP RES.	10	1/16W	5%	RMC1/16S 100JTH	J24189001		1-	B	a1
R 4003	CHIP RES.	1k	1/16W	5%	RMC1/16S 102JTH	J24189025		1-	B	a1
R 4004	CHIP RES.	1k	1/16W	5%	RMC1/16S 102JTH	J24189025		1-	B	a1
R 4005	CHIP RES.	1k	1/16W	5%	RMC1/16S 102JTH	J24189025		1-	B	a1
R 4006	CHIP RES.	22k	1/16W	5%	RMC1/16S 223JTH	J24189041		1	B	a1
R 4006	CHIP RES.	2.2k	1/16W	5%	RMC1/16S 222JTH	J24189029		2-	B	a1
VR4001	POT.				TP76D00A 10KB/10KB/SW	J62800140		1-	A	A1

VR-R Unit

Circuit Diagram

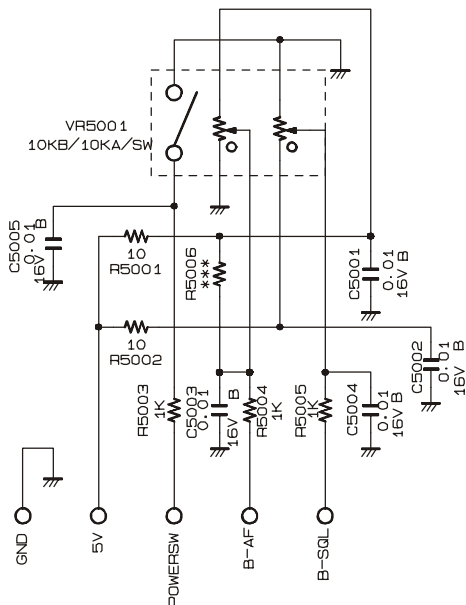

Parts Layout

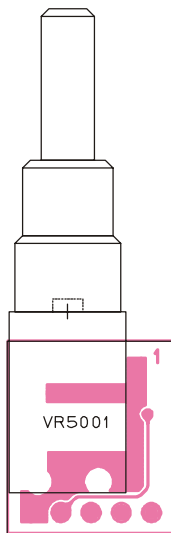

Side A

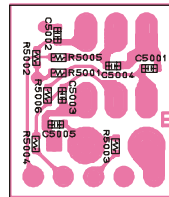

Side B

Parts List

REF	DESCRIPTION	VALUE	V/W	TOL.	MFR'S DESIG	VXSTD P/N	VERS.	LOT	SIDE	LAY ADR
PCB with Components						CB2516001				
Printed Circuit Board						AH008M000	FR0085900	1-		
C 5001	CHIP CAP.	0.01uF	16V	B	GRM36B103K16PT	K22128804		1-	B	a1
C 5002	CHIP CAP.	0.01uF	16V	B	GRM36B103K16PT	K22128804		1-	B	a1
C 5003	CHIP CAP.	0.01uF	16V	B	GRM36B103K16PT	K22128804		1-	B	a1
C 5004	CHIP CAP.	0.01uF	16V	B	GRM36B103K16PT	K22128804		1-	B	a1
C 5005	CHIP CAP.	0.01uF	16V	B	GRM36B103K16PT	K22128804		1-	B	a1
P 5000	WIRE ASSY				AH008M	T9206998		1-		
R 5001	CHIP RES.	10	1/16W	5%	RMC1/16S 100JTH	J24189001		1-	B	a1
R 5002	CHIP RES.	10	1/16W	5%	RMC1/16S 100JTH	J24189001		1-	B	a1
R 5003	CHIP RES.	1k	1/16W	5%	RMC1/16S 102JTH	J24189025		1-	B	a1
R 5004	CHIP RES.	1k	1/16W	5%	RMC1/16S 102JTH	J24189025		1-	B	a1
R 5005	CHIP RES.	1k	1/16W	5%	RMC1/16S 102JTH	J24189025		1-	B	a1
VR5001	POT.				TP76D00A 10KB/10KB/SW	J62800140		1-	A	A1



Copyright 2003
VERTEX STANDARD CO., LTD.
All rights reserved.

No portion of this manual
may be reproduced
without the permission of
VERTEX STANDARD CO., LTD.